

# commodore

the **microcomputer** magazine

Volume 4, Number 6, Issue 27  
\$2.50 U.S.  
\$3.50 Canada  
ISSN 0774-8724

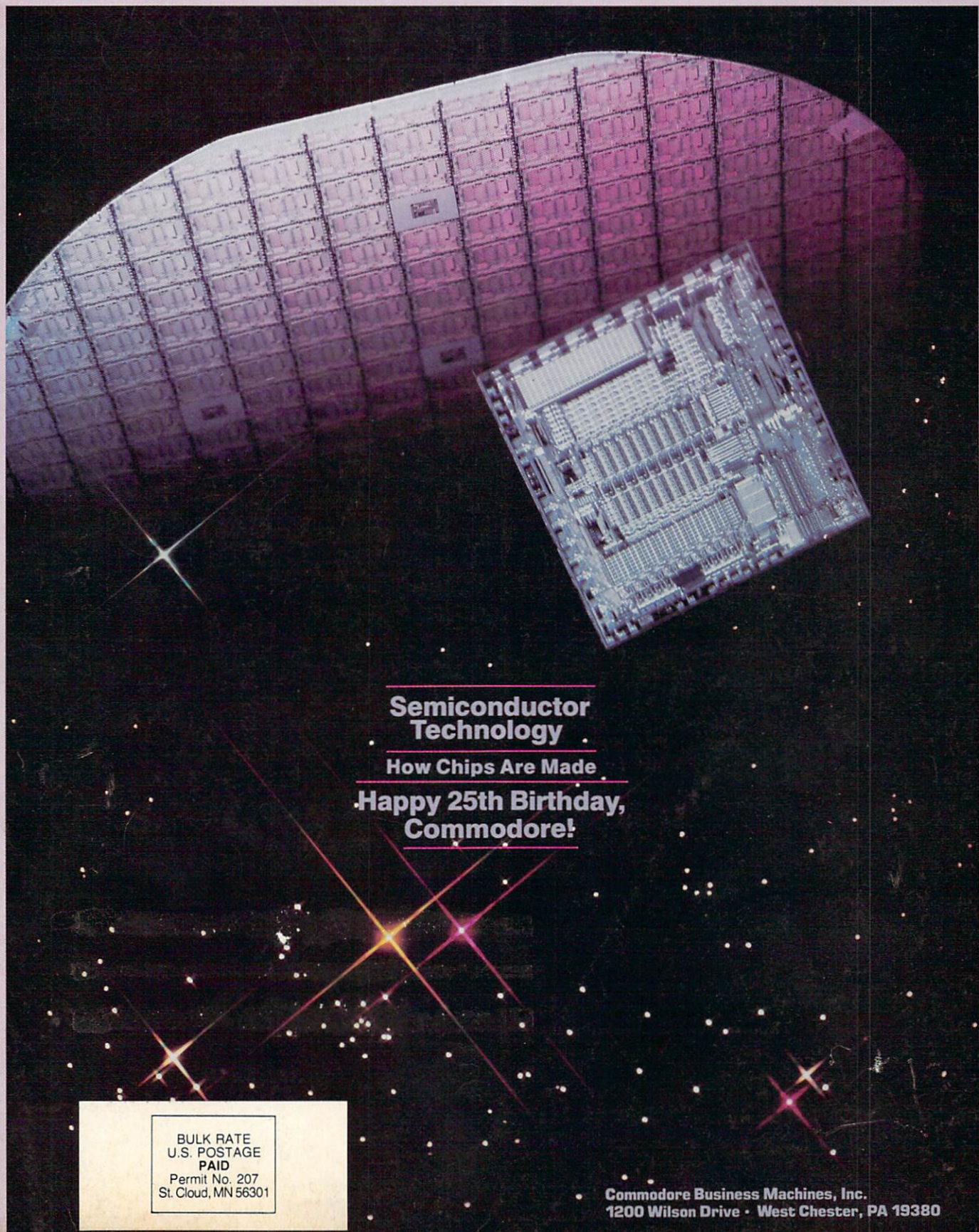

## Semiconductor Technology

How Chips Are Made

Happy 25th Birthday,  
Commodore!

BULK RATE  
U.S. POSTAGE  
PAID  
Permit No. 207  
St. Cloud, MN 56301

Commodore Business Machines, Inc.  
1200 Wilson Drive • West Chester, PA 19380



# COMMODORE BOOKWARE



## Hardware... Software... BOOKWARE

Commodore offers you complete support for your home computer. To complement your Commodore hardware and software, we have a full range of "teach yourself" programming and instructional books. From "create your own graphics and music" to extensive computer language programming, Commodore meets your computer needs.

The Commodore Software Encyclopedia is an indispensable guide for worldwide Commodore software.

From beginner to business professional Commodore Books are valuable additions to your computer library.

 **commodore**  
COMPUTERS

**First In Quality Software**



# Don't let price get in the way of owning a quality printer.

Adding a printer to your computer makes sense. But deciding which printer to add can be tricky. Do you settle for a printer with limited functions and an inexpensive price tag or buy a more versatile printer that costs more than your computer? Neither choice makes sense.

Here's a refreshing option—the new, compact STX-80 printer from Star Micronics. It's the under \$200 printer that's whisper-quiet, prints 60 cps and is ready to run with most popular personal computers.

The STX-80 has deluxe features you would

expect in higher priced models. It prints a full 80 columns of crisp, attractive characters with true descenders, foreign language characters and special symbols. It offers both finely detailed dot-addressable graphics and block graphics.

And, of course, the STX-80 comes with Star Micronics' 180 day warranty (90 days on the print element).

The STX-80 thermal printer from Star Micronics. It combines high performance with a very low price. So now, there is nothing in the way of owning a quality printer.

\*Manufacturer's suggested retail price.

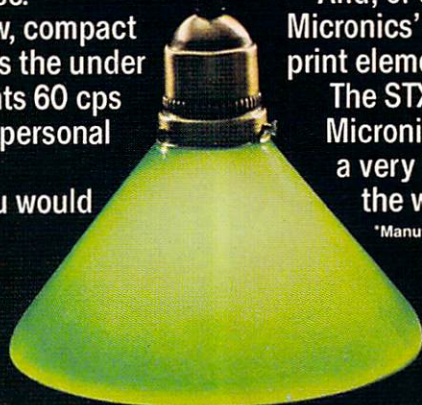

**star**<sup>TM</sup>  
MICRONICS • INC

**THE POWER BEHIND THE PRINTED WORD.**

Computer Peripherals Division, 1120 Empire Central Place, Suite 216, Dallas, TX 75247 (214) 631-8560



# The new STX-80 printer for only \$199.\*



## features

Volume 4, Number 6, Issue 27



In the Chips



The Microchip



Bits and Pieces

---

**34 In the Chips** by Diane LeBold  
Where microchips came from and how they are made.

---

**45 Millions and the Microchip** by Jim Gracely  
How many times is a million times a second? Jim takes a look at the scales of time and size as they relate to your computer.

---

**48 The Logic of Bits and Pieces** by Jeff Hand  
Part 2 in Jeff's series explains two-state logic and how it works in your computer.

---

**54 6502 Op-Codes**  
For the more technical among you, we've provided a list of all the 6502 op-codes with a description of what they do and how they affect the status register.

---

## departments

---

**14 Editor's Notes**

---

**15 Letters**  
Our readers offer opinions and advice

---

**17 Commodore News**  
**Happy 25th Birthday Commodore!** by Leslie Wood

---

**22 Business**  
**Spread Sheet Programs: Expensive Gimmicks or Management Tools?** by Donald Hassler

---

**24 Education**  
**Lincoln College Commodore Computer Camp**  
by Tom Zurkammer  
**The Commuting Commodore** by Doris Dickenson  
**Educational Programming: A Method** by M. W. Caprio

---





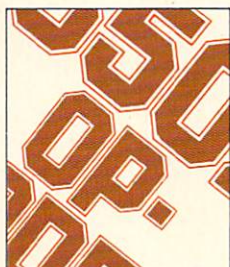

6502 Op-Codes

- 
- 61 Program Review**  
*Easy Spell 64* by Mark Cornacchio
- 
- 62 The Arts**  
**Creating and Photographing Computer Screens**  
by Brooks Cooley
- 
- 64 Programmer's Tips**  
**On the Merits of Touching Up the X-Rays** by Elizabeth Deal  
**Random Thoughts, Part 3** by Mark Zimmermann  
**Using Picture Format** by F. H. Shedd  
**Prints Charming** by Andy Gamble
- 
- 87 Computer Languages**  
**COMAL Graphics** by Len Lindsay
- 
- 95 Product Review**  
**Promqueen 64** by Jeff Bruette
- 
- 96 Technical**  
**A Theory of Operation for the VIC/64 Boards** by Jim Gracely
- 
- 99 Telecommunications**  
**The New Commodore Information Network** by Barbara Karpinski  
**The Model 1650 AUTOMODEM** by James E. Darrough
- 
- 104 User Departments**  
**Commodore 64**  
**Commodore 64 Sprite Mover** by Elizabeth Deal  
**PET/CBM**  
**Go Directly to XY!** by David Bull
- 
- 115 Commodore User Groups**  
**User Group Listing**  
User groups across the nation and around the world.  
**User Bulletin Board**  
Messages from user groups to user groups.
- 
- 121 That Does Not Compute . . .**  
When we make a mistake, this is where we fix it.
- 
- 126 New Products**  
What's new from independent manufacturers.
- 
- 128 Advertisers Index**
-



**Publishing Manager**

Neil Harris

**Editor**

Diane LeBold

**Technical Editor**

Jim Gracely

**Staff Writers**Jeff Bruette  
Brooks Cooley  
Mark Comacchio  
Barbara Karpinski  
April Koppenhaver**Contributing Writers**David Bull  
M.W. Caprio  
James E. Darrough  
Elizabeth Deal  
Doris Dickenson  
Andy Gamble  
Jeff Hand  
Donald Hassler  
Len Lindsay  
F.H. Shedd  
Leslie Wood  
Mark Zimmermann  
Tom Zurkammer**Technical Staff**Barbara Karpinski  
April Koppenhaver  
Cyndie Merten  
Sarah Meyer  
Stephen Murri**Circulation Manager**

John O'Brien

**Circulation Assistant**

Kathy Reigel

**Advertising Coordinator**

Sharon Steinhofner

**Graphic Design**Neumann Greenberg Schlenker  
King of Prussia, Pennsylvania**Cover Photo**

Bob Emmott

**Typography**Associates International, Inc.  
Wilmington, Delaware**Printing**Volkmuth Printers  
St. Cloud, Minnesota

ISBN 0-88731-005-2

VIC 20™, Commodore 64™ and SuperPET™ are trademarks of Commodore Electronics Ltd. PET® is a registered trademark of Commodore Business Machines, Inc. CBM® is a registered trademark of Commodore Electronics Ltd.

Commodore: The Microcomputer Magazine is published six times a year by the Computer Systems Division, Commodore Business Machines, Inc., 1200 Wilson Drive, West Chester, Pennsylvania 19380. Copyright 1983® by Commodore Electronics Ltd. All rights reserved. No material may be reprinted without permission. Volume IV, Number 6, Issue 27.

Subscription Information: U.S. subscriber rate is \$15.00 per year. Canadian subscriber rate is \$20.00 per year. Overseas \$25.00. To order phone 800-345-8112 (In Pennsylvania 800-662-2444).

## Our 1984 Issues Continue to Bring You the Best Information Straight from the Source!

**Commodore: the Micro-computer Magazine**, Issue 28: More up-to-the-minute information for Commodore enthusiasts—programming tips; applications in education, business, the arts and the home; product reviews; user groups—and maybe a few surprises! Look for us in February.

**Power/Play**, Spring: On the lighter side of Commodore computing, *Power/Play* continues to bring you program listings, information on the Commodore Kids, learning at home, entertainment, home applications and more. We'll be out there in March with all the computing fun you can handle.

## Key to Entering Program Listings

" [F1, F2, F3, F4, F5, F6, F7, F8] ": F1, F2, F3, F4, F5, F6, F7 AND F8  
" [POUND] ": ENGLISH POUND  
" [PI] " PI SYMBOL  
" ^ ": UP ARROW  
" [HOME] ": UNSHIFTED CLR/HOME  
" [CLEAR] ": SHIFTED CLR/HOME  
" [RVS] ": REVERSE ON  
" [RVOFF] ": REVERSE OFF  
" [BLACK, WHITE, RED, CYAN, MAGENTA, GREEN, BLUE, YELLOW] " THE 8 CTRL KEY COLORS  
" [ORANGE, BROWN, L. RED, GRAY 1, GRAY 2, L. GREEN, L. BLUE, GRAY 3] ": THE 8 COMMODORE KEY COLORS (ONLY ON THE 64)  
GRAPHIC SYMBOLS WILL BE REPRESENTED AS EITHER THE LETTERS SHFT (SHIFT KEY) AND A KEY: "[SHFT Q, SHFT K, SHFT V, SHFT T, SHFT L]" OR THE LETTERS CMDR (COMMODORE KEY) AND A KEY: "[CMDR Q, CMDR H, CMDR S, CMDR N, CMDR O]"  
IF A SYMBOL IS REPEATED, THE NUMBER OF REPITITIONS WILL BE DIRECTLY AFTER THE KEY AND BEFORE THE COMMA: "[SPACE3, SHFT S4, CMDR M2]"





# Stop Gambling. Start Winning. Now.

It's a fact. You will beat the dealer if you play Blackjack correctly. In Las Vegas. In Atlantic City. In dozens of foreign countries throughout the world.

They haven't changed the rules. Even multiple-deck games pose no problem if you play properly. You can win just as easily in 1983 as you could in 1961 when the first Blackjack strategies were created.

This ad is your cue to join the small group of Blackjack players who are no longer gambling. Become a strategy player and win. Consistently.

### The Obstacle

Despite the wild claims made by the Blackjack system charlatans, it is not possible to learn an effective strategy overnight. Learning an effective strategy takes time and discipline. If learning a strategy were easy, everyone would be making a living playing Blackjack. As it stands, less than one percent play well enough to make money.

### The Solution

BLACKJACK TEACHER simulates, in precise detail, the events that transpire in actual casino play. The display screen depicts the top view of a Blackjack table. You interact with the program just as you would an actual game. Computer controlled players occupy adjacent seats. All events occur in real-time.

BLACKJACK TEACHER teaches seven different strategies of varying complexity and accuracy. This spectrum of strategies allows you to select a strategy that suits your needs.

BLACKJACK TEACHER monitors your betting and strategy decisions (hit/stand/double/split/insurance). If your decisions are incorrect within the guidelines of your strategy, the system will display error messages showing you the correct decisions.

BLACKJACK TEACHER is the result of over ten years of Blackjack research. The strategies encompassed by the system were developed using computers. The more complex strategies are among the most powerful ever devised.

Complete documentation is included which tells you everything you need to know to become an expert strategy player.

### The SOTA Story

SOTA Enterprises has consistently produced nothing less than the highest quality software. When you buy software from SOTA, we do our utmost to make sure you get your money's worth.

### ATTENTION VIC 20 USERS

A new version of BLACKJACK TEACHER is now available for the VIC 20. Although not as comprehensive as the original 32K program, the VIC 20 version does teach Basic Strategy - a must for the Blackjack strategy beginner!

### FILL OUT AND MAIL TODAY!

Name \_\_\_\_\_

Address \_\_\_\_\_

City \_\_\_\_\_

State \_\_\_\_\_ Zip \_\_\_\_\_

Make Check or Money Order Payable to:

**SOTA Enterprises, Inc.**  
833 Garfield Ave, Suite 101  
South Pasadena, CA 91030



### Check Box

- VIC 20 (\$19.95)
- COMMODORE 64 (\$49.95)
- PET (32K) (\$49.95)
- PET 2001 (32K) (\$49.95)
- CBM 4032 (\$49.95)

### Media

- Cassette
- Disc

Include \$2.50 Postage and Handling • California Residents add 6½% Sales Tax





commodore  64

# INDISPENSABLE SOFTWARE

For Your Most Important Computing Needs

Commodore is your best value in practical software—just take a look at the programs shown here—we've got everything from wordprocessing to business accounting, from electronic spreadsheets to computer graphics. Use the Software Selection Guide to find the programs which best meet your needs, then see your Commodore dealer!



**EasyScript 64**  
Displays 764 lines x 240 characters. Prints to 130 columns. Works with EasySpell 64.



**EasySpell 64**  
20,000 word Master Dictionary and automatic spelling checker. Works with EasyScript 64.

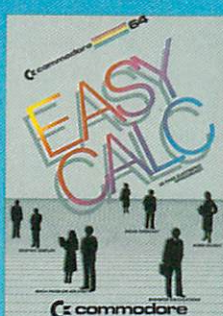

**EasyCalc 64**  
Multiple electronic spreadsheet with color bar graph feature. 63 columns x 254 rows.

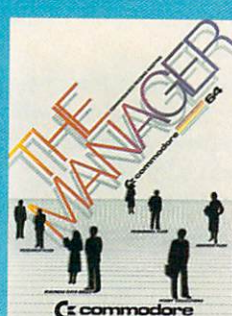

**The Manager**  
Sophisticated database system with 4 built-in applications, or design your own. Text, formulas, graphics.

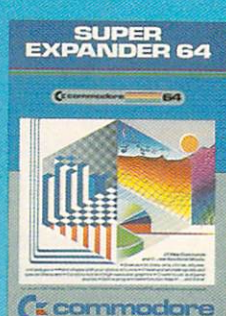

**SuperExpander 64**  
21 special commands. Combine text with high resolution graphics. Music and game sounds.



**Easy Finance I—Loan Analysis**  
12 loan functions. Bar graph forecasting as well as calculation.



**Easy Finance II—Basic Investment Analysis**  
16 stock investment functions. Investment bar graph.



**Easy Finance III—Advanced Investment Analysis**  
16 capital investment functions. Bar graphs.



**Easy Finance IV—Business Management**  
21 business management features. Bar graphs.

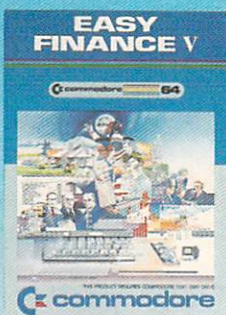

**Easy Finance V—Statistics and Forecasting**  
Assess present/future sales trends with 9 statistics and forecasting functions.

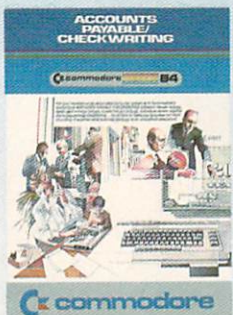

**Accounts Payable/Checkwriting**  
11 functions. Automatic billing. 50 vendors/disk.



**Accounts Receivable/Billing**  
11 billing functions. Printed statements.



**General Ledger**  
8 general ledger options. Custom income statement, trial balances, reports.



**Inventory Management**  
1000 inventory items. Full reports.



**Payroll**  
24 different payroll functions. Integrated with G/L system.



# SOFTWARE SELECTION GUIDE

APPLICATION	SOFTWARE
Budget/Calculation	EASYCALC 64
Business Accounting	ACCOUNTS PAYABLE/CHECKWRITING, ACCOUNTS RECEIVABLE/BILLING, GENERAL LEDGER, INVENTORY MANAGEMENT, PAYROLL
Business Management	EASYFINANCE IV—BUSINESS MANAGEMENT
Children's Programming	ZORTEK & THE MICROCHIPS
Cooking/Recipes	MICRO COOKBOOK
Data Base Management	THE MANAGER
Electronic Spreadsheet	EASYCALC 64
Filing/Recordkeeping	MAGIC DESK, THE MANAGER, INVENTORY MANAGEMENT
Financial Investments	EASYFINANCE II—BASIC INVESTMENT ANALYSIS, EASYFINANCE III—ADVANCED INVESTMENT ANALYSIS, FINANCIAL ADVISOR
Graphics/Sound	SUPEREXPANDER 64
Learn Programming	INTRODUCTION TO BASIC—PART 1
Loans/Mortgages	EASYFINANCE I—LOAN ANALYSIS, FINANCIAL ADVISOR
Mailing List	EASYMAIL 64
Music	MUSIC COMPOSER, MUSIC MACHINE
Programming Aids	SUPEREXPANDER 64, SCREEN EDITOR, ASSEMBLER 64
Reference Books	PROGRAMMERS REFERENCE GUIDE, SOFTWARE ENCYCLOPEDIA
Spelling Dictionary	EASYSPELL 64 (for use with EASYSCRIPT 64)
Statistics/Forecasting	EASYFINANCE V—STATISTICS & FORECASTING, EASYFINANCE IV—BUSINESS MANAGEMENT
Teacher's Aids	EASYLESSON/EASYQUIZ, LOGO, PILOT
Telecommunications	VICMODEM, AUTOMODEM, TERM 20/64, RS232 INTERFACE
Wordprocessing	EASYSCRIPT 64, MAGIC DESK, WORD MACHINE/NAME MACHINE

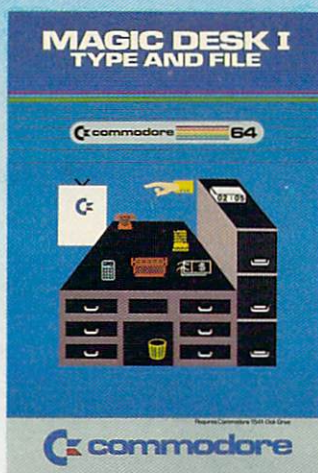

## MAGIC DESK I-TYPE & FILE

Only Commodore brings you the magic of MAGIC DESK... the next generation of "user-friendly" software! Imagine using your computer to type, file and edit personal letters and papers—without learning any special commands! All MAGIC DESK commands are PICTURES. Just move the animated hand to the picture of the feature you want to use (like the TYPEWRITER) and you're ready to go. MAGIC DESK is the "ultimate" in friendly software!



### Special "Help" Menus

Not only is MAGIC DESK easy to use... it's hard to make a mistake! Just press the COMMODORE key and one of several "help menus" appears to tell you exactly what to do next.

 **commodore**  
COMPUTERS

**First In Quality Software**



# THE BEST GAMES IN TOWN

## Arcade Action Games

**Pinball Spectacular:** Real pinball action and thrills. Sound you won't believe. Chutes, lights, bumpers and more.

**Supersmash:** Raquetball arcade classic. 3 games in 1. Many skill levels keep the challenge alive.

**Tooth Invaders:** Reviewed by American Dental Association. Arcade action teaches good dental care. Beat D.K. at all 9 play levels.

**Star Post:** Protect the Star Post from waves of invaders. 3 levels of skill. 99 levels of action.

**Avenger:** Destroy attacking aliens with laser cannons. Classic arcade action. Multi-speed attacks.

**Jupiter Lander:** Space landing simulation. Horizontal/vertical thrust. Soft-land scoring. Wow! animation.

**Radar Rat Race:** Beat the maze. Eat all the cheese. Beware deadly cats/rats. Cartoon action fun for all ages.

**Lemans:** Multi-obstacle road racing at its best. Arcade action and graphics. Night, water and divided highway hazards.

**Star Ranger:** Fight your way through hordes of space enemies. Avoid asteroids and land safely. Superb graphics and space action.

**Frogmaster:** Unique sports challenge. Train animals to play football and rugby. Over 100 variations. Play against, computer, friend or yourself.

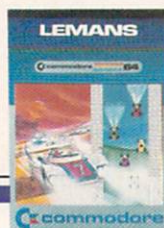
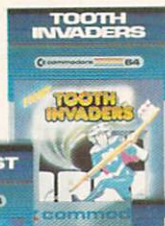
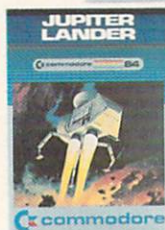

NEW  
NEW  
NEW  
NEW  
NEW

## Children's Series

**Introduction to Basic I:** Simple step-by-step instructions. Modular design. Practical BASIC applications as you learn.

**Zortek and the Microchips:** Award winning program teaches children BASIC through games, graphics and stories.

**Easy Lesson/Easy Quiz:** Take the drudgery out of writing tests and quizzes. Answer keys provided. 7 categories per test.

**Number Nabber/Shape Grabber:** 2 Learning games in 1. Build both math and object identification skills. Lively graphic and sound effects.

**Visible Solar System:** Fly the solar system. Land on planets. Calculate age and weight. Astronomy for home and school. Award winner.

**Speed/Bingo Math:** 2 games in 1 teach children 4 to 10 basic math skills. Beat the clock or your friends.

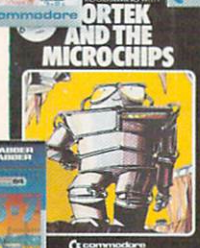
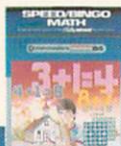

NEW



## Bally Midway

NEW

**Gorf:** 4 Space action games in 1. Fly your fighter defeat "The Empire". Multi-skill levels. IT TALKS! (with Magic Voice)

**Wizard of WOR:** Fight your way through 30+ mazes. Defeat the Wizard and Warriors. Multi-skill. IT TALKS! (with Magic Voice.) Award winning conversion.

**Seawolf:** The classic battle at sea. Destroy PT Boats and Destroyers. Great graphics and sound.

**Omega Race:** Fast space race action. Many skill levels. Avoid deadly mines as you eliminate droid forces.

**Clowns:** Amazing action under the "Big Top". Help clowns "pop" balloons. Colorful acrobatics. Fun for all.

**Kickman:** Ride the unicycle and catch falling objects. Multi-skill levels. Tunesful sound. Watch out! Don't fall!

**Blueprint:** Help J.J. build the "Ammo Machine". Parts are stored in a colorful maze of houses. Multi-skill and difficulty levels.

**Lazarian:** 4 different screens. Multi-skill level space action. Rescue, evade obstacles and destroy a one-eyed leviathan.

NEW

NEW



## Adventure Games

**Zork I:** Fantasy adventure in a dungeon. Find all the treasure and escape alive.

**Zork II:** This dungeon adventure dares you to find treasure and secret places and still survive.

**Zork III:** The ultimate dungeon test. Discover the Dungeon Master's secret purpose and come out alive.

**Suspended:** Awake in 500 years. Solve varied real and original puzzles to save the planet from total destruction.

**Starcross:** Travel through the mystery ship. Meet aliens friend and foe. Face the challenge of your destiny. Map of galaxy included.

**Deadline:** Find the murderer and solve the mystery all in 12 hours. Inspector casebook and evidence included.



## Music Series

**Music Machine:** Play piano or organ melodies and percussion rhythms together. Music staff shows notes on screen. Vibrato, tempo and pitch controls.

**Music Composer:** Create, play and save your tunes easily. Simulates up to 9 instruments. Notes appear on screen. Play your keyboard like a piano.



 **commodore**  
COMPUTERS

**First In Quality Software**



# VIC 20

# SUPER SOFTWARE SAVINGS

## Bally Midway

**Gorf:** 4 Space action games in 1. Fly your fighter defeat "The Empire". Multi-skill level.

**Seawolf:** The classic battle at sea. Destroy PT Boats and Destroyers. Great graphics and sound.

**Omega Race:** Fast space race action. Many skill levels. Avoid deadly mines as you eliminate droid forces.

**Clowns:** Amazing action under the "Big Top". Help clowns "pop" balloons.



## Lifestyle Series

**Quizmaster:** Write and give your own quizzes. Teach, revise, test and entertain.

**Know Your Child's I.Q.:** 3 Comprehensive tests. 100 questions. Auto and tamperproof scoring. Improve school test performance.

**Know Your Own I.Q.:** 4 I.Q. tests. 160 problems. Auto and tamperproof scoring. For hours of entertainment.

**Know Your Personality:** 3 In-depth personality tests. 450 questions. Auto scoring. Find your friends true feelings. For entertainment only.

**Robert Carrier's Menu Planner:** 120 meals and 20 wines start your menu data-base. Add your own recipes.



## Children's Games

**The Sky is Falling:** Pre-school and elementary age children help Chicken Little. Builds hand-eye coordination.

**Mole Attack:** Bop the nasty moles as they stick heads out of burrows. Cartoon graphics. Multi-speed action.

**Home Babysitter:** Building blocks teach the alphabet. Common objects teach numbers to 20. Plus funny face maker.

**Visible Solar System:** Fly the solar system. Land on planets. Calculate age and weight. Astronomy for home and school. Award winner.

**Speed/Bingo Math:** 2 games in 1 teach children 4 to 10 basic math skills.



## Business and Financial

**Personal Finance:** Four programs in one. Track expenses. Spending analysis. Budgets and deductibles.

**Simpicalc:** Electronic spreadsheet. 1200 entries. Design/repeat formulas and worksheets.

**VIC Writer:** Wordprocessing made simple. From 45 lines unexpanded to 1207 lines of text with 16K RAM PACK.

**Money Decisions I:** 7 Loan analysis functions. Principle, regular/last payment. Balance. Time period. Interest. Variable rate loan.

**Money Decisions II:** 9 investment functions. Future/Initial/Minimum Investment. Regular deposit/withdraw. Interest. Annuity Continuous compounding.





## Educational Programs

**Introduction to Basic I & II:** Simple step-by-step instructions. Practical BASIC applications.

**Zortek and the Microchips:** Award winning program teaches children BASIC through games, graphics and stories.

**Waterloo Basic:** The original course in VIC BASIC.

**Chopper Math:** Challenging helicopter landing game that teaches math basics.

**Easy Type:** Learn touch-typing the easy way.

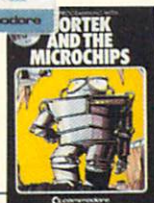
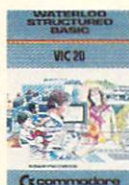

## Adventure Games

**Adventureland:** Fantasy adventures challenge you to get all the treasure and escape alive.

**Pirate Cove:** Find the long lost treasure of pirate John Silver. Uncover clues while battling foes.

**Atomic Mission:** Save the nuclear powerplant from destruction. Piece clues together—solve the mystery.

**The Count:** Make your way through the dungeon, collect treasure and kill Count Dracula.

**Voodoo Castle:** Find the Count of Monte Cristo and remove the deadly curse.

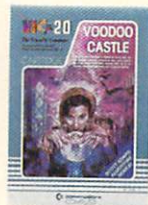

## Arcade Action Games

**VIC Avenger:** Destroy attacking aliens with laser cannons. Classic arcade action. Multi-speed attacks.

**Super Alien:** Trapped in an alien maze, your only defense is an alien buster. Hi-speed action.

**Superslot:** Vegas and Atlantic City casinos come home. Real slot machine action, graphics and sound.

**Jupiter Lander:** Space landing simulation. Horizontal/vertical thrust. Soft-land scoring.

**Draw Poker:** Casino style action. Betting. Sound effects.

**Road Race:** Night driving challenges you to the max. 4-speed shift. Stay on course. Don't overheat.

**Radar Rat Race:** Beat the maze. Eat all the cheese. Beware deadly cats/rats.

**Raid on Ft. Knox:** Sneak gold bars past deadly panthers and back to the hideout before time is up.

**Pinball Spectacular:** Space action and pinball thrills combined. Lights, bumpers, and special skill bonuses.

**Sargon II Chess:** Challenging chess strategy classic. Multi-skill levels from beginner to advanced.

**Supersmash:** Raquetball arcade classic. 3 games in 1. Many skill levels keep the challenge alive.

**Cosmic Cruncher:** Make your way through the Milky Way. 11 levels of play. Over 300 color/maze combinations.

**Money Wars:** Grab the money and run. 3 brick barricades are your protection as you dodge deadly bullets.

**Tooth Invaders:** Arcade action teaches good dental care. Beat D.K. at all 9 play levels.

**Star Post:** Protect the Star Post from waves of invaders. 3 levels of skill. 99 levels of action.



 **commodore**  
COMPUTERS

**First In Quality Software**



Commodore 64

# MAGIC DESK I

TYPE AND FILE



Only from Commodore—  
the excitement  
and simplicity of  
Magic Desk



Only Commodore brings you the magic of MAGIC DESK... the next generation of "user friendly" software! Imagine using your computer to type, file and edit personal letters and papers *without learning any special commands!* All MAGIC DESK commands are PICTURES. Just move the animated hand to the picture of the feature you want to use (like the TYPEWRITER) and you're ready to go.



The MAGIC DESK Typewriter works just like a real ELECTRIC TYPEWRITER... and it's COMPUTERIZED. All the filing is *electronic*. Excellent sound effects and screen animation make typing fun, whether you're typing letters, reports or memos... and the built-in filing feature makes MAGIC DESK useful for keeping names and addresses, home inventory lists, insurance information and more.



Your COMMODORE 64, COMMODORE DISK DRIVE and MAGIC DESK are an unbeatable combination. Filing operations are automatically linked to your Commodore disk drive—but you don't have to know any commands—just "file" the pages you type in the file cabinet and your text is automatically saved on diskette. There are 3 file drawers with 10 file folders in each drawer and 10 pages in each folder.



To PRINT a page you've typed, just "point" at the picture of the printer and your pages are automatically printed on your COMMODORE PRINTER or PRINTER/PLOTTER. If you want to erase what you've typed, the WASTE-BASKET under the desk lets you "throw away" pages. There's even a DIGITAL CLOCK which helps you keep track of time while you're typing.

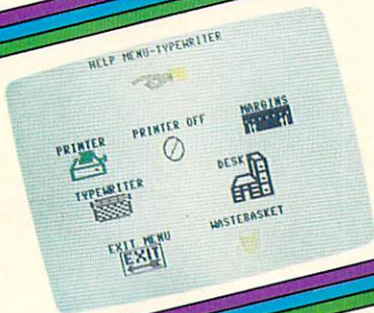

Not only is MAGIC DESK easy to use... it's hard to make a mistake! Just press the COMMODORE key and one of several "help" menus appears to tell you exactly what to do next. Special messages show you how the various picture commands work and help you when you make a mistake. Help messages also show you how to use the printer, filing cabinet, digital clock and wastebasket.

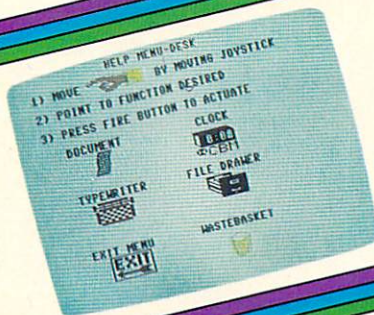

**Commodore**  
COMPUTERS  
First In Quality Software



# Commodore Celebrates Its Silver Anniversary

The big news this month is the "World of Commodore" show in Toronto, Commodore's birthplace, in honor of the company's twenty-fifth birthday. Since many readers have asked us to publish a history of the company we thought this was the opportune time. You'll find it on page 17. We hope it answers a lot of the questions that may have been rattling around in your mind about the "upstart" company that ended up as number one in this highly competitive industry.

Coincidentally, this is also the issue that takes you through MOS Technology, Inc., the subsidiary of Commodore that produces all our microchips. Since it was the inexpensive 6500 family of microprocessors developed at MOS Technology that brought you the first truly affordable microcomputers—culminating in the VIC 20 and Commodore 64—and made Commodore one of the outstanding growth companies in the United States and around the world, it seems appropriate that we should take a look in this anniversary issue at just what they do over there in Norristown. Besides which, the process of chip making is pretty interesting in and of itself.

I have to admit that in researching the article about microchips, I learned a whole lot. Our technical editor, Jim Gracely, who already knows all that hardware-type stuff—or almost, anyway—seemed to be getting a kick out of listening to my great "revelations", and dutifully read my final story to make

sure I hadn't said anything stupid. So if I've said anything stupid, you can blame him. Only don't tell him I said that.

I did all my philosophizing about the impending arrival of the year 1984 in *Power/Play* last month, so I won't go through it again. (It's hard to ignore the fact, nevertheless, that there it is, looming on the horizon.) What fascinates me, though, is how far computers have come since Orwell wrote that book and how our attitudes have changed toward them. In 1948, which is when *1984* appeared, we had the leviathan ENIAC. OK, it was primitive. The astounding thing is that its creators estimated that it would take only about *four* such "super calculators" to take care of all the computational needs of the whole U.S.A. And not many more to take care of the world. (No wonder Orwell was paranoid about computers.) Their naivete (or was it hubris?) makes you wonder, doesn't it? What assumptions are we operating under today that in thirty years or so will seem as silly as that one?

Commodore as a company has had an outstanding year. We in the publishing department have had an equally good one, thanks to the many readers who have taken the time to send us articles and letters, an unbeatable design team who revamped our whole "look" to make us (in my humble opinion) the most attractive computer magazine out there, and the people in Commodore's management who gave us the support we needed to

make the magazines more accurate, prettier and generally more useful to the crucial person at the other end—you, the Commodore computer user.

All of us here at the big C would like to wish all of you out there at the other end a holiday season full of joy and a new year that brings you peace and prosperity. See you in February. **C**



—Diane LeBold  
Editor



## Get the Best Picture From Your Monitor

To the Editor:

Although an attractive feature of the Commodore 64 computer is the ability to attach it directly to a television set, many business, educational, and scientific uses are better served with the purchase of a separate video monitor. The Commodore 64 is inherently capable of producing an excellent picture on such a monitor, but if my own experience is typical, many individuals are getting short-changed in this area. The major problem is that the cables sold for attaching monitors to the Commodore 64 can be wired in several different ways. They all produce a picture, but the disparity in picture quality is enormous.

In order to achieve optimal picture quality with a monochrome monitor (green, amber, or black/white), one must be at least superficially acquainted with the operation of the audio/video output socket. In addition to the audio signal, this output socket provides two types of video signals: one, called the *luminance* signal, provides brightness information while the other, termed the *video* signal, provides color information. A friend of mine who purchased a monitor cable for his Commodore 64 at a local computer store was given a *video* cable which, in spite of its misleading name, provides a rather fuzzy picture when used with a monochrome monitor. I purchased a cable at a second com-

puter store, and was given one in which the *video* and *luminance* signals were mixed. The result is a better picture than with a video cable alone, but an even sharper picture is obtained when one uses a *luminance* cable in which only the luminance signal is employed.

The situation is even more complicated when using a color monitor. The Commodore 1701 color monitor I purchased comes with a two-jack cable, which plugs into the video and audio sockets on the front of the monitor. The manual states that a better picture can be obtained by using the three sockets in the back (audio, luma, and chroma), but warns that the computer must have an eight-pin audio/video socket in order to attach the monitor in this way. I have found, however, that in spite of the fact that the audio/video socket on my Commodore 64 is a five-pin socket, it can be attached by an appropriate cable to the sockets on the back of the monitor. The result is an enormous improvement in picture quality. Many color combinations that were virtually unreadable when the monitor was attached through its video and audio sockets on the front now give me excellent picture quality. The secret is to wire the luminance signal (pin #1) to the luma socket on the back of the monitor, the video signal (pin #4) to the chroma socket on the back of the monitor, and the audio output signal (pin #3) to the audio socket on the back of the monitor. If you cannot find such a cable locally, they are relatively easy to

wire or have wired for you. If you make your own cable, the location of these three pins is given in the Commodore 64 user's guide (page 142). You should note, however, that the diagram in the manual is for the audio-video socket on the back of the computer, and that the pins on the cable plug will therefore be the mirror image.

Armed with the above information, one can attain excellent picture quality with the Commodore 64 using either a monochrome or color monitor. It is unfortunate that many stores, at least in our area, are not knowledgeable about these facts and even demonstrate floor models of the Commodore 64 improperly wired to a video monitor.

Lewis J. Kleinsmith  
Ann Arbor, Michigan

## Calculating Folds

To the Editor:

I realize that Jim Gracely's program on page 58 of the June/July issue of Commodore was simply for illustration of the Stop-Print method of debugging. However, just in case someone is actually looking for a program to calculate new length after a number of folds, the following is much simpler and more direct and would probably never require debugging:

```
10 INPUT "LENGTH IN FEET"; A
20 INPUT "NUMBER OF FOLDS"; B
30 L=A/2↑B
```





## REAL-WORLD INTERFACES FOR COMPUTERS

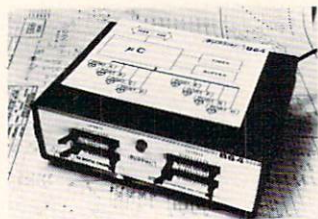

### ANALOG AND DIGITAL INPUT/OUTPUT

The BUSSter line of analog and digital products was designed to collect data and to output signals to laboratory and industrial equipment in conjunction with a microcomputer system. These powerful self-contained modules reduce a computer's workload by providing read or write operations to external devices. They are controlled as slave interfaces to real-world physical applications. Control is over an IEEE-488 (GPIB) bus or RS-232 port. The internal buffer and timer provide flexibility by allowing the BUSSter to collect data while the host computer is busy with other tasks. All units have a timer which operates from .01 seconds to 46 hours.

- **BUSSter** — 64 channel digital input module to read 64 digital signals. Built-in buffer . . . . . \$495.00
  - **BUSSter B64** — 64 channel digital output module to send 64 digital signals . . . \$495.00
  - **BUSSter C64** — 64 channel digital input/output module to read 32 and write 32 digital signals. Built-in buffer . . . . . \$495.00
  - **BUSSter D16** — 16 channel analog input module to read up to 16 analog signals with 8 bit resolution (1/4%). Built-in buffer . . . \$495.00
  - **BUSSter D32** — 32 channel version of the D16. . . . . \$595.00
  - **BUSSter E4** — 4 channel analog output module to send 4 analog signals with 12 bit resolution (0.6%) . . . . . \$495.00
  - **BUSSter E8** — 8 channel version of the E4 . . . . . \$595.00
  - **BUSSter E16** — 16 channel version of the E4 . . . . . \$695.00
- Add the suffix -G for IEEE-488 (GPIB) or -R for RS-232.

All prices are USA only. Prices and specifications subject to change without notice.

**30 DAY TRIAL** — Purchase a BUSSter product, use it and if you are not completely satisfied, return it within 30 days and receive a full refund.

US Dollars Quoted—\$10 Shipping & Handling  
MASTERCARD / VISA



**Connecticut microComputer, Inc.**  
**INSTRUMENT DIVISION**

36 Del Mar Drive • Brookfield, Ct. 06804  
(203) 775-4595 TWX: 710-456-0052

# letters

## 40 PRINT "NEW LENGTH IS" L "FEET."

Even though I am an absolute beginner at computing, I enjoy your magazine very much.

Ralph G. Smith  
Phoenix, Arizona

## Aligning Decimals

To the Editor,

I would like to suggest a fairly easy approach to the problem of aligning the decimal points in a column of numbers as an alternative to the more complete treatment in "Dollars and Cents Make Sense" on page 90 of Volume 4, Number 3.

The demonstration program below precedes the number with a sufficient number of spaces to align the decimal points of all but E-format numbers. The guts of this routine are lines 20 and 25, which may be structured as a subroutine for more general use. This routine will not add zeros to fill out places beyond the decimal point, nor will it include a decimal point for an integer.

```
10 INPUT Z
15 PRINT TAB(10); "(CU) ";
20 FOR E=6TO0STEP-1: IF
  ABS(Z)<INT(10^E) THEN
  PRINT " ";:NEXT
25 IF Z<>0 THEN PRINT"";
30 PRINT Z
40 GOTO 10
```

Alvin H. Bachman  
Spring Valley, New York

## More on Enhanced Remarks

To the Editor:

Your article on enhanced remarks (May, 1983) sounded like a great idea. I was curious to see if the routine could be adjusted to run on the Commodore 64. After looking the program over I found that there were only a few lines that had to be adjusted.

The first thing that must be changed is the start of BASIC. BASIC on the Commodore 64 starts at memory location 2048. Line 50000 should read:

```
FORX=2048 TO 50000
```

Next, the code to the printer to print expanded characters has to be changed. The code for the Commodore 64 is CHR\$(14). Line 50030 should read:

```
IF PEEK(X)=143 AND
PEEK(X+1)=255 THEN
POKE X+1,14
```

This slightly adjusted routine will give program listings enhanced remarks and improved readability on the Commodore 64. One more note. On printers with a special listing mode for cursor control symbols, you may not specify this mode along with enhanced remarks.

James P. Richmond  
Medford, Massachusetts



## Happy 25th Birthday, Commodore!

### The Commodore Quarter Century: From Retail Shop to Global Giant by Leslie Wood

In just 25 years a small typewriter sales and repair shop tucked away in downtown Toronto, Canada, has been transformed into one of the hottest personal computer companies in the world—Commodore International Limited.

Shipping more units world-wide than any other computer company, Commodore has grown from sales of \$46 million in 1977 to over \$680 million in fiscal 1983 (year ended June 30). And much of that success is due to the entrepreneurial instincts of Commodore's founder and present vice-chairman, Jack Tramiel.

The Polish-born Tramiel survived Nazi concentration camps to immigrate to North America and, in 1958, open his own typewriter shop in Toronto. Tramiel has always had a gift for anticipating future home and business electronic needs—and the ability to move quickly to fill them. Commodore's progress is a testimonial to that trait.

Over the past quarter-century Tramiel has led Commodore on a heady ride through adding machines, electronic calculators, digital watches and the introduction of the personal computer age. Together with his skilled management team around the world, he is still considering: what's next? Commodore, in fact, is widely acknowledged as a company that puts into action a smart but simple rule—hold onto the old for as long as it is good and change to the new the moment it becomes better.

During those early years, Commodore grew from typewriter repairs and sales to typewriter manufacturing, with the acquisition of a factory in Berlin, West Germany. Early in the 1960's Tramiel began selling and servicing a wide range of office equipment, and distributing nationally for an office furniture company.

In 1965 Commodore acquired the furniture manufacturer, and moved operations to what is now Commodore's present Canadian headquarters. Commodore still manufactures office furniture (mainly filing cabinets and desks, plus metal housings



for the CBM 8032 and SuperPET) at this plant in Scarborough, Ontario, and has expanded operations to three offices and two manufacturing plants in the Toronto vicinity.

Also in 1965 Tramiel met Canadian lawyer and financier Irving Gould, who later became Commodore's chairman. These two formed the head of the team that built the Commodore we know today. One of the first things this team did was to sell Commodore's adding machine plant and find a company in Japan to make adding machines for Commodore to distribute. While in Japan, Tramiel got his first look at an electronic calculator, and he quickly deduced that this product would mean the death of the mechanical adding machine. With the Commodore philosophy that "if we are not our own competition, then someone else will be", Tramiel moved quickly and found manufacturers to produce electronic calculators under the Commodore name. Thus the company was right there in the market when it began to take off.

The company began manufacturing its own electronic calculators in 1969 using Texas Instruments chips. In fact, Commodore was the first company to bring out a hand-held calculator—the C108—an example of what has become a long history of Commodore "industry firsts" in marketing value, innovation and performance in new products. It is interesting to note that this product was sold at much the same price, through similar distribution



channels and to similar customers, as is the popular VIC 20 computer today.

Up to 1974 Commodore expanded its line of calculators from simple four-function machines to memory machines, scientific machines and keyboard programmable models. At that time Commodore was largely dependent on third parties for the chips and displays that went into the products it was making.

Then in 1975 Texas Instruments decided to go into business against its own customers by manufacturing calculators. At the same time, chip prices dropped from \$12 to \$1 and Commodore was caught with a big inventory of chips and calculators while market prices plunged. It was this incident that led to Tramiel's decision that Commodore would be a company that controlled its own destiny, and not be at the mercy of other manufacturers.

Shortly thereafter, in 1976, Commodore purchased MOS Technology, Inc., one of its semiconductor chip suppliers, and worked its way toward becoming vertically integrated. This vertical integration now allows Commodore to supply its own needs and gives the company significant lead time in new product development. This means manufacturing cost advantages, which in turn translates into price/performance benefits for customers.

The acquisition of MOS Technology was followed in the next 18 months by two further key investments: the purchase of Frontier, a Los Angeles manufacturer producing chips that were complementary to those produced by MOS, and the acquisition of Dallas-based Micro Display Systems Inc., a manufacturer of liquid crystal displays. As a result of these acquisitions Commodore had in-house expertise and production in more key technologies than most electronics companies several times its size.

Also in 1976, Commodore reorganized its corporate structure as Commodore International Ltd. and moved its financial headquarters to the Bahamas and its operations headquarters to Wayne, Pennsylvania (it has since re-established in West Chester, Pennsylvania).

The next year was the watershed for Commodore when in 1977—still anticipating the future in true

Commodore style—the company introduced its first personal computer: the PET.

The PET (Personal Electronic Transactor) uses the MOS-designed 6502 microprocessor, which is also used by some of Commodore's competition. It was this original machine, launched at the Hanover Fair in Germany and the Consumer Electronics Show in the U.S.A., that helped give birth to the personal computer market of today.

The PET sparked another period of rapid growth, which is still underway today. It was marketed worldwide and really took hold in the European market because of the widespread, loyal dealer network Commodore had developed in its distribution of calculators. Commodore dominates the personal computer market in Europe today with more than 50 percent of the market in many countries. In fiscal 1983 (year ended June 30) European sales reached \$155.6 million (U.S. dollars), almost 23 percent of Commodore's total sales.

After the PET 4000 and later the CBM 8000 series micros, the next major product from Commodore was the very popular VIC 20. The prototype of the VIC 20 was previewed at the National Computer Convention in Chicago in 1980, and it was first launched in the Seibu Department Store in Tokyo, Japan because, as Jack Tramiel said about the threat of competition from Japan, "the Japanese are coming, therefore we must become the Japanese."

Commodore sold 800,000 VIC 20s world-wide in 1982, reached the one million mark early in 1983, and are now shipping VICs at the rate of 100,000 units per month.

Commodore didn't stop with that success either, but continued research and development and in August, 1982, shipped the first Commodore 64. By the end of that year, aided by the single biggest advertising campaign in Commodore's history, the 64 had already passed the Apple II in monthly unit sales. And by March, 1983, the 64 was being shipped at the rate of 25,000 machines a month.

Both the VIC 20 and the Commodore 64 are sold through mass merchandise retail outlets as well as computer dealers and selected electronics stores—a successful marketing technique that has since been



emulated by other companies.

Commodore has now become the largest unit seller of microcomputers in the world. And, according to a Dataquest study published in *Electronic News* recently, Commodore is number one in computers priced under \$1,000 with an estimated 43% dollar share in the U.S. Maybe this is one reason why the *Commodore 64 Programmer's Reference Guide* is currently the top-selling computer book in the U.S.

In addition to the obvious success the company has achieved in the home market, the Commodore name is familiar in both the business and education markets for personal computers. Commodore is one of the leaders in small business computers with its SuperPET and CBM lines, and the 64 is also being used for a number of functions in small business.

The education market is another area in which Commodore is a front runner. In Canada, for instance, Commodore holds about 65 percent of the national market for computers in education. Penetration is also significant in U.S., British and European schools and universities.

Commodore has become an international company, with manufacturing facilities in Japan, Hong Kong, West Germany, the U.K., Pennsylvania and California in the United States and Scarborough, a city within metropolitan Toronto. In fiscal 1983 world-wide sales increased 44.7 percent over 1982's \$304.5 million to reach over \$680 million. By the end of fiscal 1984, Commodore will be a billion-dollar-plus company.

Wall Street financial analysts who follow Commodore (shares have been traded on the New York Stock Exchange for three years, and were available on the American Exchange several years prior to that) state that much of the company's success is due to its flexibility and willingness to adapt quickly to—and even initiate—changes in technology and in the marketplace. Jack Tramiel puts it more simply: "The minute you're through changing, you're through."

Commodore is celebrating its 25th year with an international extravaganza being held in Toronto early in December. The "World of Commodore" show

is the first truly international computer show to be orchestrated by a single microcomputer company.

The first all-Commodore show to be held in North America will feature 65,000 square feet of exhibits by suppliers of Commodore computers, software, peripherals and accessories, and by Commodore users clubs, special interest groups and microcomputer and business publications. Exhibitors are coming from several countries, including Canada, Turkey, the United Kingdom, Sweden, France and the U.S.A. to participate. Commodore operations from around the world will also be represented. In addition, a series of seminars conducted by some of Canada's best-known experts in the field will take the mystery out of micros for novices, and give valuable information to more experienced users.

A 10,000 square-foot hall will hold a major exhibit outlining Commodore's 25 years of history, its present hardware and software and the future of the company and its products. All who attend will see that the next 25 years will be as exciting as were the first 25. In fact, looking at the history of Commodore at the close of its first quarter century, it is easy to see that the company has consistently been a leader in recognizing change and leading the electronics industry into the changes. But, more than studying history, Commodore is a company that creates the history. Just watch. C



SEE US AT

**world of  
commodore**

INTERNATIONAL CENTRE, TORONTO  
DEC. 8-11, 1983

### ***Easy Script 64, Commodore's Under-\$50 Word Processor, Now Available at Your Dealer.***

Commodore Software has announced the immediate availability of *Easy Script 64*, for retail sale. *Easy Script 64* is a full-featured word processor for the Commodore 64 and SX-64 (portable) color computers.



"This is the first time a word processor with this much power has been offered at such an affordable price," said Sig Hartmann, president of Commodore Software. "We want everyone to be able to afford a computer system and the most important software that goes with it—by important software, we include word processing at the top of the list."

Hartmann said *Easy Script 64* rivals the best word processing programs in home computing and includes features found only in business and professional systems, such as the ability to interface with a spelling checker (Commodore's *Easy Spell 64*), and transfer words, phrases and blocks from one section of text to another.

Features include:

- Change display colors
- Global/local "hunt and find"
- Global/local "search and replace"
- Goto line number
- Insert/delete characters, lines, blocks, sentences
- Optional sound effect prompts
- Print up to 240 characters per line
- Special function key editing
- Superscripts and subscripts
- Transfer words and phrases
- Vertical tabs as well as horizontal tabs
- View/Scroll 764 lines and 130 columns

In addition, a special "form letter" command lets the user create "personalized" salutations and body copy from a separate file by simply storing the information—usually names and addresses—in the file. A simple command tells *Easy Script 64* to insert the information in the form letter.

*Easy Script 64* users can also add a spelling dictionary containing up to 30,000 words called *Easy Spell 64*. This companion software product points out possible misspellings by highlighting questionable words. In addition to the spelling checker's built-in 20,000 word vocabulary, *Easy Spell 64* lets the user enter up to 10,000 additional words—such as technical jargon or words the user commonly misspells.

## Commodore Donates Computer Systems to Education Departments in Four States

As part of its CREWS (Commodore Resources in Education With States) grant program, Commodore recently donated a total of 120 computer systems to the State Departments of Education in four states: California, New York, Pennsylvania and Texas. The systems include computers, data storage units, printers, modems, and educational software.

The computer systems will be distributed by the State Departments of Education to educational support centers where they will be used for in-service teacher training and for evaluation of instructional software. The donated units will allow states to provide teachers with hands-on training.

Commodore dealers in the area of each training center have agreed to provide support for the donated units, and training for the program coordinators. Coordinators will, in turn, instruct the states' teachers.

Commenting on the importance of manufacturer and dealer support for education, William F. Kernahan, Executive Vice President Educational Systems (a Commodore dealer) writes in *Commodore* magazine (May, 1983), "The very real danger is that the microcomputer, a device that holds unlimited promise for education, could easily slide into either misuse or non-use simply because of lack of adequate support for the person on the firing line—the teacher."

The New York State Education Department's Commissioner of Education, Gordon M. Ambach, stated, "It (Commodore's grant program) will enable public and private agencies to co-operate in making the wisest use of available resources to resolve the overwhelming needs for teacher in-service training, while keeping in mind the complex dimensions of equitable access and delivery of training."

"Commodore through its grant programs is helping to give educators the up-to-date, technological training and support they need," said David Rosenwald, Commodore's Director of Education Sales. "It's part of an all encompassing effort by Commodore to further enhance its position in



schools. This effort includes a dedicated educational sales force, grants to State Departments of Education, and increased availability of quality software."

In addition to the CREWS grant program Commodore also offers a Matching Grant Program for Education. For more details on these and other Commodore support programs for education, write to Pat Walkington, Education Department, Commodore, 1200 Wilson Drive, West Chester, Pennsylvania 19380.

## Dr. Dan Kunz Named Director of Educational Software

Dr. Daniel W. Kunz, 36, formerly Program Manager for Commodore Educational Systems has been named to the position of Director of Educational Software for the company. The announcement was made by Sigmund H. Hartmann, President of the Software Division.

Mr. Hartmann stated, "Dan brings the needed mix of educational, managerial and marketing skills to the newly formed Software Division. We are pleased to have him head up this important activity."

Dr. Kunz will be responsible for software development and acquisition of home and school educational software and related products. An educator by training, Dr. Kunz said, "The key word in the educational marketplace will be *quality*. Parents and teachers are demanding high quality software that uses the full capability of the computer to enhance learning at home and in school. Commodore intends to meet this demand."

Dr. Kunz has been a public school teacher, a college professor and a consultant to major educational foundations and agencies. In addition, he was a National Policy Fellow in Education at the United States Department of Education. Prior to his employment at Commodore he served as Director of Curriculum Planning and Inservice for the New Jersey State Department of Education where he also coordinated activities of the Teacher Corps, Teacher Center and National Council of States on Inservice Education.

C

VIC 20™  
COMMODORE 64™

# Still the Best!

Rated **THE BEST** educational program for the VIC 20™ by **Creative Computing** magazine.

**Commodore 64 version:** "This is the best typing tutor we have seen yet; it can get your children touch typing in short order and bring an old hand up to speed. Includes excellent training modules and an arcade type mode to liven things up and put some pressure on; ★★★★★" **INFO-64**  
Our customers continue to tell us of their success. . . .

"... delighted with my son's progress . . . he is the only one in his second grade class who touch types at the computer."

(58 year old man writes) . . . "great, excellent. To me a source of great learning . . . I just can't express how much I have enjoyed it!"

In daily use by schools across the USA.

"Computer aided instruction at its best" **Commander** magazine

## TYPING TUTOR + WORD INVADERS

The proven way to learn touch typing.

COMMODORE 64 Tape \$21.95

COMMODORE 64 Disk \$24.95

VIC 20 (unexpanded) Tape \$21.95

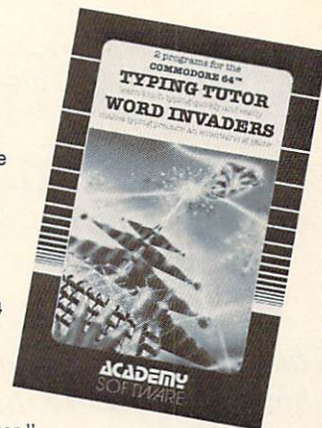

# NEW!

## IFR (FLIGHT SIMULATOR)

CARTRIDGE  
FOR THE VIC 20

**\$39.95**  
JOYSTICK REQUIRED



Put yourself in the pilot's seat! A very challenging realistic simulation of instrument flying in a light plane. Take off, navigate over difficult terrain, and land at one of the 4 airports. Artificial horizon, ILS, and other working instruments on screen. Full aircraft features. Realistic aircraft performance — stalls/spins, etc. Transport yourself to a real-time adventure in the sky. Flight tested by professional pilots and judged "terrific!"



Shipping and handling \$1.00 per order. CA residents add 6% tax.



# ACADEMY SOFTWARE

P.O. Box 6277, San Rafael, CA 94903 (415) 499-0850

Programmers: Write to our New Program Manager concerning any exceptional VIC 20™ or Commodore 64™ game or other program you have developed.



# Spread Sheet Programs: Expensive Gimmicks or Management Tools?

by Donald E. Hassler  
Fidelity Management Systems Phoenix, Arizona

*This is the third in a series of articles about Commodore microcomputers and business. These articles are designed to tell business owners just like me how to get the most out of that devilish device you purchased to make your daily business activities more productive.*

I have been using a Commodore 8032 for almost three years. During that time I have tried just about every type of program there is. I have also written some programs of my own. And I have modified others' programs.

There aren't many short cuts to getting the most out of your computer. You must get used to it yourself. The microcomputer is a *personal* device. So that is lesson number one: sit down in front of it, slide in a disk, and *get going!*

Now, what about spread sheets? I have been using *VisiCalc* for many months. It is simple, fast and powerful. There are assuredly more things you can do with it than you can possibly imagine. So load up your own favorite spread sheet and let's learn a few tricks.

If your business depends on sales or production of any kind, that's your first program. Lay out a complete sheet showing employee names, quotas or objectives, actual performance and percentages. Do it for each month and for year-to-date (YTD). This may seem a simple start but it works. It also gives you a regular report that your clerk or bookkeeper can do for you. But it's easy, gets you used to the system and offers regular information to your employees. (Lesson number two is that most of the initiative for new reports that you want to try will have to come from you.)

Now let's get more complicated. One of the most important uses for spread sheets is budgeting and forecasting. You are probably doing it already, but on paper. Well, throw away the pencils and erasers. Here's the easy way. Once you get all your accounts

or headings on the sheet you never have to do it again. And if you're not sure about the exact setup, buy one of the excellent books which show sample *VisiCalc* (or other) overlays.

Start with the sales budget and the expense forecast. Put all your major headings on the sheet and then fill in the columns with numbers. You can do it for the month and for YTD and have all that come out on standard 8½-inch wide paper. Or if you want a really big sheet, run 132 columns and condense your printer output.

Here are a few tips for setup:

- You'll find that numbers are easier to read if rounded off to even dollars, so use the "/FI" function (integer format)
- Remember that the columns can be varied in width, so experiment with proper widths to get everything you want on one sheet.
- Don't forget to show percentages or dollars over (under) budget. All this figuring will be done for you by the program.
- For speed of entry, set up your program so that it doesn't recalculate the whole sheet every time you add a character or a number (manual recalc). That's "/GRM" in *VisiCalc*.

Now you're ready to try something a little more complicated, but it's worth it. This routine, a "break even" analysis, will reveal more about your business than almost anything else. It also makes the best use of spread sheet systems because you can vary all the figures on the sheet with only one master entry.

Start by setting up a column of labels for all your sales/revenue functions, cost of goods functions and a complete list of all your expense categories. Remember to add expenses in two types, fixed and variable. Fixed are those which are always the same: rent, various lease payments, insurance, etc. Variable are those that change with some other function: sales commissions, advertising, p/r overhead, etc.

Now fill in the column of expense items with dollar values for the fixed items and a percentage formula for the variable ones. The formula will be a percentage of either sales or costs (or maybe even



payroll in the case of p/r overhead). Now find the position in your column for total sales/revenue. That number is the key to your analysis. Everytime you change it, all the variable items will change by their proportionate percentage. When sales rise, commissions, advertising and promo expense all go up, for instance. Fixed items like rent stay the same whatever your revenue (unless you're on a percentage rent, in which case figure it in.)

You want to find a spot near the top of your sheet and have the total net sales figure copied there. Now you can change it easily and watch how it effects the bottom line (net profit). After locating the break even sales figure you can play with the sheet even

more. Try varying the cost of sales items. Or try changes in your gross margin percentages.

Total familiarity with this approach is a must for any business manager today who wants the most out of his Commodore computer system. So this is the biggest lesson for this article: find ways related to your business where you can use the power of your Commodore. Changing long and complicated rows and columns of figures instantly is one of the most effective ways to use microcomputer power.

See your local Commodore dealer for recommendations on the best spread sheet program for you.

C

# A Case of Convenience

Now that you can't live without your personal computer, why leave it behind? With TravelMaster™ your Commodore™ goes wherever you do.

The foam interiors of TravelMaster cases are custom cut to cradle your Commodore 64™ or VIC 20™. The rugged, double-wall, molded exterior protects each delicate piece.

Call your dealer today, he'll tell you how to travel with your computer safely, in style — and for a lot less than you might expect. What could be more convenient?

Commodore 64 and VIC 20 are trademarks of Commodore Electronics Ltd.

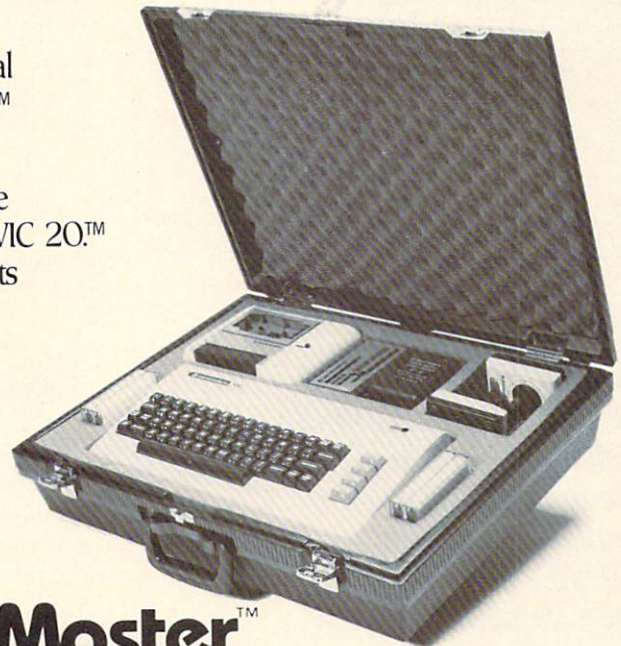

## TravelMaster™

Manufactured by Southern Case, Inc.

TravelMaster Division • P.O. Box 28147 • Raleigh, NC 27611 • (919) 821-0877



# Lincoln College Commodore Computer Camp

by Tom Zurkammer



Keith Peterson instructs his students in advanced BASIC and assembly language.

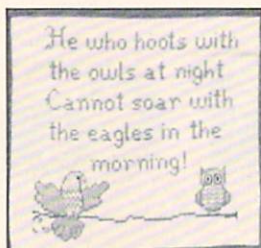

Computer hackers, take warning!

Jim Butterfield reflects on the answer to a question in one of his sessions covering the Commodore 64.



Fifteen-year-old Jon Sadler, one of the camp's youngest participants, came to the camp to learn assembly language.



Dick Immers, the "Disk Doctor", teaching file handling and advanced disk operation.

*Commodore users found more in the Central Illinois prairie than corn and soybeans this summer. They also discovered a small slice of computer heaven thanks to Lincoln College's first Commodore Computer Camp.*

Lincoln College, a small, private, two-year college located in Lincoln, Illinois, hosted some 50 "campers" as well as Commodore computer experts for a week-long workshop last summer. Participants traveled great distances—some from as far away as both coasts, Texas and Canada—to rub elbows, swap notes, attend classes and lectures and bask in the knowl-

edge of such noted Commodore "wizards" as Jim Butterfield, Dick Immers, Walt Sadler, Keith Peterson, and Len Lindsay.

The adult campers displayed varying degrees of computer knowledge. Most participants, however, were highly computer literate. They use their computers in small businesses, in corporations, in teaching and as hobbyists.



---

Jim Strasma, assistant professor of computer science at the College and editor of the *Midnite/Paper*, and I conceived the idea of the camp. We wanted to bring together several well-known Commodore computer experts at one time in one place and introduce persons from across the country to Central Illinois and Lincoln College, because we have a strong commitment to building a top-notch computer program at our college.

Income derived from the workshop will help expand the college's existing Commodore equipment and, more importantly, provide funds for student scholarships. The college's three year-old computer department recently bought 16 SuperPETs to enable the offering of different computer languages to about 150 students per semester on the main campus. Other classes are conducted at the college's branch locations.

The presence of Jim Butterfield, whom Strasma calls "the most famous PET owner," proved to be the trigger needed to draw attendance at the camp. A well-known technical writer from Toronto, Ontario, Butterfield's appeal is in his ability to take something complex and make it understandable.

"They tell us he's the man who keeps Commodore honest. He's not on their payroll and he tells the truth, good or bad," commented camp participant Betty Clay, a math and science teacher in the Arlington (Texas) Public Schools. "I came to this camp because of

Butterfield. He knows how to teach. I expected to understand him and I did."

Butterfield's classes focusing on assembly language and sound and graphics on the Commodore 64 were among the best attended camp sessions. Participants eagerly absorbed information about assembly language, primarily to be able to write better game programs using machine language instead of BASIC. Butterfield's sound and graphics sessions for beginners taught control of those functions using BASIC.

Butterfield quickly refutes the conception that computer people isolate themselves from the rest of society in an effort to keep their knowledge to themselves.

"The idea of a mad scientist sitting in a corner with a computer does not in any way resemble reality. Computer people are very social. They like to talk about their computers, brag and share their knowledge," he said. These feelings might be well evidenced by the "PUGs" around the country (Pet User Groups).

Dick Immers, known in Commodore circles as the "Disk Doctor" because of his doctoral research on computer disks, was another of the featured Commodore experts. Disk file handling and advanced disk operation sessions taught by Immers also proved popular. He helped participants refine their file handling skills, which are essential for successful programming. The advanced sessions explored the disk

drive using machine language.

Walt Sadler, a professor of mathematics at the University of Wisconsin, Waukesha, who specializes in teaching computer use to young children, conducted sessions for beginners and persons interested in knowing more about computer applications for schools.

Keith Peterson, a former member of Commodore's software development and support group, conducted sessions in advanced BASIC and advanced assembly languages. Peterson used an assembler to demonstrate machine language programming. He also presented information about Commodore's "B" machine and CP/M.

Peterson noted that Commodore supports opportunities for users to share knowledge. "The millions of people using Commodore will have a lot more knowledge than the computers' designers," he said.

An introduction to COMAL was demonstrated by Len Lindsay in an evening presentation. COMAL is a computer language that combines the best parts of Pascal and BASIC. Lindsay had with him one of the first copies of COMAL for the 64. It promises to be a fine language, especially for schools.

Debra Landre, a computer instructor at Lincoln College's Bloomington campus, taught intermediate BASIC sessions. She brought participants, who already had at least one BASIC course, to a more skillful level of programming. She also provided help with





COW BAY COMPUTING  
has a lot to offer you and your  
PET/CBM/COMMODORE 64

---

#### SOFTWARE FOR THE CLASSROOM

- o The Pet Professor      \$499.00
- o With Management System  
                                    \$649.00

A total arithmetic package with step-by-step instruction. 77 programs in addition, subtraction, multiplication and division on cassettes or disks. Ask for a sample.

Specify disk drive and computer configuration.

---

#### WORKBOOKS FOR COMPUTER LITERACY

- o Feed Me, I'm Your PET      \$5.95
- o Looking Good With Your PET      \$5.95
- o Teacher's PET      \$5.00

---

#### STUDENT SCHEDULING SYSTEM

- o Fast, accurate, easy-to-use and less expensive than current methods.
- o Uses a 8032 computer and 8050 disk drive
- o 90 Day Money Back Guarantee to prove that it can be done.

COW BAY COMPUTING  
P.O.Box 515  
Manhasset, N.Y. 11030  
(516) 365-4423

# education

Interestingly, a real sense of how to assemble programs with more style. community surfaced at the Lincoln College camp.

"We are a group working together for our mutual benefit. You really don't ever become an 'expert,' because you are constantly learning new concepts and expanding your knowledge outward," Peterson remarked. "You know you don't know everything, but you know how to figure things out."

One of the youngest camp participants, 15 year-old Jon Sadler, son of Walt Sadler, came to Lincoln College's camp to learn assembly language. The young Sadler began working with computers when he was nine years old. Now he has several programming awards under his belt. He recently co-authored, with his father, a soon-to-be marketed program for teaching music.

"I consider the computer a challenge. I like to see if I can do it. Often I don't get my homework done," he admitted.

Jon Sadler enjoys the label "computer nut." To be a computer nut, Jon says, "you need to know a computer language and be devoted to getting the program right or working to debug it and try again, but not abandon the program. You also have to be in the abstract stage of mind development in most cases."

J. Paton Dellow, Lincoln, Illinois, who reviews computer

software for Commodore and works as a supervisor of clinical services at a Central Illinois correctional facility, felt the camp was nothing short of "fabulous."

"There is a great deal of talent at the camp. I hope to capitalize on as much of it as possible," he said.

What surprised the camp organizers was the level of emotional and financial investment exhibited by camp participants.

"It turned out to be a very high plane," Strasma noted. "As one person commented, 'I came to eat, sleep, drink and breathe computers,' and that's what the majority of participants appeared to be doing. Even scheduled free time ended up being devoted to computers at the participants' choice. The camp won rave reviews."

Lincoln College staff are already planning next year's summer computer camp which will again feature Commodore experts. Enrollment will be limited because we want to start out small and be very personal. A complete listing of course offerings and times will be available in late November. Information about next year's camp can be obtained by writing to Tom Zurkammer, Dean of Academic Affairs, Lincoln College, Lincoln, IL 62656. **C**



# The Commuting Commodore

by Doris Dickenson

## *Our classroom 64 gets a "baby brother"*

Our fourth-grade classroom treasury got a real boost from an aluminum can drive last spring and by watching for the microcomputer sales we were able to purchase a VIC 20 as a second classroom computer. I made this choice because the hardware we already had and the programming the students had already learned on the 64 would be compatible with the new computer.

We set up a second computer corner in the back of the classroom and copied the manuals we were already using with the 64. Except for the color codes, our material applied just as well to the VIC 20. I checked the practice programs the students were using and coded the upper corner of each page 64 or VIC 20 or both, so students could tell readily which programs were appropriate for which computer.

I really fell in love with the VIC 20 myself. When I taught programming, with my monitor on display for the entire class to watch, the large type and clarity of image made my examples so much more visible!

But I still wasn't satisfied. I wanted to give the students even more of a personal tie to the new computer, because it would be staying in the class when they moved on at the end of the year and they had earned the money to purchase it. That's how the "commuting computer" idea came about.

We had our new computer, and a letter of explanation, available for viewing at our open house in the spring. It told the main requirement for bringing the computer home overnight or on weekends: signing the Parental Computer Agreement. A sample of this agreement follows this article.

The names of eligible students, those whose parents had signed the agreement, were drawn at random each Friday, which established the computer schedule for the following week. Students who had had a turn waited until all eligible students were chosen before they got a second turn. Any switching of nights between students selected for that week had

to be done among the parents. I did not want to be involved in it. This worked very satisfactorily when any family had a conflict with dates.

Using the original packing box as a carrying case, I included not only the regular user manual, but a simplified diagram of the hookup method, in case

## PARENTAL COMPUTER AGREEMENT

Room 12, Pine Crest School  
Sebastopol, California

I agree to be responsible for the Room 12 computer. I understand the following conditions for borrowing it:

1. No food or drink is to be used around it because it can be damaged permanently by anything in the keys.
2. The computer will be picked up at school and returned to school by private vehicle. It is not to be carried home or taken on a school bus.
3. The computer must be returned as scheduled on the following day, or after a weekend, to give the next student his turn.
4. Small children will use it *only* under adult supervision.
5. If the computer is returned in damaged condition, I agree to replace it.
6. Violation of conditions 2 or 3 will result in your student losing computer privileges for the remainder of the year.

Student \_\_\_\_\_

Parent Signature \_\_\_\_\_

Date \_\_\_\_\_



some family did not take time to read the manual carefully. I also included a copy of the simplified manual the students used at school along with some of the programs with which they were already familiar. That really made them stars at home. Because of a recent article I had read warning of the dangers of mixing polarity in some wiring, I included a triple plug and encouraged them to use it for the computer and monitor, just to reduce the chance of a problem.

Of course, our "commuting computer" was a huge success. It was the talk of the school among

parents as well as students. It was great P.R. for our entire computer program. And the computer seemed none the worse for its adventures. This year we plan to continue the same program. One thing will change, however. The commuting program will start much earlier in the year, and it will be part of the reward system as students move through the sequential programming lessons that we use. C

## TYPRO DATA MANAGER & WORD PROCESSOR

For COMMODORE 8032 Computer — 8050/4040 Dr.

### DATA MANAGER

Number of records is only limited by your disk capacity. Up to 50 fields per record. Maximum of 75 characters per field. User formatted. Screen editing. Sort and search feature. Pattern match search. Selective field printing and formatting. Form letter addressing. Mailing list and mailing label printing. Format for fanfold Rolodex and index card printing.

### WORD PROCESSOR

Screen editing. Automatic line length set. Add, move or delete text. Global edit. Page numbering and titling. Form letter addressing. File append for printing. Selective underlining.

**BOTH PROGRAMS (Disk) , ONLY \$89.00**

All software is fully supported for updates and revisions for up to six months after purchase.

Specify Computer model number and Disk model number.

### INPUT SYSTEMS, INC.

25101 S.W. 194 Ave. Homestead, FL 33031 (305) 245-3141

DEALER INQUIRIES INVITED.



### For the VIC-20:

**Banner Machine** Professional signs in minutes! Ideal for offices, retail stores, & home use too! Size up to paper width by any length. Several fonts. Also for 64. \$49.95 Tape or Disk (Specify computer equipment)

**Teletitler** Turn your Vic-20 into a television title generator. Bold letter titles scroll for video productions or continuous-loop message displays. \$14.95

**Caves of Windsor** A cave adventure game. The object is to restore wealth and happiness to the small village of Windsor. \$14.95

### For the Commodore 64:

**Space Raider** An amazing arcade simulation. Your mission is to destroy the enemy ships. \$19.95

**Super Roller** Challenging dice game. Sprite graphics and sound. Yahtzee-style rules of play. \$14.95

**Formulator** A formula scientific calculator designed for tasks which require repetitive arithmetic computations. You can save formulas and numeric expressions. \$39.95

## Burgers & Fries

Eat the Burgers and Fries but Avoid the Sodas for a Top Score

**\$14.95**

### Preschool Educational Programs

ABC Fun; 123 Fun; and Ginger the Cat with: Addition and Subtraction, Number Hunt, and Letter Hunt. All programs have bright color, music, and action. Each \$14.95

**Microbroker** Exciting, realistic and educational stock market simulation based on plausible financial events. \$34.95 Tape or Disk

**Sprite Editor** The easy way to create, copy, alter, and save up to 224 sprite shapes. \$24.95

**Cross Reference Generator for BASIC programs** Displays line numbers in which any word of BASIC vocabulary appears. Allows you to change variable name and ask for lines where it appears, and more. \$19.95

Catalog available. Dealer inquiries invited

PHONE ORDERS: (703) 491-6502

HOURS: 10 a.m. to 4 p.m. Mon.—Sat.

**Cardinal Software**



Distributed by  
Virginia Micro Systems  
13646 Jeff Davis Hwy  
Woodbridge, VA 22191

Commodore 64 and VIC-20 are registered trademarks of Commodore Electronics Ltd.



# Educational Programming: A Method

by M. W. Caprio

*If you're a teacher who writes programs, here are some helpful hints to speed things up.*

In a way, the advent of affordable personal computers on the education scene has created a new problem for classroom teachers. In fact the computer, purported to be a time saver, is often—quite to the contrary—a great consumer of teacher time. The problem revolves around software and is a kind of “software dilemma.”

With good programs a personal computer can be a powerful educational aid. Getting good programs is the crux of the problem. If the programs are to do what teachers want, they really ought to be written by teachers. But teachers are already busy teaching. Writing high quality programs takes time—it takes time away from the study, lesson planning, extracurricular activities, all the things that teachers already do. But teachers are trying to write programs, nevertheless.

Working under the time constraints of a demanding profession, they are often forced to omit the subtleties that would be desirable if included in their programs. A title page, sophisticated reinforcement, and student response analysis can make the difference between a valued professional tool and an amateur attempt at one.

Professional programmers include all of these niceties, and

more, in the commercially available products that they produce, but professional programmers are not teachers. Some may have once taught, but now the program—not necessarily the student—is their chief priority. A subtle difference, perhaps, but one that impacts heavily on the teaching value of commercially available software. These programs may sparkle but, too often, they force us (teachers) to a pedagogical compromise.

And so it happens that educators are thrust on the horns of the “Software Dilemma”. Will it be hastily written programs with that unwanted homemade touch, written with stolen time and reflecting the time constraints that hurried their composition? Or will it be a program with all the bells and whistles that the professional can provide but without an acceptable educational philosophy or effective teaching style? Neither is acceptable. Amateurish programs are inconsistent with professionalism in education, and pedagogically unsound programs may actually do more harm than good. Fortunately there is a solution.

To get good educational software we must do one of two things: either teach programmers to teach, or teach teachers to program. The latter is obviously the more realistic choice. As teachers, we must learn to write professional-quality programs that are commensurate with our professional status as educators. And we

must learn to write quickly and efficiently so that our other responsibilities will not suffer disproportionately to the benefits to be gained by programming. After all, it has to be worth the time we spend on it. The objective then is to get to the point where programming is time-efficient, where we rely less on professional programmers and where we improve the quality of our programs. There is a programming method that makes it possible for anyone with even a rudimentary knowledge of BASIC to achieve this goal.

Teachers can most quickly enhance the efficiency and quality of their programming by adopting the logical approach to programming that many professionals use. Begin by writing your programs in a modular format. A modular program is a collection of subroutines that are called by the main part of the program to perform the tasks that need doing. In essence, writing a program in subroutines is a way of breaking a big job down into its smaller, more manageable components. Teachers are especially good at seeing what those components must be because in much of our teaching we do exactly that. We teach subject matter to our students in manageable “subroutines”.

But, you say, how can this improve efficiency? Wouldn't the modular program need to be as long or longer than the linear version of the same program? Valid



# BUFF QUIZ!

For your Commodore 64™

Who was the first U.S. President to be born in a hospital? What college did Batman attend? How many baseball fans watched The Mighty Casey strikeout? What was the maiden name of James Bond's wife?

If you think you know the answers to these and other entertaining and challenging questions, or if you are a trivia buff, history buff, or just a plain old buff, you should have BUFF QUIZ!

BUFF QUIZ is a series of quiz games developed by educators and tested by kids and young adults. It keeps a permanent record of the top ten highest scores, providing an achievable objective for each player.

AVAILABLE ON DISK ONLY, you may order:

- BUFF QUIZ 1     \$20
- BUFF QUIZ 2     \$20
- BUFF QUIZ 3     \$20

Order all three and pay only \$50.

Send check or money order to:

R & D Software Unlimited  
Department A  
University Station  
P. O. Box 2574  
Thibodaux, LA 70310

Please add \$2 shipping and handling to your order. Allow 2 to 4 weeks for delivery. Faster delivery if payment is made by money order.

EDUCATIONAL SOFTWARE DEVELOPED BY EDUCATORS!  
Commodore 64 is a trademark of Commodore Business Machines, Ltd.

## education

questions. What makes this work for programming efficiency is something I haven't said yet. That is, *keep records*. Every time you develop a new subroutine, or find one you can use in a magazine or borrow one from another program, you must write it down. (I keep mine in a loose-leaf binder so they can be kept in alphabetical order as new ones are added.) By the time you've developed two or three programs you will have quite a collection of subroutines.

These subroutines might include your title page, reinforcement for student answers, sound, computation of the student's score and many others. They are all routines that can be used in more than just one program. What is most important is that they will all reflect your own teaching style and will correlate nicely with the way you do things in the classroom. They will use your language, your humor and will fall safely under the umbrella of your educational philosophy. They will precisely reinforce what is being done in your classroom: no more, no less.

Before long, writing a new program will mean writing the main program (it will bristle with GOSUB statements) and modifying the subroutines to fit the task at hand. You will be able to make most modifications as you type them in from your notebook. It will be unnecessary to reinvent the wheel each time. Drawing on your subroutine library reduces duplication of effort to near zero.

Shortly after beginning this method I found that the quality of

my programs began to increase dramatically while, at the same time, my writing got faster. The quality improves, I think, because after becoming familiar with a subroutine by using it a few times, I begin to see ways of refining it that may not have been obvious to me the first time through. Then too, student suggestions have been incorporated from time to time. Improvements continually accumulate in my loose-leaf book. Over the years I've polished and repolished my subroutines until they've become real gems. This is, clearly, not the tack to take if you are only planning to write one or two programs. Its rewards are not immediate but accrue over a semester or two.

Like the ditto machine, overhead projector and pocket calculator, the personal computer has become part of the teaching technology—a tool of the trade. Whether or not it will be integrated into our professional lives is no longer an issue. The real question now is how to best streamline its assimilation.

To get you started with modular programming I would be happy to send you copies of a few of my treasured subroutines for the PET and Commodore 64. They are simple but effective. Write to me at Box 180, Stony Brook, New York, 11790 and send a self-addressed, stamped, business envelope.

While you are waiting for the mail to bring your subroutines, you may want to try the sample program. It took ninety minutes to write using routines from my

## A Giant Step for the computerist

### THE PROMQUEEN

Opens up the world of modern electronics. Now — a complete microdevelopment system in a cartridge using the Commodore VIC-20. You get HEXKIT 1.0 for general purpose 8 bit microprocessor software development, a 4K ROM emulator for testing program in circuits under development plus an EPROM programmer for making hard copy of programs.

All-in-one cartridge with 100 page tutorial manual.

**\$199<sup>00</sup>**

Arbutus Total Soft, Inc., 4202 Meridian, Suite 214, Bellingham, WA 98226. Phone 800-426-1253, in Washington 206-733-0404  
Distributed in Canada by IBC/Distribution Canada, 4047 Cambie St. Vancouver, BC V5Z 2X9. Phone 604-879-7812

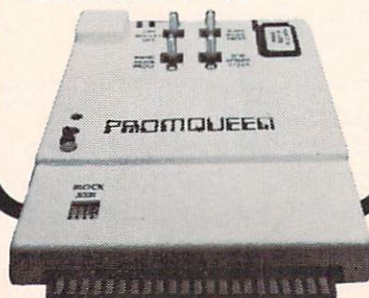



loose-leaf book and is included as an example of modular programming. The routines that you see are accessed by GOTO as well as GOSUB statements, whichever works better.

Each routine is identified by REM's but I'd still like to say a few words about two of them here. First, there is the Input Subroutine. It is used in place of the INPUT statement to prevent those accidental crashes so frustrating to new computer users—the ones that occur when they press the PET's return key at the wrong time. Since it gets the input in a string variable, it obviates the REDO FROM START error. Use it to help crash-proof your programs, or modify it to—in effect—disable any key(s) for input, with the exception of RUN/STOP.

The Character Search routine is the second. I use it to analyze student responses for the inclusion of a particular character. In this program it is looking for a dollar sign but it can be easily modified to search for commas, apostrophes or any character at all. In some of your programs you will want to alter it to check for a whole class of characters, like capital letters. Use the Character Search routine to elevate your program's interactive style and enhance its capability to provide feedback to students.

The sample program is useable and may even be useful as it stands. But, it wouldn't hurt to dress it up a bit with one or two subroutines of your own. A title page would be a nice embellishment and a page of instructions may help to make the program a

bit more user friendly—two easy subroutines. Other alterations might include modifying the subject matter itself.

How about making it into a drill for percent problems or an exercise for students to practice their number facts? It is a parent program that can easily give rise to a whole family of offspring. For example, I can modify the sample to do, let's say, addition facts in much less time than it took me to write the original version. Then, the hardest part—but not the only part—to create *Subtraction Facts* from *Addition Facts* will be changing the title page. The program family grows so easily and so quickly because the “new” programs are built of previously developed routines. That is, after all, the whole idea. **C**

## Subroutines

```
380 REM *** INPUT SUBROUTINE ***
390 Z$=""
400 GET A$:IF A$=""OR A$>CHR$(90) OR (A$=CHR$(20) AND LEN
    (Z$)<1) THEN 400
410 IF A$=CHR$(13) THEN 460
420 IF A$=CHR$(20) THEN Z$=LEFT$(Z$,LEN(Z$)-1):GOTO 450
430 IF A$<CHR$(32) THEN 400
440 Z$=Z$+A$
450 PRINT A$;:GOTO 400
460 RETURN
470 :
480 REM *** CHARACTER SEARCH ***
490 FOR I=1 TO LEN(R$)
500 B$=MID$(R$,I,1)
510 IF B$="$" THEN DS=1:GOTO 530
520 T$=T$+B$
530 NEXT I
```



```
540 R=VAL(T$):T$=""
550 RETURN
560 :
570 REM *** INST. ON ERRORS ***
580 REM THIS WILL BE MORE SOPHISTICATED FOR MORE COMPLEX
    EXERCISES.
590 PRINT "[DOWN] $";M1;"- [SPACE] $";M2;"= [SPACE] $";A
600 PRINT "[DOWN] YOU [SPACE] HAVE [SPACE] $";A;"LEFT."
610 RETURN
620 :
630 REM *** ENDING ROUTINE ***
640 PRINT "[CLEAR] YOU [SPACE] TRIED";N;"PROBLEM";
650 IF N>1 THEN PRINT "S";
660 PRINT ", [SPACE] "+N$+"."
670 PRINT "YOU [SPACE] GOT";C;"CORRECT."
680 PRINT "[DOWN] THAT 'S";INT(C/N*1000)/10;" [LEFT] %"
690 PRINT "[DOWN2] BYE."
700 END
```

## Sample Program2

```
100 REM *** A SAMPLE PROGRAM ***
110 :
120 PRINT "[CLEAR] WHAT [SPACE] IS [SPACE] YOUR [SPACE] FIRST
    [SPACE] NAME? [SPACE] ";
130 GOSUB 390:IF Z$=""THEN 130
140 N$=Z$
150 :
160 REM *** THE MAIN PROGRAM ***
170 N=N+1:M1=INT(20*RND(1)+11):M2=INT(9*RND(1)+1):A=M1-M2
    :DS=0
180 PRINT "[CLEAR]";N;" [LEFT] ."TAB(5) "IF [SPACE] YOU [SPACE]
    HAVE [SPACE] $";M1;" AND"
190 PRINT TAB(5) "YOU [SPACE] SPEND [SPACE] $";M2;" OF [SPACE]
    THEM,"
200 PRINT TAB(5) "HOW [SPACE] MUCH [SPACE] MONEY [SPACE] IS
    [SPACE] LEFT? [SPACE] ";
210 GOSUB 390:IF Z$=""THEN 210
220 R$=Z$:PRINT
230 GOSUB 490
240 IF R=A THEN 300
250 :
```



```

260 REM *** REINFORCEMENT ROUTINE ***
270 REM A MORE SOPHISTICATED ONE IS AVAILABLE FROM THE A
    UTHOR.
280 PRINT"NO.":GOSUB 590
290 GOTO 320
300 C=C+1:PRINT"[DOWN,RVS]VERY[SPACE]GOOD."
310 IF DS=0 THEN PRINT"[DOWN]...BUT[SPACE]YOU[SPACE]
    FORGOT[SPACE]THE[SPACE]DOLLAR[SPACE]SIGN."
320 PRINT"[DOWN3,SPACE5]PRESS[SPACE,RVS]C[RVOFF]ONTINUE
    [SPACE]OR[SPACE,RVS]E[RVOFF]ND."
330 GET C$:IF C$=""THEN 330
340 IF C$<>"E" AND C$<>"C" THEN 330
350 IF C$="C" THEN 170
360 GOTO 640
370 REM:

```



What does **COMMODORE**  
have that Apple,  
Radio Shack  
and IBM  
don't?

# backpack™

BATTERY BACKUP SYSTEM

For CBM™/PET® 2000, 4000, 8000, and 9000 series computers and CBM 4040/8050 dual disk drives. Installs within the cabinets of the computer and disk drive. Recharges continually from the machine's own power supply and automatically supplies 30 minutes (max.) of reserve power during outages. Also eliminates surges and spikes. User installable.

In Canada call: Van-Hoy Group (604) 542-1138 or (604) 545-0794  
In United Kingdom call: Wego Computers (0883) 49235

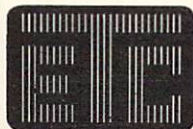

**ETCETERA OF CSC CORPORATION**  
APEX, NORTH CAROLINA, U.S.A.  
(919) 362-4200

SOLD ONLY BY INTELLIGENT COMPUTER DEALERS • DEALER INQUIRIES WELCOME



*Commodore's  
subsidiary,  
MOS Technology, Inc.,  
produces the chips  
that are the heart  
(and other such  
indispensable  
parts) of your  
microcomputer.  
Here's  
how they  
do it.*

IN THE

By Diane LeBold

If you've taken courses in integrated circuits most of this will be no news. But if you, like me, have been stumbling over words like "semiconductor" without understanding quite what they mean—or have been wondering exactly what this thing they call a "chip" really is—read on.

Those of you who have opened your computer's case know it's crawling inside with what looks like a bunch of mechanical caterpillars. Maybe somebody told you, as somebody told me, that these are your computer's "chips". Close, but not quite accurate. Although these caterpillars contain the chips, they themselves are just the protective packaging. They are called, in technical terms, "DIPs" (Dual In-Line Packages). When a chip is contained in a DIP (which sounds like something you'd find at a cocktail party rather than inside a computer), the whole thing is called a "device".

The parts you don't see—the quarter-inch silicon flakes inside



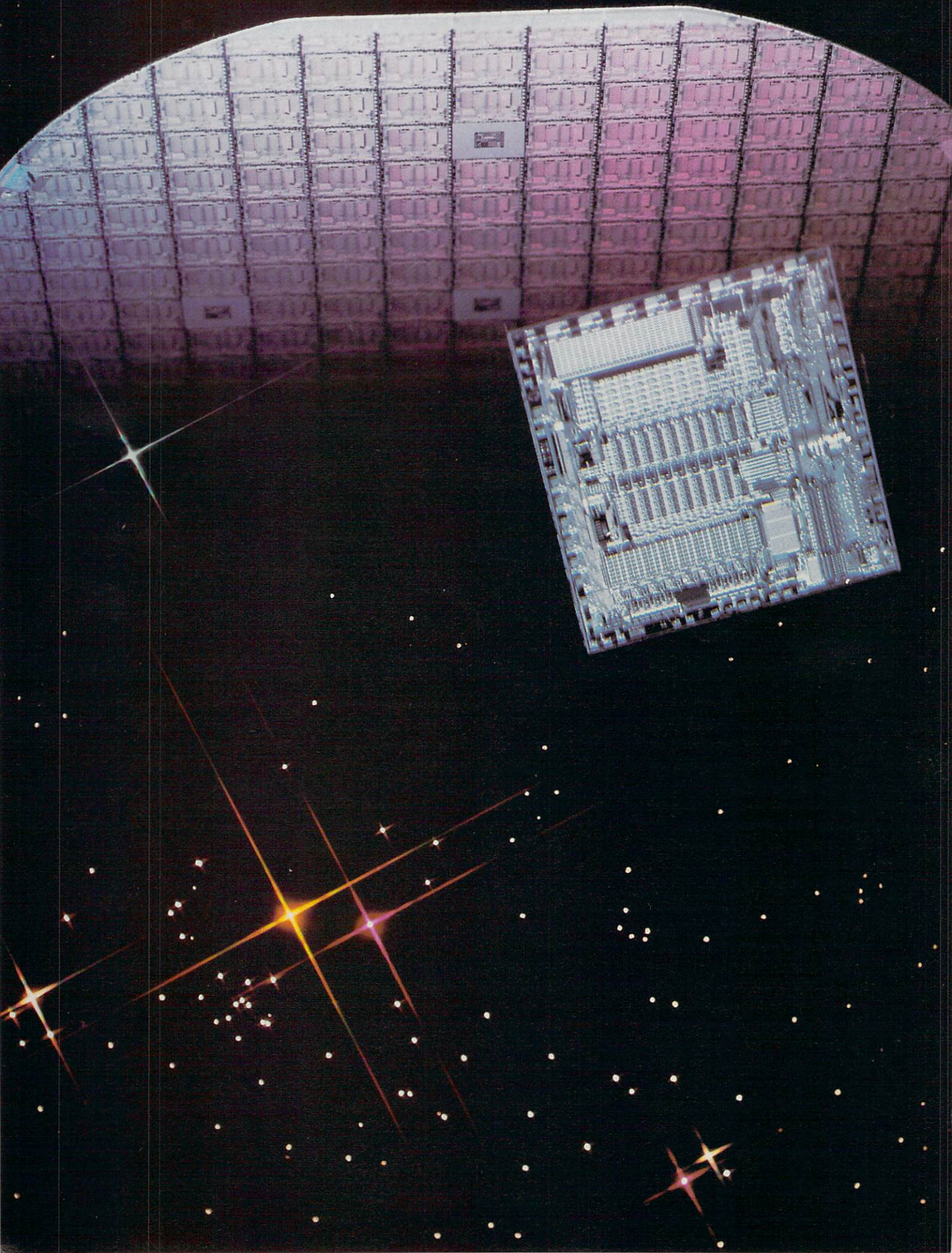



the DIPs—contain the actual electronic circuits that run your computer. There are several different kinds of circuits in your computer, each one with a different job. If a circuit carries out commands and does calculations, we call it a microprocessor. If it simply stores information it's a memory circuit. If it lights up the tiny dots on a monitor it's, of course, video. And if it controls speakers it's a circuit for sound.

The miracle (taken for granted now) is that these complex circuits, which thirty-five years ago would have taken up literally whole rooms and used the power of hundreds of lighthouses, have been reduced to microscopic lines on a piece of silicon half the size

of your little fingernail, using the power of a child's nightlight.

### A Sort-of-Short History

Many of us (I hope) remember when televisions and radios were run on vacuum tubes. They were large (certainly far from portable) and gave off a lot of heat. Do you recall when the switchover began, first to transistors and then to "solid state"? I was only a kid, but I remember how progressive it was in the mid-fifties to have a transistor radio (look, Ma, no tubes!) that you could actually *carry around* with you. And then in the sixties came solid state televisions—also smaller, lighter—and significantly less power hungry—than the old ones.

Behind the scenes what had

happened was the invention, first, of the transistor in 1947, and then finally of the integrated circuit (IC) around 1960—both using the properties of semiconductors to create, first, electrical components that replaced vacuum tubes and finally complete electrical circuits.

Let's stop here for a minute and talk about semiconductors and integrated circuits, since they are the crucial developments that made all this possible to begin with. A semiconductor, as its name suggests, is a material that is not quite an electrical conductor (like copper is) and not quite an insulator (like glass or rubber), but can sometimes be one or the other. I know that sounds like something out of Lewis Carroll, but it's not as wacky as it seems.

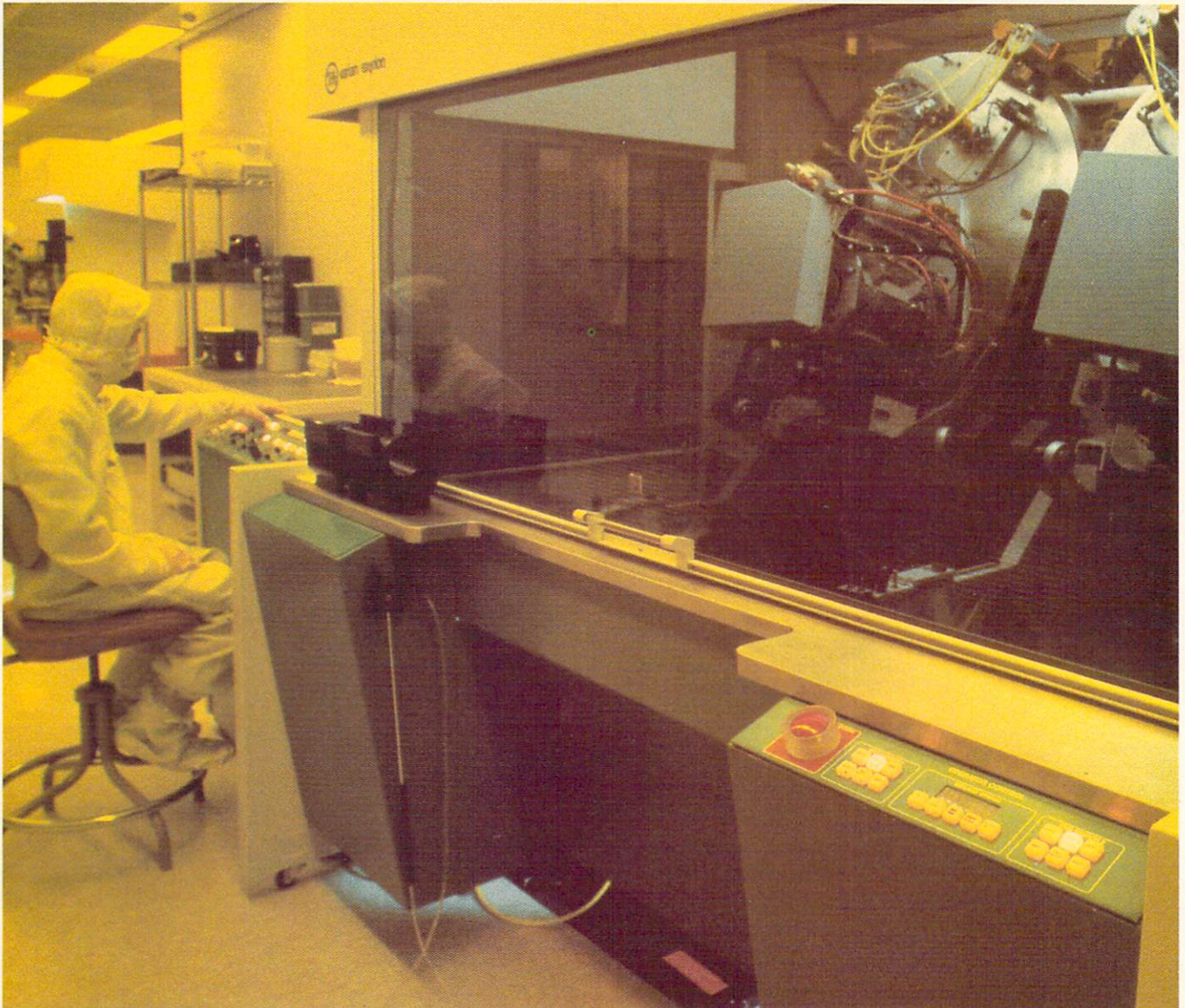

In the metallization process wafers receive a coating of silicon dioxide or other material.



## High-Tech Glossary

**Bi-polar transistor** A transistor formed by sandwiching either a negatively doped region between two positively doped areas, or vice versa.

**CAD (computer-aided design)**

Used as a tool in designing integrated circuits. Information about past circuits, stored in a data base, is combined with data about the function of new chips to enable the CAD system to design a new circuit.

**Chip** The nickname for an integrated circuit formed on a tiny piece of semiconductor material.

**Diffusion furnace** A high-temperature furnace used in making chips. It diffuses dopants into silicon wafers, which transforms the silicon into a semiconductor material.

**DIP (dual in-line package)** The protective packaging, resembling a caterpillar with stubby metal legs, that houses a chip. It is usually made of plastic but can also be ceramic.

**Doping** The process of selectively introducing impurities (called dopants) such as phosphorus, boron or arsenic into a pure material like silicon or germanium to create a semiconductor.

**IC (integrated circuit)** A group of inseparably connected circuit elements formed on and within a single substrate, usually silicon.

**Ion Implantation** A very precise method of introducing impurities into silicon to create a semiconductor material. Single ions of dopants are shot into the silicon under carefully controlled conditions.

**LSI (large-scale integration)** Generally applied to integrated circuits containing 40,000+ transistors.

**Microprocessor** An integrated circuit designed to carry out commands and do calculations.

**MOSFET (metal oxide semiconductor field-effect transistor)**

A transistor formed by creating islands of negative and positive silicon connected by a channel of silicon dioxide, over which a layer of metal is deposited.

**Photomask** Used as part of the photographic process in making chips. It protects (masks) the areas that should not be exposed to light, so those areas can later be etched.

**Planar process** A commonly used method for creating integrated circuits. A layer of silicon dioxide is formed on the surface of a silicon wafer and is then photolithographically patterned to permit the introduction of dopants.

**Plasma etching** A process in chip making. After a wafer has gone through photolithography certain areas are etched using an excited chemical vapor called a plasma.

**Reticle** A picture in negative of one layer of a circuit. Reticles at MOS Technology, Inc. are created on glass coated with photosensitive emulsion and are usually ten times the final size of the circuit.

**Semiconductor** A material that is less of a conductor than copper but more of a conductor than glass, whose electrical properties can be altered to suit specific needs.

**Silicon** An element used in pure crystal form as the base material for many kinds of integrated circuits.

**SINCAP** The final protective coating on a wafer. Composed of silicon nitride, it prevents damage to the microscopic circuits.

**Solid state** Electrical functions carried out in a solid medium.

**Transistor** A semiconductor device that acts as either an amplifier or current switch.

**VLSI (very large-scale integration)** Integrated circuits that contain as many as 100,000 transistors and up.

**Wafer** A thin disk of semiconductor material, usually about five inches in diameter, on which hundreds of identical chips are fabricated.

**Yield** The percentage of usable chips produced by the wafer fabrication process.

Semiconductors are made (they are indeed made, not born) by adding specific impurities (usually boron, arsenic or phosphorus) to an extremely pure material like silicon or germanium. (The process of adding the impurities is called "doping".) The impurities generally cause the silicon (or germanium) to conduct electricity when it ordinarily wouldn't. If you place the impurities very precisely (you'll see what I mean by "precisely" a little later) you can make electricity do whatever you need it to do—stop, go, amplify—whatever.

The most effective semiconductors developed so far are metal oxide semiconductors, which is where the acronym MOS comes from. And the most effective transistors are metal oxide semiconductor field-effect transistors, also known as MOSFETs. Just in case you ever need to know.

Integrated circuits, which are complete electrical circuits made out of one piece of semiconductor material, grew up almost simultaneously with semiconductor technology. In an integrated circuit, all the components are fabricated on and within a single "substrate", which, in the case of your computer's circuits, is usually silicon.

Contrast the integrated circuit with other circuits you may have seen that are composed of "discrete" or separate components—resistors, capacitors, transistors (or vacuum tubes, if they're really old)—all wired together. You'll notice one thing right off—integrated circuits can be a whole lot smaller. That means, for one thing, that they're faster (less distance for the current to travel) and draw a lot less power. They're also a whole lot cheaper to produce. And, as fabrication processes continue to be refined, they keep getting even smaller—and cheaper.

I won't go beyond that, since we'll take a close look at the process a little later as we tour MOS Technology. But before I change the subject, I should mention that people were messing around with semiconductors for quite a while



before Bardeen, Brattain and Shockley at Bell Laboratories finally figured out, in 1947, how to make a successful transistor. (That discovery, coincidentally, was made almost exactly 36 years ago, between November 16 and December 17.) In fact, in the early 1900's—several years even before the invention of the vacuum tube—people had been trying to use crystal detectors (made from semiconductor materials) in radios, but their performance was too erratic to make them marketable.

The early transistors, as you may remember, also had their

limitations. They looked rather like little three-legged stools, and were inclined to fall off the circuit boards. However, once transistor technology got rolling, discovery rapidly followed discovery until in the mid-1950's engineers learned to use photolithography to define transistors on the surface of a solid such as silicon (more on this later). Then they realized that all necessary electrical components—not just transistors, but also resistors and capacitors—could be made from semiconductor material and fabricated in place in a solid, all of which led finally to the creation of integrated circuits on (and in)

solids like silicon—and the now familiar microchip.

As you might suspect, much of the original support for creating miniature electrical components came from the military establishment, which was looking for a way to put a lot of complex electronics into their weaponry and equipment. Obviously, existing electronics like the 30-ton ENIAC computer that was around in the 1940's wouldn't fit well in a bomber, so after World War II various branches of the military had begun supporting a fair amount of research toward scaling things down. Naturally, the

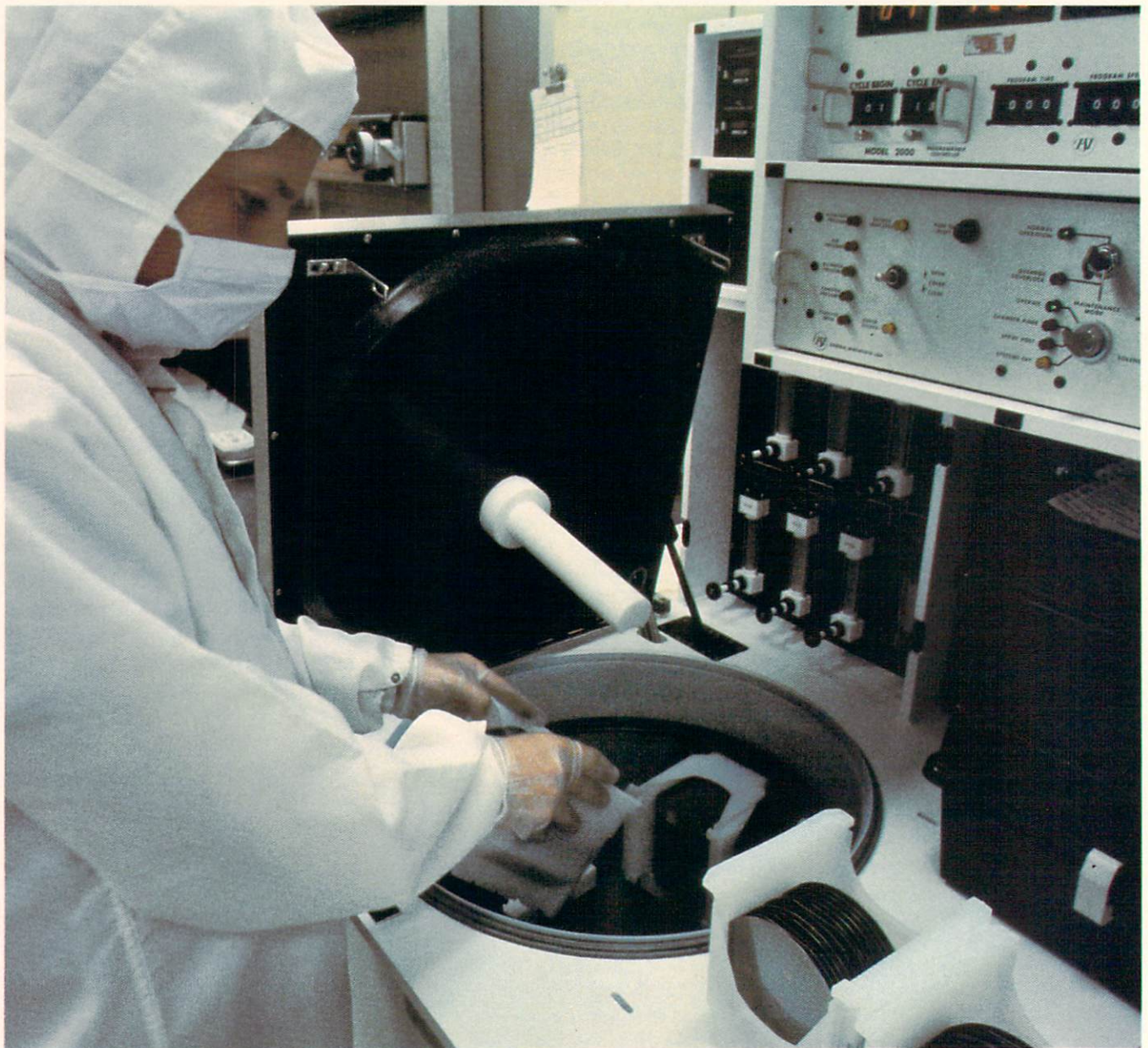

*Wafers are carefully cleaned before each operation.*



first attempts were at making miniature versions of conventional components, none of which was very successful.

Ironically, however, when the integrated circuit was finally developed in the late fifties, the Air Force was already supporting a different branch of research called molecular electronics and the Army was committed to work on a "micro module", which used miniature electron tubes in a ceramic substrate. Consequently, as the politics of these things go, the integrated circuit was mainly ignored for a while.

Nevertheless, the story of the IC, as we all know, had a happy ending in spite of early neglect. As fabrication processes were refined and chip "yields" increased—that is, more chips made it successfully through fabrication in working order—it became impossible to ignore the fact that IC's were cheap, doing for pennies what used to cost hundreds of dollars. So even though it took a while to catch on in any far reaching way IC's were used in military and space applications fairly early on. Then you began to find them controlling production processes in factories, and showing up in consumer appliances like televisions, washing machines, dishwashers, fire alarm systems and even toys.

Then came large scale integration (LSI), which meant more transistors and more circuitry on a chip. How much more? Well, in the early 1960's IC's contained maybe 400 transistors. On the other hand, LSI circuits contain maybe 60,000 transistors—a number that has consistently been climbing.

Now we get to the good part—1971. That's when Ted Hoff at Intel, which was then a two year-old company, developed the first IC that worked as a microprocessor. It could do more calculations faster, all in a quarter-inch flake, than our old 30-ton friend ENIAC could do only 25 years before. This is where we came in.

## From Sand to Microcomputer: How a Chip is Made

Actually MOS Technology, Inc., the subsidiary of Commodore that produces the chips that go in your computers, made other semiconductor devices before they started making microcomputer circuits. Originally the chips they made were for controlling home appliances, factory production processes and other kinds of electronic systems. Then in 1974 they developed the 6502 microprocessor, which is really where we came in.

However, whether the IC on a chip is running a washing machine or a computer, the basic fabrication process is the same. The process is similar, in a general way, to silk screening or batik. In those processes artists expose certain parts of a design to color, while protecting other areas with wax or a similar substance. Then they switch, and expose new parts of the design to a different color while protecting yet other areas. They build up colors by protecting and exposing until they get the effect they want.

Similarly, layers of circuitry are built up on the surface of a chip using a photolithographic process that exposes certain parts of the silicon to specific chemicals but protects others, then switches and exposes *different* parts of the surface to perhaps *different* elements while protecting yet others—until all the layers are in place.

### Design

The first step in designing an LSI circuit is to define the "architecture" or what the chip is supposed to do and how it will do it. The design engineer then uses computer simulations to help define the exact circuitry requirements and a layout specialist draws the final circuit—on a much larger scale than the final chip will be, of course. However, on a device that might include 100,000 transistors, you can't draw every element. So the layout specialist will draw, for instance, one cell of a

64,000-cell random access memory, which is then digitized, converted to a computer data base and duplicated with the help of a CAD (computer-aided design) system.

Once the circuit is edited and stored in a new data base, the computer checks to make sure no design rules have been violated. This checking process alone could take years if done by hand, but takes the computer only a few hours. A variety of cells, each representing a different function, can also be stored in the computer at this time for use in future circuits.

Finally the complete design data base is converted to magnetic tape and sent to the first step in the fabrication process—photomask.

Before we talk about the photomask process, however, you need to know a few things about wafers, since every chip starts out on a wafer—along with hundreds of sibling chips. Wafers are just what their name implies—thin, round slices of pure silicon. They're made by melting sand, removing the impurities and crystalizing the remaining silicon into a single-crystal log about five inches in diameter. The log-shaped crystal is then sliced into thin disks, polished to mirror smoothness and voila! a wafer. One wafer becomes the birthplace for perhaps 400 chips.

In the "planar process" commonly used to create integrated circuits, these silicon wafers are coated with a layer of metal or silicon dioxide, a super insulator, and are then photolithographically patterned, using the following processes.

### Photomask

When the magnetic tape containing a complete circuit design comes into the MOS wafer fabrication plant, it goes to the mask shop. The mask shop then produces a negative of the circuitry, at ten times its final size, on photosensitized glass. One four-inch square of glass, called a reticle, contains one layer of circuitry, so in a complex circuit they might



have to create, say, four or five different reticles.

Each reticle is then used to create a "mask" for that layer. Using another photographic process, the circuitry on the reticle is reduced to its final size (usually about a quarter of an inch on a side or smaller) and through a "step and repeat" process, reproduced over and over again on another piece of photosensitive glass, until the final mask contains several hundred exact reproductions of that layer of the circuit.

Now we get to the wafers. The final mask is inserted into a photolithographing machine along with a wafer that's been coated with a photosensitive material called photoresist. Light shines through the mask and exposes the photoresist, which hardens it. The parts of the photoresist that are *not* exposed, however (those areas where the mask blocks out the light), stay soft. The soft photoresist is removed, exposing the material underneath, which might be a metal or might be an oxide coating that's been put on the wafer, depending on the specs for that particular circuit. Thousands of wafers might go through this process for each layer of circuitry.

As you can guess, when you're working with microscopic circuits, any slight change in conditions has a devastating effect and a particle of dust is like a boulder. So all this (and most of the remaining processes) takes place in a "clean room", where temperature is controlled to within one degree Fahrenheit, humidity is held constant and particles are almost completely filtered out—the perfect work environment for anyone with allergies. People who work in these clean rooms wear special coveralls, booties and hair coverings. Even mustaches and beards must be covered.

### **Plasma Etching, Diffusion, Ion Implantation**

Wherever the photoresist on a wafer has been removed in the



*Wafers are inspected under black light prior to processing.*

photolithographic process it will be exposed, in the next step, to a "plasma" or excited chemical vapor to achieve a desired effect. In the past, liquids rather than vapors were used in this step, but the areas to be etched eventually became so small that liquids couldn't get into them anymore.

Depending on the specific circuit, the wafer may then go to either the diffusion furnace or to ion implantation. This is where impurities like boron, arsenic or phosphorus are added to create layers of semiconductors. Which chemicals are used and when, where they are placed on the wafers and the method used to place them are all determined by the needs of the individual circuit design.

One method of doping, or adding impurities, is with a diffusion furnace, which operates at temperatures up to about 1000 degrees centigrade. Wafers are loaded into quartz racks and advanced at a programmed rate into the furnace. The appropriate chem-

ical gases are then circulated in a specific order, called a "recipe" (the language used in these processes sure is food oriented, isn't it?), to achieve a desired effect.

For newer, more complex circuits the diffusion process is sometimes not the best method. In that case, ion implantation is used. The ion implantation equipment does just what you think it does—it shoots individual ions of the appropriate chemical into the silicon. The number of ions and the depth at which they are implanted are crucial and are carefully controlled, which is probably an understatement.

### **Capping it Off**

After about three weeks of going back and forth among these various processes, the wafers are finally finished. They're then coated with a protective layer of silicon nitride (known as SINCAP) and go through one more photolithographic process to expose the tiny connector pads around each chip (they won't be much good if



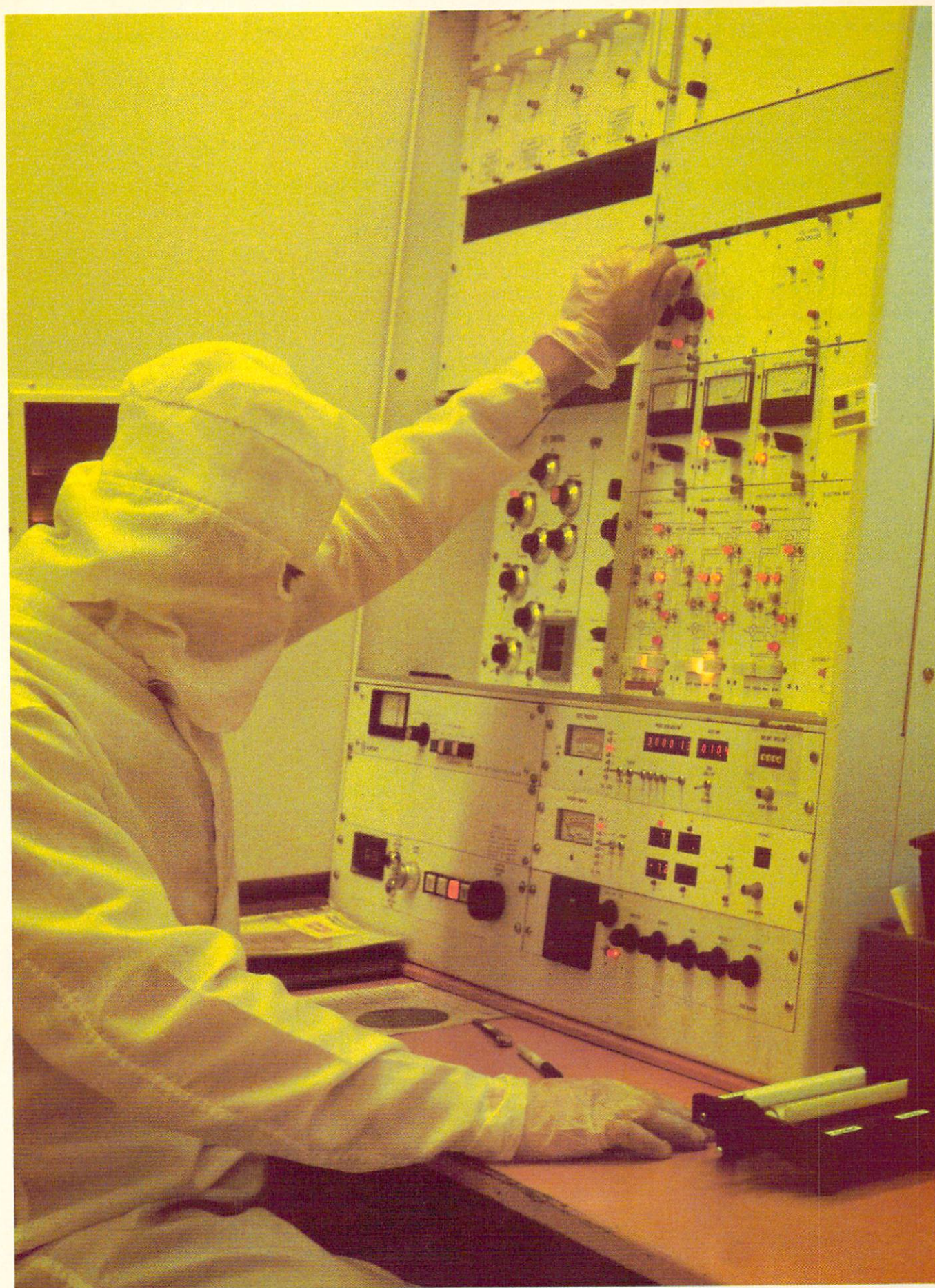

Newer, more complex circuits are sometimes "doped" using extremely accurate ion implantation. This is the implanter control panel.



electricity can't get in and out).

Before the wafers get cut up into individual chips they go through a final test called "wafer sort". In this process, tiny (and I mean tiny) mechanical "fingers" make connection with each individual chip on a wafer. The fingers are connected to a computer that determines whether the chip is working properly. If it isn't, the chip is marked with a little dot of ink. Industry-wide, the yield of good chips is usually less than 50%, so you can see why it is important to find the bad ones *before* you go through all the cutting and packaging processes.

### Packaging

Finally the wafers are cut up into individual chips using an extremely precise diamond saw and are wired into their DIPs (remember the caterpillars?).

Of course, there's wiring like you normally think of it and then there's wiring chips—with gold wire finer than an infant's eyelash, under a microscope.

At last the lids are put on if it's a ceramic DIP—or the plastic is injection-molded around the chip if it's not—and you've got yourself a completed "device", ready to go into your computer—or dishwasher. Just hope they don't confuse the two, or you'll end up with a rebellious dishwasher that entertains your kids and calculates your water bill instead of scrubbing pots.

It's almost a cliché by now, but I'm going to say it anyway. In the future, you can bet that IC's will continue to get smaller and more complex, so you will be able to do a whole lot more with much less. For instance, new discoveries that increase photographic resolution

continue to influence the processes used in chip making. The size of circuits, after all, is determined at least in part by how fine the resolution can be when you're making a photomask. And as computers design new computers, the cumulative effect could be staggering.

But you can read that kind of conjecture anywhere. I just wanted, mainly, to give you the facts. So there they are. Hopefully you won't ever have to sink ashamedly into the shadows again when your techie friends start to talk about things like semiconductors, integrated circuits and chips.

### References

*National Geographic*, October, 1982, offers a very detailed, yet eminently readable explanation of microchips and the surrounding technology, aimed at the layman. *Scientific American*, September,

## Important Dates in Microcomputer History

**1642**—Geared adding machine invented by French mathematician Blaise Pascal (then 19 years old). Later improved upon by Gottfried Leibniz.

**1820's**—"Difference Engine" created by Charles Babbage in England to calculate precise astronomical tables for navigational use.

**1830's**—"Analytical Engine" designed by Charles Babbage. It was to have a memory that could hold a thousand fifty-digit numbers and a "mill" to perform arithmetic operations. He proposed that information be fed into the Analytical Engine on punched cards, like those used at the time in advanced weaving looms. Although the Analytical Engine was beyond the scope of metal work of the time and could not be constructed, Babbage is still considered the father of the computer era.

**1880's**—Fast punched-card data system invented by Herman Hollerith to help the U.S. Census Bureau process data collected in the 1880 census. Paved the way for electronic sorting of data.

**1884**—"Comptometer Business Machine" built by Dorr E. Felt, using meat skewers, rubber bands, staples and a wooden macaroni box. It performed general purpose multiplication and division and eventually became one of the most important business machines of the early 20th century.

**Early 1900's**—First use of crystal radio detectors (early point-contact diodes, which used semiconductors).

**1902**—Development of the vacuum tube by Ambrose Fleming.

**1944**—The first "real" computer, Harvard's Mark I automatic general purpose digital calculator, developed by IBM in conjunction with Harvard. Howard Aiken, one of its developers, called it "Babbage's dream come true."

**1945**—Development of ENIAC (Electronic Numerical Integrator and Calculator), the first digital electronic computer. It weighed 30 tons, occupied a room 30 feet by 50 feet and contained 18,000 vacuum tubes. The only way to change a program was to rewire the machine. Its developers believed that about four of these machines could handle the computational needs of the entire United States.

**1945**—EDVAC (Electronic Discrete Variable Automatic Calculator) introduced by John von Neumann of Princeton University. The first to use on-off switches to represent instructions and data, and the first to allow both data and the program itself to be stored in memory.

**1947**—Creation of the first commercial semiconductor, the bi-polar transistor, by William Shockley, Walter Brattain and John Bardeen at Bell Labs.



1977, contains a more technical, maybe not so readable, but very useful explanation of microelectronics for the more engineering-minded.

*Technology Illustrated*, February/March, 1982, presents somewhat superficial but nevertheless helpful information on chips. Workman Publishing's *1984 Computer Desk Diary* is a good place to find interesting tidbits about computing (like the source of the word "robot") and photos (like one of the original ENIAC computer).

For even more, check your library's *Reader's Guide to Periodical Literature*, starting about 1972—especially the articles that appeared in magazines like *Popular Electronics* and *Popular Science*. Some of them, I might add, are good for a laugh, as well as a source of information. **C**

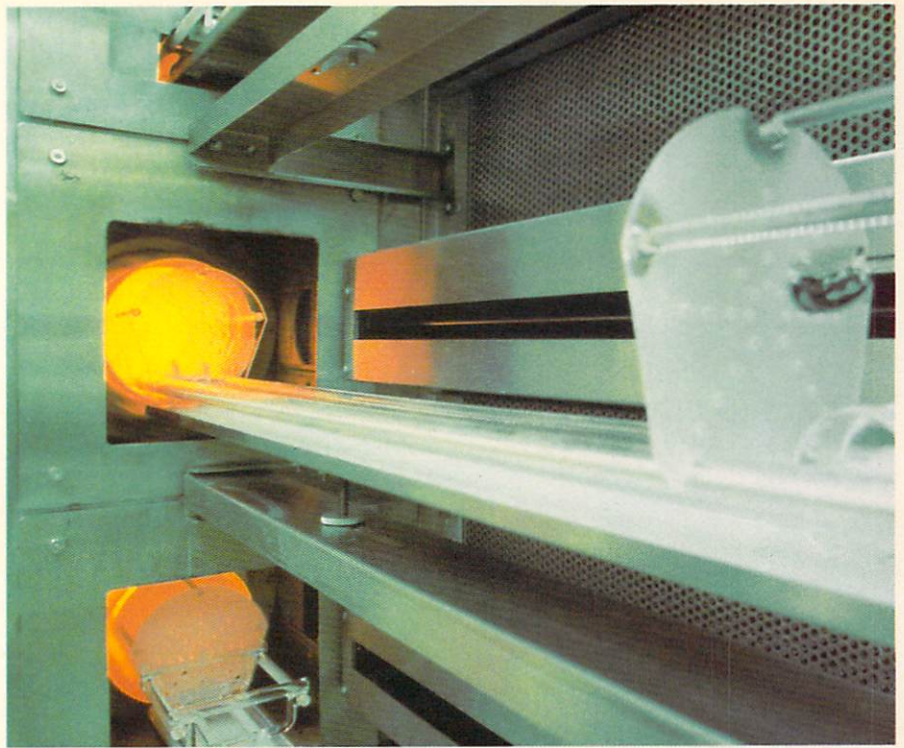

The diffusion furnace, where wafers receive selective "doping" with impurities like boron, phosphorus or arsenic.

**1951**—Development of printed circuits by Danko and Abrahamson of the U.S. Army Signal Corps.

**1951**—Jay Forrester patents first core memory, allowing computers to have fast random access storage of large amounts of information.

**1952**—Possibility for developing semiconductor integrated circuits first perceived by G.W.A. Dummer of the Royal Radar Establishment in England.

**1955**—First field-effect transistors built and tested. But unstable fabrication processes, resulting in poor yields, prevented mass production.

**1956**—First computer kit marketed by Heath Company. The cost was \$700.

**1957**—Development of the planar process by Robert Noyce and Gordon Moore at Fairchild Semiconductor, based on work by Frosch and Derrick at Bell Labs and others.

**1959**—Development of the first integrated circuits as we know them (in "chip" form) at Fairchild Semiconductor and Texas Instruments.

**1961**—Robert Noyce awarded the patent for the integrated circuit. The world hardly notices.

**1962**—First practical fabrication of the MOSFET (metal oxide field-effect transistor) and development of the MOS integrated circuit.

**1967**—Major MOSFET fabrication problems solved, resulting in increased chip yields and reduced costs.

**1968**—First MOS memory chips, containing 64 to 256 bits of random access memory.

**1970**—First MOS calculator chips introduced. First 1-kilobit (about 128 bytes) fully decoded RAM introduced.

**1971**—First central processing unit (CPU) on a single microchip developed by Ted Hoff at Intel. Paved the way for the first microcomputers, which were developed shortly thereafter.

**1972**—First general-interest magazine article about microcomputers: *Business Week*, May 12, "Microcomputers Aim at Huge New Market".

**1974**—6502 microprocessor developed at MOS Technology, Inc.

**1975**—Commodore acquires MOS Technology, Inc.

**1977**—First PET microcomputers marketed, containing 8K RAM.

**1980**—Improved fabrication processes allow individual chips to contain up to 60,000 transistors.

**1981**—First easily affordable, full-featured home computer, the VIC 20, introduced by Commodore.

**1982**—Introduction of the Commodore 64, with more capabilities than many expensive business systems, at a low consumer price.

**1983**—Microcomputers become as affordable and as common as many home appliances.

**1984**—The best is yet to come. **C**



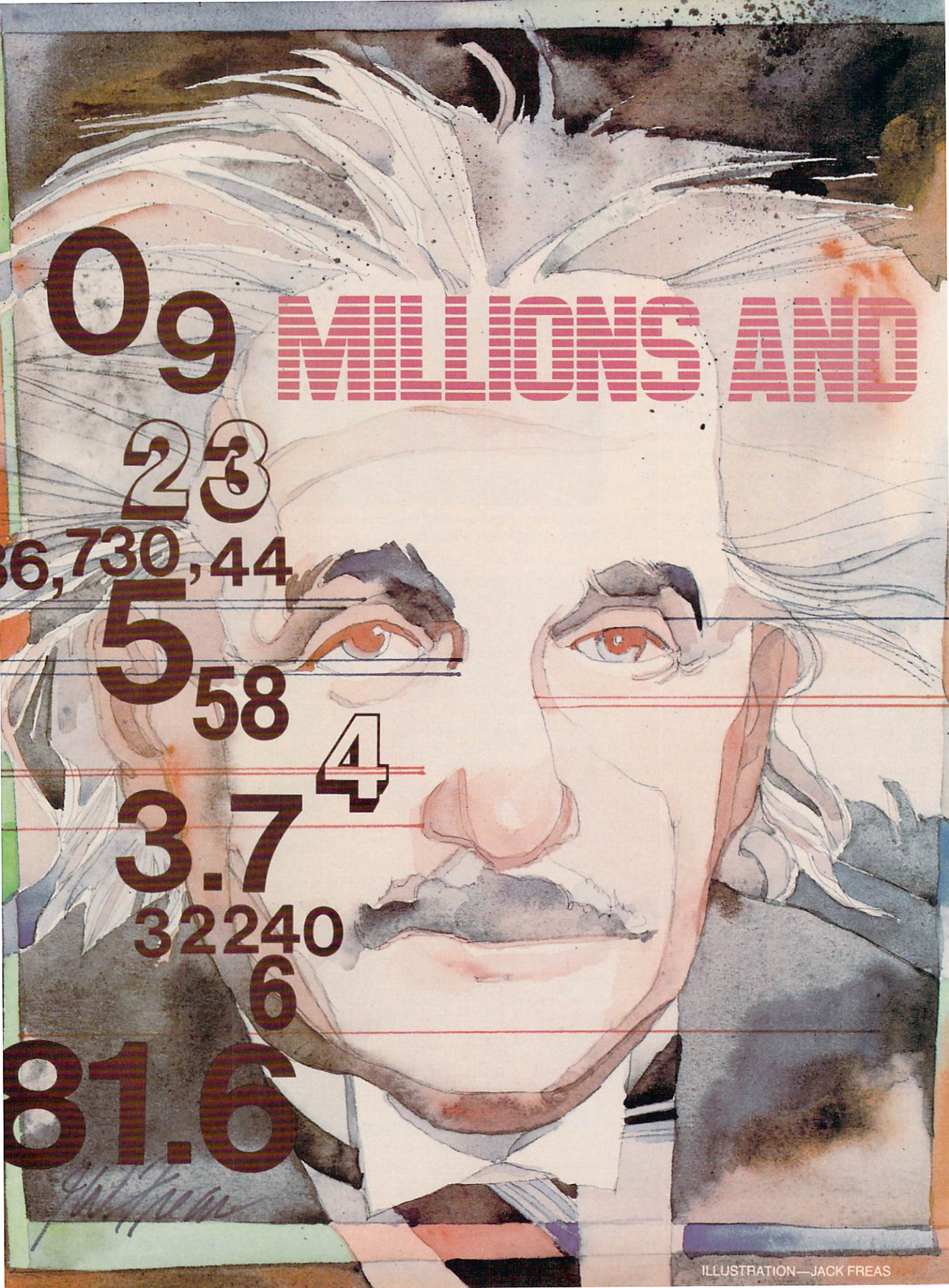

09 MILLIONS AND

23

6,730,44

558

4

3.7

32240

6

81.6



*Thanks to modern technology, your computer deals with measurements on the scale of millions. There's a dot clock that ticks over eight million times a second and chips with components no larger than 50 millionths of a meter. In this article we'll look at the scales of both time and size as they relate to the 6502 chip.*

---

---

# THE MICROCHIP

---

---

By Jim Gracely

**B**ig numbers are both mysterious and fascinating. Small numbers are just about the same as big numbers. When we want to describe something bigger than anything else we just use a number like "million": "You'll never guess in a million years", or "There must be a million of them", are both common statements. Once a number gets big enough, we lose any concept of how much it really is.

Here is an interesting example to test your skills in large numbers. Without the use of a calculator (or computer) choose which of the following represents the most money.

1. Two tons of gold (market price as of October 11, 1983)?
2. A dime for every inch between New York city and Los Angeles?
3. A nickel for every yard between the earth and the moon?

In this example, the scale of units involved is much greater than anything we're used to dealing with. The largest amount above is \$25,280,000. I'll tell you

which one adds up to that later. How much is twenty five million dollars? Well, if you used it to buy gasoline, you could fill a car with a 15 gallon tank every day for 3802 years!

## Time

How does this relate to micro-computers? The clock crystal in the VIC and 64 has a frequency of 1Mhz. This means that it "ticks" one million times a second. Many machine language commands (such as INX and CLC) are executed in two ticks! That means that they take two millionths of a second to execute.

Now we're going to change the scale of the computer's clock and make each tick one second (multiply the clock by a million). This way we can more readily visualize some of the timing. Now, what used to take the computer one second to perform takes 278 hours or 11.5 days. Here is a chart that compares some "real time" events to the number of ticks and length of time on our new clock.



Real Time Event	How Many Ticks of a 1Mhz. Clock	Length of Time if 1 Tick = 1 Second
1 millionth of a second	1	1 second
1 second	1,000,000	278 hours or 11.5 days
1/60 of a second	16,667	4.6 hours
One "flap" of a house fly's wing. (according to Isaac Asimov—see Bibliography)	3160	53 minutes
Adding 5 and 7 in machine language		
LDA #5	2	2 seconds
CLC	2	2 seconds
ADC #7	2	2 seconds
STA 251	3	3 seconds
<b>TOTAL</b>	9 millionths of a second	9 seconds

This helps to bring a little insight into the speed of the microprocessor. Here is another question for you: If you were to work for 11.5 days straight with only a half hour break every four and a half hours would you consider yourself overworked? This is the analogy to the interrupt routine of the VIC and 64 which occurs 60 times a second. The 4.5 hours is the time spent running your basic program and the half hour break is the interrupt routine.

How long does it take to run a program? Well that depends on what the program does. Using our same expanded clock, let's look at a simple addition problem in BASIC. The addition 5+7 is performed in about .5 milliseconds. This is 500 ticks of the clock or 500 seconds (eight minutes) on our "upscale" clock. Look back at the chart to the short machine language program. That program also added five and seven, but it took only nine seconds. Dividing 500 by nine we find that the ma-

chine language program was over 50 times faster! Even going back to the 500 seconds it took in BASIC, eight minutes out of 11.5 days is still pretty good. In fact we could add five and seven about 2000 times in a million seconds.

We've spent enough time on this subject, so onward. Oh, that's right, about that question at the beginning. If you selected C, you were not correct. The average distance to the moon is 238,900 miles or 420,464,000 yards. At a nickel a yard it comes to \$21,023,200. If you guessed B you were also not correct. The distance from New York city to Los Angeles is 2794 miles. This is 14,752,320 feet or 177,027,840 inches. At one dime on the inch this is \$17,702,784. If you guessed A you were correct!! Congratulations!! On the day I put this quiz together, the price of gold was \$395 an ounce. Two tons is 4000 pounds or 64,000 ounces. At \$395 per ounce this is \$25,280,000.



## Size

We are now going to turn our attention to the size of the 6502 chip. Most people have seen a chip case before (what some call a "caterpillar"). The logical deduction then is to say "so that's a 6502 chip". Well that's not entirely correct. The black plastic or ceramic case with 28 pins ("legs") is actually a container for the 6502 chip. The chip itself is a little silver rectangle (a piece of silicon) about three by four millimeters. This is about the size of the little graphic boxes on the front of your VIC or 64 keys (if you own a PET/CBM computer it's just about the size of the cursor).

However, a little silver square does not a microprocessor make! There must be something on that square you say? Well indeed there is. In fact, there are over 5000 "somethings" on that square. A "something" is known in the electronics world as a component. A component may be a transistor, a resistor or a capacitor (there are others and variations but these are the most common).

Now let's look at the scale of a component that is so small that 5000 will fit on a single chip. If the 6502 chip is three by four millimeters and we divide this down into 5000 pieces, each piece would be about 50 micrometers on each side. This is 50 millionths of a meter. To give you an idea of how small this is we'll compare it to a grain of sand. According to Isaac Asimov (again) a typical grain of sand is about 200 micrometers on a side. We could put 16 of our components on one face of that grain! For those inland-lubbers, the eye of a needle is about one by .25 millimeters (according to Gracely—I got some strange looks trying to measure that!). We could pack 100 of our components in that space!

What if we wanted to enlarge

the component to something of a good size—say a football field. A football field is roughly 100 meters long, so we would need to enlarge our component two million times. How big is the little silver chip now? Well it's two million times bigger or about 3.5 miles by five miles. What about the case or caterpillar? It's normally about two inches long and half an inch wide, but now... it's 64.5 miles long and 17 miles wide. In fact, if we let it sit on its pins or legs it would be almost ten miles high. To take the analogy one step further, how big would the VIC be now? 512 miles wide by 236 miles deep by 74 miles high.

Amazing as this may seem, keep in mind that the 6502 is not a very "dense" chip. In other words, 5000 components on a chip is not that many. On the front edge of technology, with 256,000-bit memory chips, more than half a million components may be on one chip. Going back to our eye of the needle, we could put about 2500 of these components into that space!

Well, that's our little trip through the time and size of the 6502 chip. I realize that this kind of article isn't packed full of useful facts and figures, but that's okay. It is important to stop now and then and think about what you're actually working with. An understanding and appreciation of any machine allow you to work with it properly, use it to its fullest extent and at the same time recognize its limitations.

---

## Bibliography

*The Measure of the Universe*, Isaac Asimov. Harper & Row Publishers, New York: 1983.  
*Microprocessors And Microcomputers*, Ronald J. Tocci and Lester R. Laskowski. Prentice-Hall, Inc., Englewood Cliffs, New Jersey: 1979. **C**





# The Logic of Bits

## Part 2 in a Series

In Part 1, which appeared in Issue 24, Jeff explained the on/off logic of transistors and how the binary number system, which is based on on/off logic, works. In binary, a one represents the "on" condition and zero represents "off". This simple code is used to construct all the systems in your computer.

ILLUSTRATION—ROBERT NEUMANN



# and Pieces

By Jeff Hand

It's amazing that the simplest of concepts can generate the most complex of systems. The genetic code, for instance, which generates all the myriad of life on earth and determines everything about us, is composed of only four compounds. All of the cosmos is made up of only a lit-

tle over 100 elements. Similarly, the computer is based on the simple concept of on/off and a few logic gates, yet look at the complex systems that have been developed. This part of our series will help you unravel some of that complexity.

In Part 1 we saw how the con-

cept of the on/off transistor was developed into the binary, decimal and hexadecimal number systems used in computers. This part will show you how the same on/off (two-state) transistor concept develops into two-state logic and logic circuits and how those concepts are used in





software and hardware applications. Along the way we will pick up some other computer concepts like serial and parallel data transmission, Boolean algebra and encoders/decoders.

As we saw in Part 1, a transistor acts as a switch—it is either on or off. Figure 1 shows a signal, changing over time, that is fed into a transistor, as if you were turning the kitchen light on and off several times. If you remember, Commodore computers are TTL machines—that is, they use transistor-transistor logic—and they use five volts for “on” and zero volts for “off”.

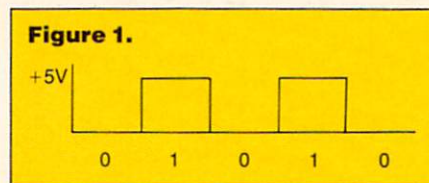

This changing signal can be fed into a transistor as shown in Figure 2. The clock signal is a continuous pulse signal that is used as a timing reference for activities in the computer. In the Commodore computer there are a million clock pulses in one second. I'll explain the importance of the clock signal in a later article, but for now I've mentioned it just to facilitate your understanding of serial transmission.

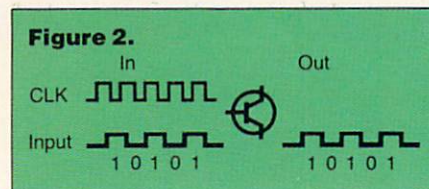

In Figure 2 the information is leaving the transistor in a serial fashion. That means the bits of a word are sent out one after another through a single line, which is kept in sync with the rest of the computer by the clock signal.

Besides the serial method of moving data, there is a parallel method. Parallel transmission occurs when all the bits of a word are moved at the same time over different lines as shown in Figure 3.

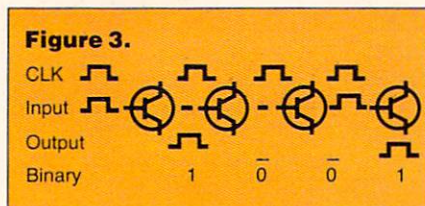

Figures 2 and 3 illustrate the basic difference between serial and parallel information transfer. Now when you hear about a serial interface, like an RS-232 for instance, where the information moves through one bit at a time, you should have an idea of how that method of information transfer compares to a parallel interface.

These signals can represent many types of information. The digital signal can mean one bit of a binary number or one bit of a binary code such as CBM ASCII, or it can be the control signal of an external event coming across an I/O port.

A logic gate operates on one or more inputs and produces one output signal. Logic gates are an arrangement of electronic components like transistors and resistors that act in certain ways on the incoming signals to create the output. Let's take a look at these various components and what they do.

## Inverters

An inverter has only one input. The output signal is always the opposite of the input signal. If a one (five volts) enters the inverter, the output is zero. Conversely if a zero enters, the output is one. The inverter is also known as a NOT gate. Figure 4 shows a schematic representation of the inverter, and includes a logic table.

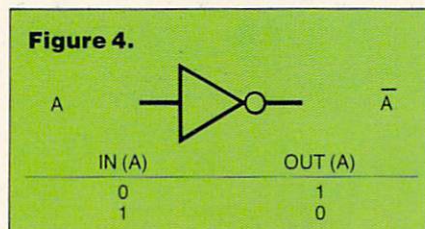

The logic table is more commonly known as a truth table. The truth table is a listing of all the input

possibilities and the associated output for the logic gate. The inverter is easy enough to remember without a truth table but other logic gates can become confusing, which is when the truth table becomes invaluable, as you will soon see.

Boolean algebra is one of the major tools in understanding logic gates and digital computers. It was developed about 1854 by George Boole, a mathematician. It was little used until engineers began using it to design switching relays for telephones. Then, with the advent of computers, Boolean algebra became indispensable for understanding computer logic.

There is nothing difficult about Boolean algebra and as I explain each logic gate, I'll also give you the Boolean symbolic representations for manipulation. For instance, Boolean algebra represent the NOT gate we just discussed with a line over the input. So if the input to an inverter is A then the output is represented by A.

## AND Gate

The distinguishing characteristic of the AND gate is that all input signals must be high (five volts) to produce a high (five volts) output. Figure 5 shows a schematic of the gate and the associated truth table.

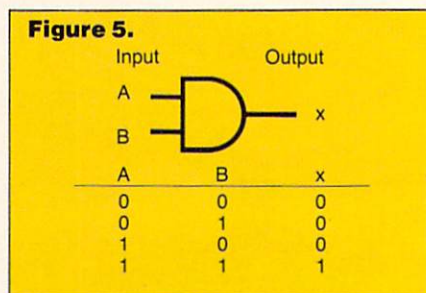

The easiest way to construct the truth table is to count in binary, starting with zero, until all the input values have been covered. Next, place the corresponding output on the righthand side.

Logic gates can have more than two inputs. A two-input gate will generate  $2^2$  or four possibilities. A three-input gate will generate  $2^3$  or eight possible conditions. An easy way to know the total



number of possibilities for a given number of inputs is to use the formula  $2^N$ , where N is the total number of inputs to the logic gate. If you have ten inputs on the gate, the total number of possibilities is  $2^{10}$  or 1024, which is an awfully big truth table for an AND gate, but all you have to remember is the only input combination that will generate a high output is 11 1111 1111.

For the purpose of explaining Boolean algebra, the inputs to the AND gate are labeled A,B,C and so on and the outputs are labeled x. This will also be true in the rest of the gates we'll be discussing.

The Boolean function for an AND gate is the same as normal multiplication. But what makes this algebra so easy is that we have only a one or a zero to multiply with. Therefore our answers can be only zero or one. The Boolean equation can be written in a couple of ways:

$$\begin{aligned} A \text{ AND } B &= x \\ \text{or} \\ A \bullet B &= x \end{aligned}$$

The second version is an abbreviated form, in which the dot is the same operator as in multiplication. These are just two ways of expressing the same AND gate function.

Solving these equations is so easy you're going to wonder why you didn't already know this stuff. Let's go through the AND truth table using Boolean algebra and see if we come up with the same conclusion.

$$\begin{aligned} A \bullet B &= x \\ 0 \bullet 0 &= 0 \\ 0 \bullet 1 &= 0 \\ 1 \bullet 0 &= 0 \\ 1 \bullet 1 &= 1 \end{aligned}$$

You can see that all you have to do is be able to multiply by zero or one. Not too hard. Boolean algebra will simplify your task for what appears to be a tangled mess of logic gates. You can always reduce the mess to Boolean equations of simple multiplication for

the AND gates and addition for the OR gate we'll discuss next.

## OR Gate

The OR gate will produce a high output for any high input. Figure 6 shows a schematic and truth table for the OR gate.

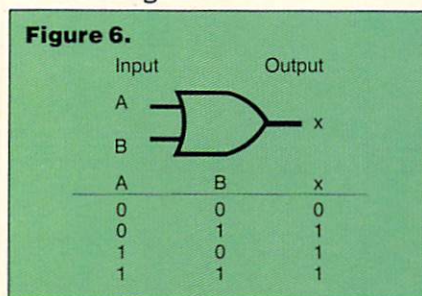

In Boolean algebra the OR gate is equivalent to addition. Here is the general operation:

$$A \text{ OR } B = x$$

This can be rewritten in the Boolean equivalent using a plus sign:

$$A + B = x$$

We can walk through this equation with various input possibilities and see if we come up with the same results as in the truth table.

$$\begin{aligned} A + B &= x \\ 0 + 0 &= 0 \\ 0 + 1 &= 1 \\ 1 + 0 &= 1 \\ 1 + 1 &= 1 \end{aligned}$$

What might confuse you here is how one plus one can equal one. It's because we're working with two-state logic, in which the only numbers are zero and one. It's just a convention that  $1 + 1 = 1$  in Boolean algebra.

The AND and OR gates, along

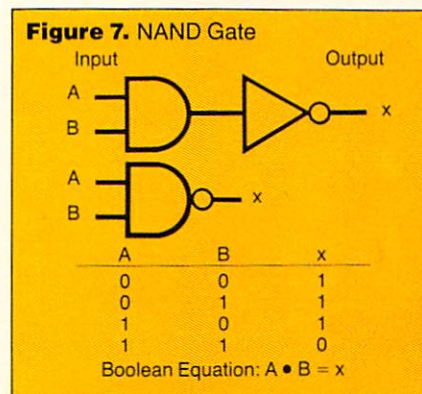

with the inverter, are the major building blocks from which the computer and all of its capabilities are fundamentally built. To give you a little more background, however, we'll look at several more gates in Figures 7, 8 and 9, although these are actually combinations of the three gates we've just discussed.

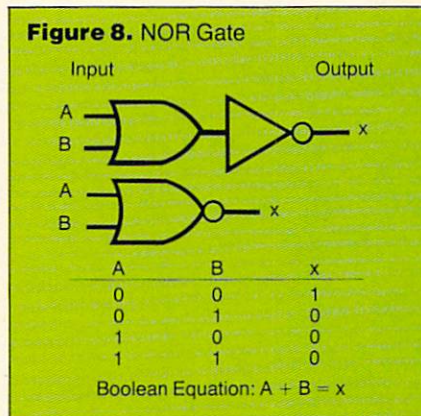

The EX-OR gate in Figure 9 has a high output only when the input levels are different. If the input voltages are the same, then the output is zero. For the EX-OR gate there can be only two input values.

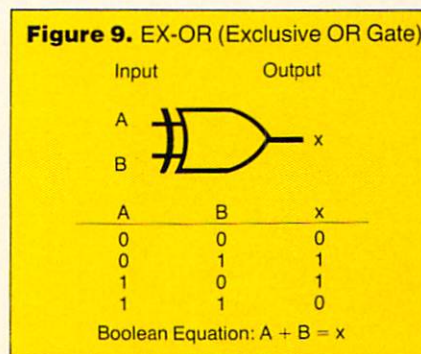

To simplify a generally complex definition, a decoder takes the binary information and usually translates up toward something that mere humans can easily understand. An encoder, on the other hand, takes information and translates it down into the machine's level of ones and zeros.

Figure 10 shows a general diagram of a binary-to-decimal one-of-sixteen decoder.

Now you can use your knowledge of logic gates and Boolean



algebra to figure out how this decoder works. The binary input signals are transported through the lines connected to A B C D. The signal then travels through both the red and green lines at the same time. At each point where there is a dot on either red or green, that signal is then fed into the AND gate. Looking back to the truth

table for the AND gate, you find only all high-input signals will cause the output signal to be high. Let's walk through the first input together. Assume all zeros come through A B C D. Trace the lines through and zero goes through all the blue lines. The inverters change the signal in all the green lines to one. The only AND gate

that has all high inputs is X<sub>0</sub>, which is connected to a display that shows a zero has come through somewhere deep in the computer. We can walk through the entire decoder this way. The Boolean algebra equivalents are also filled in for you. An encoder is shown in Figure 11. This is a hexadecimal encoder.

**Figure 10.** Binary-to-Decimal Decoder

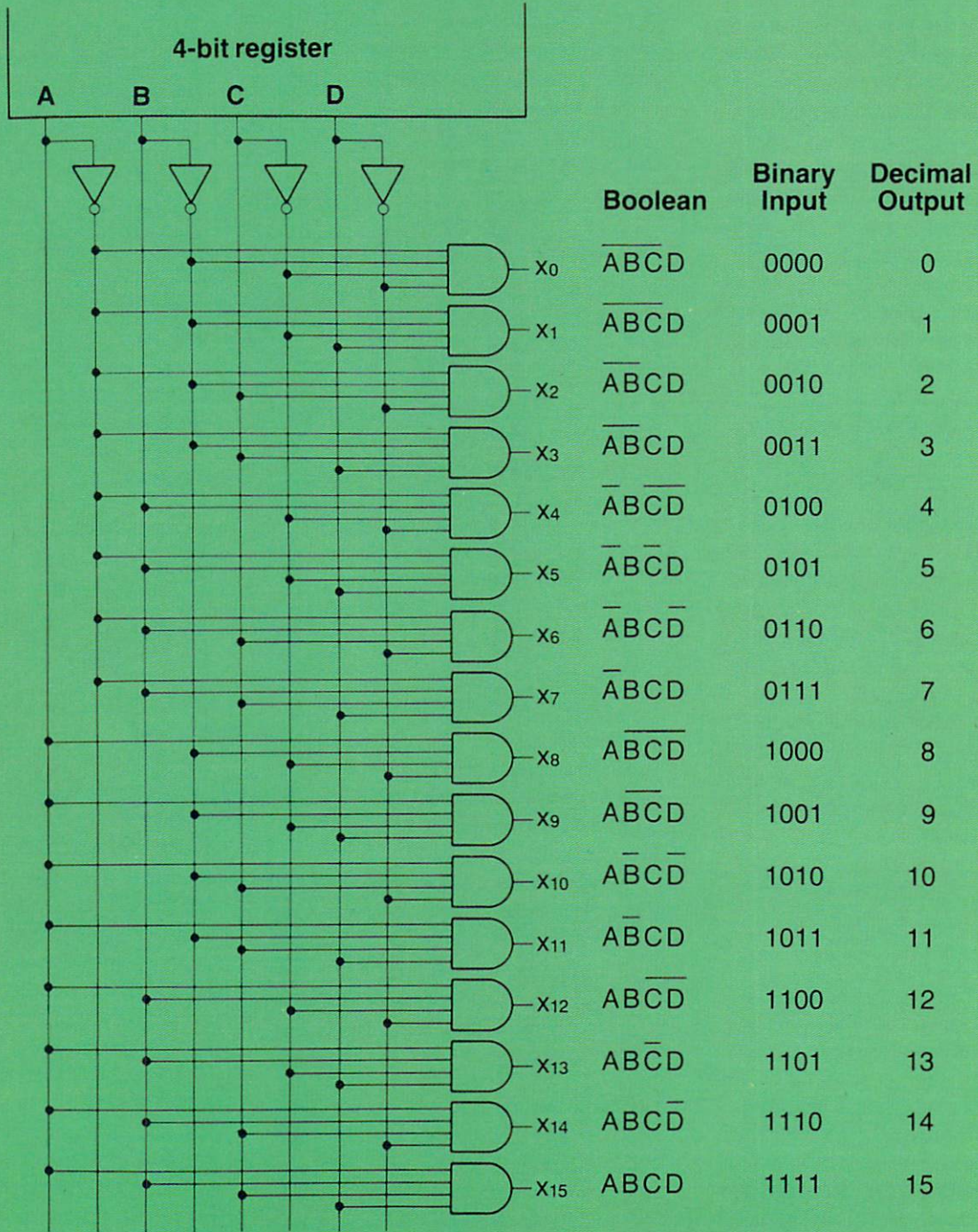



It takes the information, in this case from a keypad on a calculator or computer, and converts that information into a binary form the computer can understand. This is a very simple encoder for illustration and learning purposes, but the phenomenon is the same when you hit a key on your computer, except the encoder is much larger.

If we look back at the OR gate truth table we see that only high input will produce a high output. For example if we hit the "A" key we can see that the A switch goes down and five volts is sent down the line. This produces a high signal in the X3 or X1 OR gates, which translates to 1010 in binary or a ten in decimal. This gate goes only to hexadecimal Fa (decimal

15, which is actually 16 including 0), but a normal eight-bit word can generate 256 different combinations of decimal or FF(hex) possibilities. You can see the matrix gets rather large and cumbersome to use.

The encoder and decoder should give you some idea of the building blocks used in computer hardware. Now we will turn our attention to how logic can be used in software applications.

In programming, logical operators generally are used to test for a bit within a byte or a particular occurrence. For example we could store information coming through the I/O port. Say you have to keep the temperature in a room above 80 degrees. If the temperature stays above 80 your thermometer

interface puts zeros in the I/O port. But if the temperature drops below 80, a one is placed in the I/O register.

The program would then take the information in the I/O register and place it into, say, register 400. Your next step is to take the contents of register 400 and test it. "AND" the contents of register 400 with a 1. Out of all the combinations possible the result will be zero, except if there is a one in register 400. From here your program can branch to get the temperature back up to 80 degrees in the room.

Part 3 in our series will explain two's complement and simple math operations.

C

**Figure 11. Hex-to-Binary Encoder**

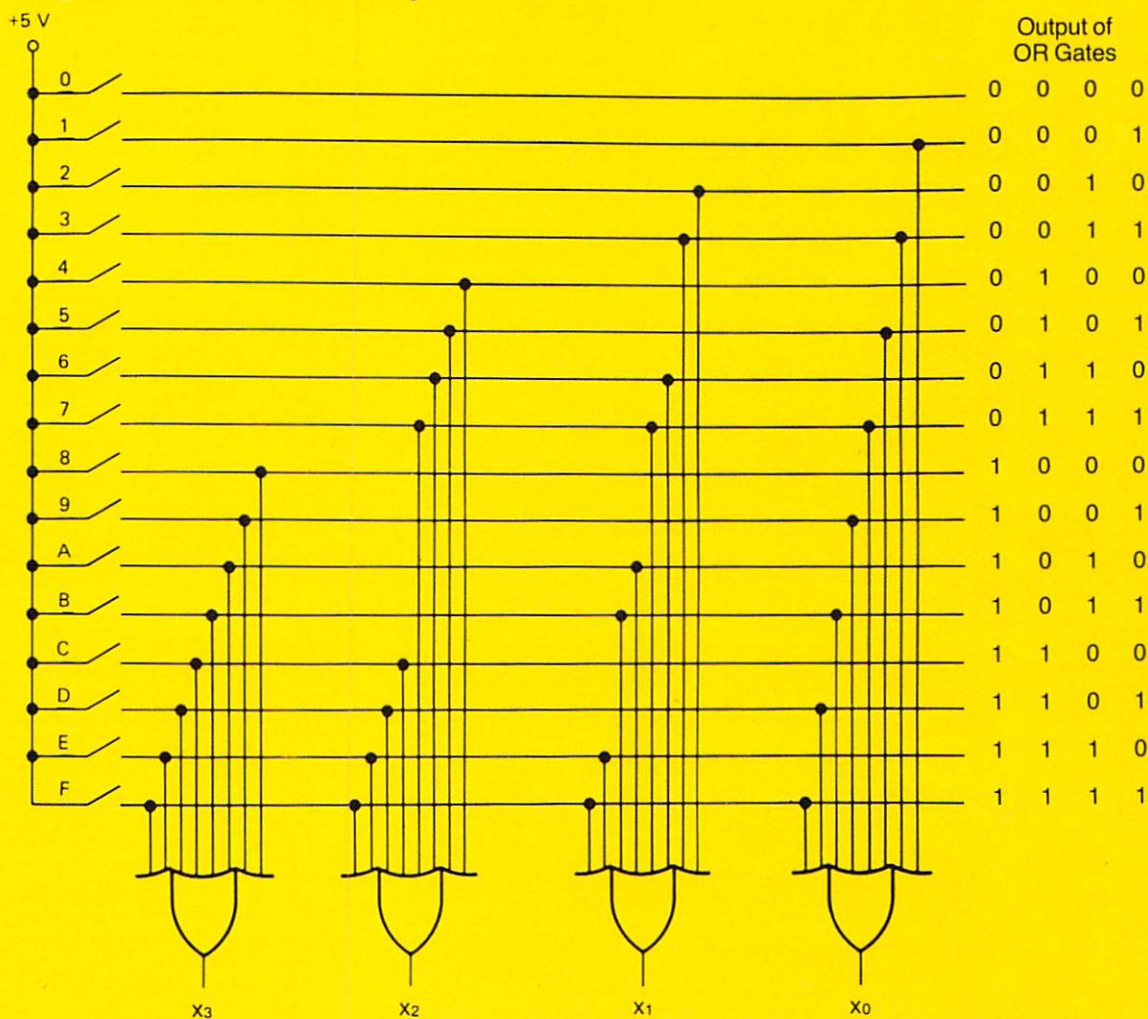



---

# 6502 OP- CODES

Condensed By Jim Gracely

*We get a lot of questions concerning the op-codes for the 6502. People buy the VIC or 64 Programmer's Reference Guide and see all the tables of op-codes. However, these guides don't explain what the op-codes do or how to use them. One very important piece of information about each op-code is how it effects the processor status register. In fact, even some of the textbooks on machine language lack this information. Here then is a list of all the 6502 op-codes with a short description of what they do and how they effect the status register. By the way, for those of you who may be wondering, the 6510 in the 64 uses the same set of op-codes as the 6502.*

---

This information was condensed by Jim Gracely from the *MCS6500 Microcomputer Family Programming Manual* published by MOS Technology, Inc. Unfortunately this book is no longer in print, although you may find copies of it in your local public or college library.

---



---

### **LDA: Load Accumulator with Memory**

When instruction LDA is executed by the microprocessor, data is transferred from memory to the accumulator and stored in the accumulator.

LDA affects the contents of the accumulator, does not affect the carry or overflow flags; sets the zero flag if the accumulator is zero as a result of the LDA, otherwise resets the zero flag; sets the negative flag if bit seven of the accumulator is a one, otherwise resets the negative flag.

### **STA: Store Accumulator in Memory**

This instruction transfers the contents of the accumulator to memory. It affects none of the flags in the processor status register and does not affect the accumulator.

### **ADC: Add Memory to Accumulator with Carry**

This instruction adds the value of memory and carry from the previous operation to the value of the accumulator and stores the result in the accumulator.

This instruction affects the accumulator; sets the carry flag when the sum of a binary add exceeds 255 or when the sum of a decimal add exceeds 99, otherwise carry is reset. The overflow flag is set when the sign or bit seven is changed due to the result exceeding +127 or -128, otherwise overflow is reset. The negative flag is set if the accumulator result contains bit seven on, otherwise the negative flag is reset. The zero flag is set if the accumulator result is zero,

otherwise the zero flag is reset.

### **SBC: Subtract Memory from Accumulator with Borrow**

This instruction subtracts the value of memory and borrow from the value of the accumulator, using two's complement arithmetic, and stores the result in the accumulator. Borrow is defined as the carry flag complemented; therefore, a resultant carry flag indicates that a borrow has not occurred.

This instruction affects the accumulator. The carry flag is set if the result is greater than or equal to zero. The carry flag is reset when the result is less than zero, indicating a borrow. The overflow flag is set when the result exceeds +127 or -127, otherwise it is reset. The negative flag is set if the result in the accumulator has bit seven on, otherwise it is reset. The Z flag is set if the result in the accumulator is zero, otherwise it is reset.

### **AND: Memory with Accumulator**

The AND instructions transfer the accumulator and memory to the adder which performs a bit-by-bit "AND" operation and stores the result back in the accumulator.

This instruction affects the accumulator; sets the zero flag if the result in the accumulator is zero, otherwise resets the zero flag; sets the negative flag if the result in the accumulator has bit seven on, otherwise resets the negative flag.

### **ORA: "OR" Memory with Accumulator**

The ORA instruction transfers the memory and the accumulator to the adder which performs a

binary "OR" on a bit-by-bit basis and stores the result in the accumulator.

This instruction affects the accumulator; sets the zero flag if the result in the accumulator is zero, otherwise resets the zero flag; sets the negative flag if the result in the accumulator has bit seven on, otherwise resets the negative flag.

### **EOR: "Exclusive OR" Memory with Accumulator**

The EOR instruction transfers the memory and the accumulator to the adder which performs a binary "Exclusive OR" on a bit-by-bit basis and stores the result in the accumulator.

This instruction affects the accumulator; sets the zero flag if the result in the accumulator is zero, otherwise resets the zero flag; sets the negative flag if the result in the accumulator has bit seven on, otherwise resets the negative flag.

### **SEC: Set Carry Flag**

This instruction initializes the carry flag to a one. This operation should normally precede a SBC loop. It is also useful when used with a ROL instruction to initialize a bit in memory to a one.

This instruction affects no registers in the microprocessor and no flags other than the carry flag which is set.

### **CLC: Clear Carry Flag**

This instruction initializes the carry flag to a zero. This operation should normally precede an ADC loop. It is also useful when used with a ROL instruction to clear a bit in memory.

This instruction affects no registers in the microprocessor and



---

no flags other than the carry flag which is reset.

**SEI: Set Interrupt Disable**

This instruction initializes the interrupt disable to a one. It is used to mask interrupt requests during system reset operations and during interrupt commands.

It affects no registers in the microprocessor and no flags other than the interrupt disable which is set.

**CLI: Clear Interrupt Disable**

This instruction initializes the interrupt disable to a zero. This allows the microprocessor to receive interrupts.

It affects no registers in the microprocessor and no flags other than the interrupt disable which is cleared.

**SED: Set Decimal Mode**

This instruction sets the decimal mode flag D to a one. This makes all subsequent ADC and SBC instructions operate as a decimal arithmetic operation.

SED affects no registers in the microprocessor and no flags other than the decimal mode which is set to a one.

**CLD: Clear Decimal Mode**

This instruction sets the decimal mode flag to a zero. This causes all subsequent ADC and SBC instructions to operate as simple binary operations.

CLD affects no registers in the microprocessor and no flags other than the decimal mode flag which is set to a zero.

**CLV: Clear Overflow Flag**

This instruction clears the overflow flag to a zero. This command is used in conjunction with the set overflow pin which can change the

state of the overflow flag with an external signal.

CLV affects no registers in the microprocessor and no flags other than the overflow flag which is set to a zero.

**JMP: Jump to New Location**

In this instruction, the data from the memory location located in the program sequence after the OP CODE is loaded into the low order byte of the program counter (PCL) and the data from the next memory location after that is loaded into the high order byte of the program counter (PCH).

The JMP instruction affects no flags and only PCL and PCH. Although the jump allows the change of program sequence, it does so without performing any test. So it is a JMP instruction that is employed when it is desired to change the program counter no matter what conditions have occurred.

**BMI: Branch on Result Minus**

This instruction takes the conditional branch if the N bit is set.

BMI does not affect any of the flags or any other part of the machine other than the program counter and then only if the N bit is on.

**BPL: Branch on Result Plus**

This instruction is the complementary branch to branch on result minus. It is a conditional branch which takes the branch when the N bit is reset (0). BPL is used to test if the previous result bit seven was off (0) and branch on result minus is used to determine if the previous result was minus or bit seven was on (1).

The instruction affects no flags

or other registers other than the P counter and only affects the P counter when the N bit is reset.

**BCC: Branch on Carry Clear**

This instruction tests the state of the carry bit and takes a conditional branch if the carry bit is reset.

It affects no flags or registers other than the program counter and then only if the C flag is not on.

**BCS: Branch on Carry Set**

This instruction takes the conditional branch if the carry flag is on.

BCS does not affect any of the flags or registers except for the program counter and only then if the carry flag is on.

**BEQ: Branch on Result Zero**

This instruction could also be called "Branch on Equal." It takes a conditional branch whenever the Z flag is on or the previous result is equal to zero.

BEQ does not affect any of the flags or registers other than the program counter and only then when the Z flag is set.

**BNE: Branch on Result Not Zero**

This instruction could also be called "Branch on Not Equal." It tests the Z flag and takes the conditional branch if the Z flag is not on, indicating that the previous result was not zero.

BNE does not affect any of the flags or registers other than the program counter and only then if the Z flag is reset.

**BVS: Branch on Overflow Set**

This instruction tests the V flag and takes the conditional branch if V is on.

---



---

BVS does not affect any flags or registers other than the program counter and only when the overflow flag is set.

### **BVC: Branch on Overflow Clear**

This instruction tests the status of the V flag and takes the conditional branch if the flag is not set.

BVC does not affect any of the flags and registers other than the program counter and only when the overflow flag is reset.

### **CMP: Compare Memory and Accumulator**

This instruction subtracts the contents of memory from the contents of the accumulator.

The use of the CMP affects the following flags: Z flag is set on an equal comparison, reset otherwise; the N flag is set or reset by the result bit seven, the carry flag is set when the value in memory is less than or equal to the accumulator, reset when it is greater than the accumulator. The accumulator is not affected.

The purpose of the compare instruction is to allow the user to compare a value in memory to the accumulator without changing the value of the accumulator.

### **BIT: Test Bits in Memory with Accumulator**

This instruction performs an AND between a memory location and the accumulator but does not store the result of the AND into the accumulator.

The bit instruction affects the N flag with N being set to the value of bit seven of the memory being tested, the V flag with V being set equal to bit six of the memory being tested and Z being set by the result of the AND operation

between the accumulator and the memory if the result is zero. Z is reset otherwise. It does not affect the accumulator.

### **LDX: Load Index Register X From Memory**

Load the index register X from memory.

LDX does not affect the C or V flags; sets Z if the value loaded was zero, otherwise resets it; sets N if the value loaded in bit seven is a one; otherwise N is reset, and affects only the X register.

### **LDY: Load Index Register Y From Memory**

Load the index register Y from memory.

LDY does not affect the C or V flags, sets the N flag if the value loaded in bit seven is a one, otherwise resets N, sets Z flag if the loaded value is zero, otherwise resets Z, and only affects the Y register.

### **STX: Store Index Register X in Memory**

Transfers value of X register to addressed memory location.

No flags or registers in the microprocessor are affected by the store operation.

### **STY: Store Index Register Y in Memory**

Transfer the value of the Y register to the addressed memory location. STY does not affect any flags or registers in the microprocessor.

### **INX: Increment Index Register X by One**

Increment X adds one to the current value of the X register. This is an eight-bit increment which does not affect the carry opera-

tion, therefore, if the value of X before the increment was FF, the resulting value is 00. INX does not affect the carry or overflow flags; it sets the N flag if the result of the increment has a one in bit seven, otherwise resets N; sets the Z flag if the result of the increment is zero, otherwise it resets the Z flag. INX does not affect any other register other than the X register.

### **INY: Increment Index Register Y by One**

Increment Y increments or adds one to the current value in the Y register, storing the result in the Y register. As in the case of INX the primary application is to step through a set of values using the Y register. The INY does not affect the carry or overflow flags, sets the N flag if the result of the increment has a one in bit seven, otherwise resets N, sets Z if as a result of the increment the Y register is zero otherwise resets the Z flag.

### **DEX: Decrement Index Register X by One**

This instruction subtracts one from the current value of the index register X and stores the result in the index register X.

DEX does not affect the carry or overflow flag, it sets the N flag if it has bit seven on as a result of the decrement, otherwise it resets the N flag; sets the Z flag if X is a zero as a result of the decrement, otherwise it resets the Z flag.

### **DEY: Decrement Index Register Y by One**

This instruction subtracts one from the current value in the index register Y and stores the result into the index register Y. The result does not affect or consider carry so



---

that the value in the index register Y is decremented to zero and then through zero to FF.

Decrement Y does not affect the carry or overflow flags; if the Y register contains bit seven on as a result of the decrement the N flag is set, otherwise the N flag is reset. If the Y register is zero as a result of the decrement, the Z flag is set otherwise the Z flag is reset. This instruction only affects the index register Y.

NOTE: Decrement of the index registers is the most convenient method of using the index registers as a counter, in that the decrement involves setting the value N on as a result of having passed through zero and sets Z on when the results of the decrement are zero.

### **CPX: Compare Index Register X to Memory**

This instruction subtracts the value of the addressed memory location from the content of index register X using the adder but does not store the result; therefore, its only use is to set the N, Z and C flags to allow for comparison between the index register X and the value in memory.

The CPX instruction does not affect any register in the machine; it also does not affect the overflow flag. It causes the carry to be set on if the absolute value of the index register X is equal to or greater than the data from memory. If the value of the memory is greater than the content of the index register X, carry is reset. If the results of the subtraction contain a bit seven, then the N flag is set, if not, it is reset. If the value in memory is equal to the value in index regis-

ter X, the Z flag is set, otherwise it is reset.

### **CPY: Compare Index Register Y to Memory**

This instruction performs a two's complement subtraction between the index register Y and the specified memory location. The results of the subtraction are not stored anywhere. The instruction is strictly used to set the flags.

CPY affects no registers in the microprocessor and also does not affect the overflow flag. If the value in the index register Y is equal to or greater than the value in the memory, the carry flag will be set, otherwise it will be cleared. If the results of the subtraction contain bit seven on the N bit will be set, otherwise it will be cleared. If the value in the index register Y and the value in the memory are equal, the zero flag will be set, otherwise it will be cleared.

### **TAX: Transfer Accumulator to Index X**

This instruction takes the value from accumulator A and transfers or loads it into the index register X without disturbing the content of the accumulator A.

TAX only affects the index register X, does not affect the carry or overflow flags. The N flag is set if the resultant value in the index register X has bit seven on, otherwise N is reset. The Z bit is set if the content of the register X is zero as a result of the operation, otherwise it is reset.

### **TXA: Transfer Index X to Accumulator**

This instruction moves the value that is in the index register X to the accumulator A without disturbing

the content of the index register X.

TXA does not affect any register other than the accumulator and does not affect the carry or overflow flag. If the result in A has bit seven on, then the N flag is set, otherwise it is reset. If the resultant value in the accumulator is zero, then the Z flag is set, otherwise it is reset.

### **TAY: Transfer Accumulator to Index Y**

This instruction moves the value of the accumulator into index register Y without affecting the accumulator.

TAY instruction only affects the Y register and does not affect either the carry or overflow flags. If the index register Y has bit seven on, then N is set, otherwise it is reset. If the content of the index register Y equals zero as a result of the operation, Z is set on, otherwise it is reset.

### **TYA: Transfer Index Y to Accumulator**

This instruction moves the value that is in the index register Y to accumulator A without disturbing the content of the register Y.

TYA does not affect any other register other than the accumulator and does not affect the carry or overflow flag. If the result in the accumulator A has bit seven on, the N flag is set, otherwise it is reset. If the resultant value in the accumulator A is zero, then the Z flag is set, otherwise it is reset.

Some of the applications of the transfer instructions between accumulator A and index registers X, Y are those when the user wishes to use the index register to access memory locations where there



are multiple byte values between the addresses. In this application a count is loaded into the index register, the index register is transferred to the accumulator, a value such as five, seven, ten, etc., is added immediate to the accumulator and results stored back into the index.

This is known as subroutine nesting and is often encountered in solving complex control equations.

To correctly use the stack for this type of operation requires a jump to subroutine and a return from subroutine instruction.

### **JSR: Jump to Subroutine**

This instruction transfers control of the program counter to a subroutine location but leaves a return pointer on the stack to allow the user to return to perform the next instruction in the main program after the subroutine is complete. To accomplish this, JSR instruction stores the program counter address which points to the last byte of the jump instruction onto the stack using the stack pointer. The stack byte contains the program count high first, followed by program count low. The JSR then transfers the addresses following the jump instruction to the program counter low and the program counter high, thereby directing the program to begin at that new address.

The JSR instruction affects no flags, causes the stack pointer to be decremented by two and substitutes new values into the program counter low and the program counter high.

### **RTS: Return From Subroutine**

This instruction loads the pro-

gram count low and program count high from the stack into the program counter and increments the program counter so that it points to the instruction following the JSR. The stack pointer is adjusted by incrementing it twice.

The RTS instruction does not affect any flags and affects only PCL and PCH.

### **PHA: Push Accumulator on Stack**

This instruction transfers the current value of the accumulator to the next location on the stack, automatically decrementing the stack to point to the next empty location.

The Push A instruction only affects the stack pointer register which is decremented by one as a result of the operation. It affects no flags.

### **PLA: Pull Accumulator From Stack**

This instruction adds one to the current value of the stack pointer and uses it to address the stack and loads the contents of the stack into the A register.

The PLA instruction does not affect the carry or overflow flags. It sets N if the bit seven is on in accumulator A as a result of instructions, otherwise it is reset. If accumulator A is zero as a result of the PLA, then the Z flag is set, otherwise it is reset. The PLA instruction changes content of the accumulator A to the contents of the memory location at stack register plus one and also increments the stack register.

### **TXS: Transfer Index X to Stack Pointer**

This instruction transfers the

value in the index register X to the stack pointer.

TXS changes only the stack pointer, making it equal to the content of the index register X. It does not affect any of the flags.

### **TSX: Transfer Stack Pointer to Index X**

This instruction transfers the value in the stack pointer to the index register X.

TSX does not affect the carry or overflow flags. It sets N if bit seven is on in index X as a result of the instruction, otherwise it is reset. If index X is zero as a result of the TSX, the Z flag is set, otherwise it is reset. TSX changes the value of index X, making it equal to the content of the stack pointer.

### **PHP: Push Processor Status on Stack**

This instruction transfers the contents of the processor status register unchanged to the stack, as governed by the stack pointer.

The PHP instruction affects no registers or flags in the microprocessor.

### **PLP: Pull Processor Status From Stack**

This instruction transfers the next value on the stack to the processor status register, thereby changing all of the flags and setting the mode switches to the values from the stack.

The PLP instruction affects no registers in the processor other than the status register. This instruction could affect all flags in the status register.

### **RTI: Return From Interrupt**

This instruction transfers from the stack into the microprocessor the processor status and the pro-



gram counter location for the instruction which was interrupted. By virtue of the interrupt having stored this data before executing the instruction and the fact that the RTI reinitializes the microprocessor to the same state as when it was interrupted, the combination of interrupt plus RTI allows truly reentrant coding.

The RTI instruction reinitializes all flags to the position they were at the time the interrupt was taken and sets the program counter back to its pre-interrupt state. It affects no other registers in the microprocessor.

### **BRK: Break Command**

The break command causes the microprocessor to go through an interrupt sequence under program control. This means that the program counter of the second byte after the BRK is automatically stored on the stack along with the processor status at the beginning of the break instruction. The microprocessor then transfers control to the interrupt vector.

Other than changing the program counter, the break instruction changes no values in either the registers or the flags.

### **LSR: Logical Shift Right**

This instruction shifts either the accumulator or a specified memory location one bit to the right, with the higher bit of the result always being set to zero, and the low bit which is shifted out of the field being stored in the carry flag.

The shift right instruction either affects the accumulator by shifting it right one or is a read/modify/write instruction which changes a specified memory location but

does not affect any internal registers. The shift right does not affect the overflow flag. The N flag is always reset. The Z flag is set if the result of the shift is zero and reset otherwise. The carry is set equal to bit zero of the input.

### **ASL: Arithmetic Shift Left**

The shift left instruction shifts either the accumulator or the address memory location one bit to the left, with the bit zero always being set to zero and the bit seven output always being contained in the carry flag. ASL either shifts the accumulator left one bit or is a read/modify/write instruction that affects only memory.

The instruction does not affect the overflow bit, sets N equal to the result bit seven (bit six in the input), sets Z flag if the result is equal to zero, otherwise resets Z and stores the input bit seven in the carry flag.

### **ROL: Rotate Left**

The rotate left instruction shifts either the accumulator or addressed memory left one bit, with the input carry being stored in bit zero and with the input bit seven being stored in the carry flags.

The ROL instruction either shifts the accumulator left one bit and stores the carry in accumulator bit zero or does not affect the internal registers at all. The ROL instruction sets carry equal to the input bit seven, sets N equal to the input bit six, sets the Z flag if the result of the rotate is zero, otherwise it resets Z and does not affect the overflow flag at all.

### **ROR: Rotate Right**

The rotate right instruction shifts either the accumulator or ad-

dressed memory right one bit with bit zero shifted into the carry and carry shifted into bit seven.

The ROR instruction either shifts the accumulator right one bit and stores the carry in accumulator bit seven or does not affect the internal registers at all. The ROR instruction sets carry equal to input bit zero, sets N equal to the input carry and sets the Z flag if the result of the rotate is zero; otherwise it resets Z and does not affect the overflow flag at all.

### **INC: Increment Memory by One**

This instruction adds one to the contents of the addressed memory location.

The increment memory instruction does not affect any internal registers and does not affect the carry or overflow flags. If bit seven is on as the result of the increment, N is set, otherwise it is reset; if the increment causes the result to become zero, the Z flag is set on, otherwise it is reset.

### **DEC: Decrement Memory by One**

This instruction subtracts one, in two's complement, from the contents of the addressed memory location.

The decrement instruction does not affect any internal register in the microprocessor. It does not affect the carry or overflow flags. If bit seven is on as a result of the decrement, then the N flag is set, otherwise it is reset. If the result of the decrement is zero, the Z flag is set, otherwise it is reset. **C**



## Easy Spell 64

Reviewed by Mark Cornacchio

*A spelling program you can use with Commodore's Easy Script 64 word processor.*

I don't know about you, but I am a bad speller and typist. I am lazy, too. Therefore, *Easy Spell* is perfect for me.

What is *Easy Spell*? *Easy Spell* is the spelling package made to work with *Easy Script*, the word processing software for the Commodore 64. *Easy Spell* does what the name implies: it checks spelling of files created by *Easy Script*.

*Easy Spell* is loaded directly from *Easy Script* in the same manner a text file is loaded. Once it is loaded, press any key to get the options menu. There are seven options. The first option is entitled "Check Text File". This option checks the spelling of the requested text file. *Easy Spell* will highlight unrecognized words. The qualification for an unrecognized word is a word that is not in the *Easy Spell* Master Dictionary or User Dictionary. To correct spelling mistakes once they are found, use the editing procedures normally used in *Easy Script*. Sometimes it is desirable not to change the unrecognized word. Press the "F1" function key to ignore unrecognized words.

Options three through five let one print, delete and search dictionaries. The print and delete options only apply to the User Dictionary. But before discussing

the User Dictionary, I would like to discuss the Master Dictionary. The Master Dictionary has 20,000 words. The Master Dictionary cannot be altered. Parts of the dictionary can be seen by using the search option. Pattern matching helps search the Master Dictionary quickly. Now! What we all have been waiting for—a word about the User Dictionary. *Easy Spell* may produce an unrecognized word that is actually spelled correctly. To prevent this from happening in the future, add the word to the User Dictionary. To add a word to the User Dictionary, simply press the left arrow key.

This software is a must for anybody who owns *Easy Script*. *Easy Spell* enhances *Easy Script* so immensely, in my opinion, that it makes *Easy Script* the best word processing package on the market for the Commodore 64. In addition to the features mentioned above, *Easy Spell* can "learn" words while correcting text. The manual has more information on "learned words". *Easy Spell* is a time saver, and in business time is money.

### COMPUSETTE

AT WHOLESALE **Only** PRICES \*44¢ ea



100% Error-Free & Fully Guaranteed

QTY:	12	24	96	250*
C-05	.69	.59	.49	.44
C-10	.79	.69	.59	.49
C-15	.89	.79	.69	.59
C-20	.99	.89	.79	.69
Boxes	.26	.21	.20	.16



NEW Pin-fed Labels 200/1499



Tape Caddy Only \$2.75 Holds 12 Tapes

Shipping & Handling (UPS Brown Label)  
(12-24) \$3.95 (36-96) \$6.95 (250) \$12.95 Misc Items \$1.00 ea

\$10.00 Minimum Order  
SAME DAY PROCESSING  
**Order Toll-Free**  
ORDERS ONLY 1-800-553-0035 Ext 80  
1-800-528-6050 Ext 3005

MasterCard Information & Inquiries 1-206-675-6143 VISA

### Micro-80™ INC.

2665 C Busby Road  
Oak Harbor, Wash., 98277

## PEEK

FULL FEATURE MAGAZINE  
on  
CASSETTE  
FOR THE  
VIC 20™ and COMMODORE 64™

- GAMES
- EDUCATION
- REVIEWS
- TUTORIALS
- BUSINESS
- UTILITIES

• READY TO RUN PROGRAMS •

1 YEAR (12 issues) . . . \$49.95  
6 MOS. (6 issues) . . . \$28.95  
1 TRIAL ISSUE . . . . . \$8.50

subscribe today

PEEK MAGAZINE  
4145 BROOKSIDE BLVD.  
CLEVELAND, OHIO 44135

VIC 20™ and COMMODORE 64™ is a  
trademark of Commodore Electronics Ltd.

poke into peek  
MAGAZINE



# Creating and Photographing Graphic Displays

by Brooks Cooley

Since the beginning of time man has had the desire to express himself. Early man left sketches and paintings on cave walls that told of life as it was. Today, man still has that innate desire of early ancestors, but over the centuries has developed a highly advanced medium in which to work. Modern advances have led to high-resolution bit-mapped graphics where images are drawn on a graphics pad, digitized, and stored on a disk for later recall. Computers and graphics pads are today what plant dyes and cave walls were to our early ancestors.

Computer graphics pads have replaced the paper sketch pad of many doodlers as well as serious artists. The ease and speed at which highly detailed displays can be created has astonished many and received the praise of all. No longer is it necessary to spend many hours with pencil and graph paper plotting individual pixel colors. With the aid of a graphics pad, a user can now create in minutes what would have before taken days.

Graphic enhancement peripherals can vary from light pens to touch-sensitive surfaces. Most graphics pads, for example, contain pressure sensitive films that, when touched, send electronic signals to the computer. The pressure of a stylus causes the pad's two voltage-resistant films to come into contact. This determines two distinct voltages, which are sent to an encoding circuit within the graphics pad. An analog-

to-digital converter changes these voltages into digital signals. These signals are sent through a control port to, believe it or not, the Commodore 64 SID chip. The SID chip decodes the signals and stores the corresponding values in the appropriate memory locations. The software supporting the graphics pad is now able to determine the X and Y coordinates where the pressure-sensitive film plates came into contact. This process is extremely fast and transparent to the user.

The photographs shown are high resolution displays created on the Commodore 64 with the aid of a graphics pad. Each display was completed in less than one hour! Anyone can easily create computer graphics such as these, and you don't have to be a programmer or an artist. The graphics pad has a vast number of applications bounded only by our imaginations.

After you have completed a display, you may want to photograph it. You will need a camera that allows you to photograph subjects within 1.5 feet, a tripod, film and a dark room. If a dark room is not available, a hood can be made from any dark, colored material that doesn't let light in. Before taking the photograph, remember to turn off the lights or cover the monitor and camera with the hood in such a way that keeps light from leaking in. This will prevent reflections from showing up in the photograph. If you are using the hood, be careful not to get it in the camera's field of view.

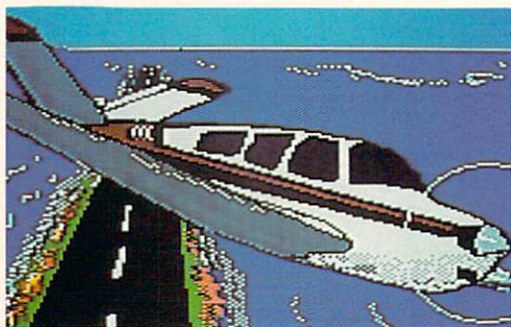
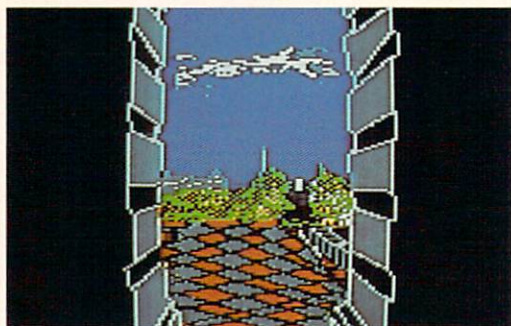



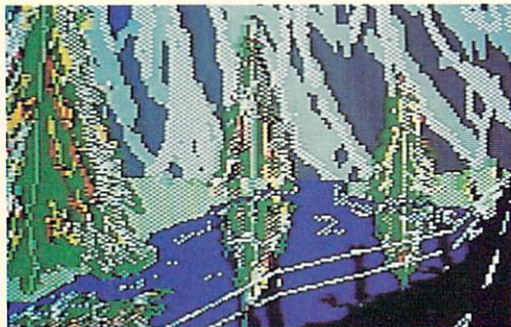

Depending on the camera used, you may have to experiment with different combinations of shutter speeds, screen brightness, and f stops. I have obtained the best results with Kodak Kodacolor II 100 ASA or Kodacolor VR 100 film at f stop 8 with an exposure of one second. A flash should not be used when photographing your displays. If color slides are preferred, substitute Kodak Ektachrome 64 slide film for the print film. When all of the exposures have been made, the film can be taken to any local Kodak film developer for processing.

If you think you have created an exceptional display, please send us a copy of your print or slide. Also include a short description of how you photographed it, your name, address and how long it took you to create the display. Commodore is looking forward to publishing the best photographs received. For more information about graphics pads, contact your local Commodore dealer and start your masterpiece today.

Send your photographs or slides to:

Commodore Business  
Machines, Inc.,  
Computer Graphics Software  
Division  
1200 Wilson Drive  
West Chester, PA 19380

All photographs and slides are nonreturnable and become the property of Commodore. **C**

**'PUBLIC DOMAIN'<sup>™</sup>  
— SOFTWARE —**

Supporting all COMMODORE computers  
Written by users, for users  
★ GAMES ★ UTILITIES ★ EDUCATIONAL ★

**VIC 20<sup>™</sup>**

collection #1 — collection #2 — collection #3  
collection #4 — collection #5 — collection #6  
70+ programs per collection — Tape/Disk — \$10.00

**COMMODORE 64<sup>™</sup>**

64 collection #1 — 64 collection #2 — 64 collection #3  
64 collection #4 — 64 collection #5  
25+ programs per collection — Tape/Disk — \$10.00

**PET<sup>®</sup> / CBM<sup>®</sup>**

5 Utility — Tapes/Disks — \$10.00 each  
11 Game — Tapes/Disks — \$10.00 each  
6 Educational — Tapes/Disks — \$10.00 each

All prices include shipping and handling.  
**CHECK, MONEY ORDERS,  
VISA and MASTERCARD accepted.**

For A Free Catalog Write:

**Public Domain, Inc.**

5025 S. Rangeline Rd., W. Milton, OH 45383  
10:00 a.m. — 5:00 p.m. EST — Mon. thru Fri.  
(513) 698-5638 or (513) 339-1725

VIC 20<sup>™</sup>, CBM<sup>®</sup> and Commodore 64<sup>™</sup> are Trademarks of Commodore Electronics Ltd.  
PET<sup>™</sup> is a Registered Trademark of Commodore Business Machines, Inc.

**ATTENTION**

**SUPERPET<sup>™</sup> OWNERS**

\*\*\*\*\*  
Quality Data Services  
announces

**COM-MASTER**

-----  
An ADM-3A<sup>™</sup> emulator for the SuperPET's  
6809 processor, which also includes  
the following features:

- \* Buffered, interrupt-driven input and output at baud rates from 50 to 19200
- \* ASCII control codes via use of the OFF/RVS key as a control key
- \* Software handshaking optional on either input, output, or both
- \* Transmit or receive disk files through the serial port
- \* ASCII or APL character sets
- \* plus many other useful capabilities

ALL FOR \$95 PER LICENSED COPY  
(includes tax and First Class U.S. Mail)

Send check or money order to:

QUALITY DATA SERVICES  
2847 Wai'alae Ave., Suite 104  
Honolulu, HI 96826

Telephone: (808) 735-1202

DEALER INQUIRIES INVITED

SuperPET is a trademark of  
Commodore Electronics Ltd.

ADM-3A is a trademark of  
Lear-Siegler, Inc.



## On the Merits of Touching Up the X-Rays

by Elizabeth Deal

*To structure or not to structure is a hot programming question.*

A man went to his doctor to find out why he had been suffering terrible pain. After some tests he was told that the X-ray revealed a serious condition that needed surgery. The man asked how much it would cost. "About ten thousand dollars," the doctor replied. The man said, "Doctor, I can't afford that kind of treatment. I am poor and have no health insurance. What can you do for me for fifty dollars?" The doctor thought about this for a few minutes and said: "Well, I could touch up these X-rays."

### Structured Programming

A common description of "structured programming" is one that says, "You can indent lines of code and it has no GOTO statements". That's technically correct of course, but is only partly true. I think it steers beginners onto a totally wrong course.

Several months ago I saw just such a description of structured programming in a major computer magazine and I wondered then how much damage it could do. Now I know.

Recently I saw a paper for educators that encouraged them to teach structured programming. For pages and pages it extolled the virtues of structured programming. It described our normal programming efforts as being a "rat's nest of branches, full of illogical thinking" and other such unpardonable sins. Among other things, this paper showed an example of unstructured coding. The program had many GOTOs, with branches crossing all over the place, like this:

```
100...
110 IF PLUS GOTO 200
120 IF MINUS GOTO 300
150 GOTO 400
200 A=A+B: GOTO 400
300 A=A-B: GOTO 400
400 GOTO 100
410...
```

To cure the problem and to demonstrate the power of structuring, the paper proceeded to draw a structured flowchart, whatever that is. Branches that crossed over were neatly replaced by little circles or "termination points" as in Figure 1.

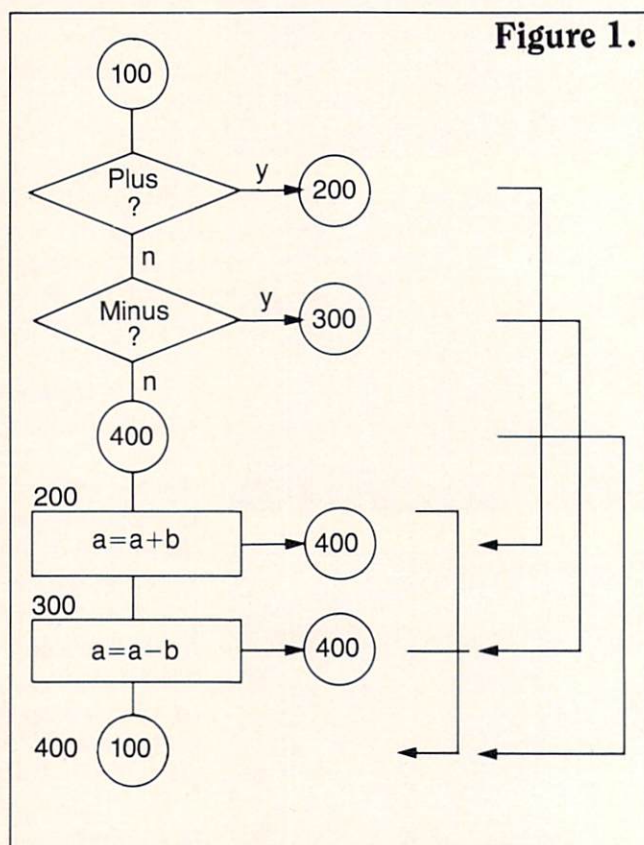

To complete the job and to compound the confusion, most GOTO statements were carefully replaced by THEN so the program now read:

```
100...
110 IF PLUS THEN 200
120 IF MINUS THEN 300
130 and so on
```

The parting conclusion of this effort was, "We now have a GOTO-less structured program".

In my humble opinion we now have *nothing*.



Replacing GOTO by THEN, a statement that does the same thing only slower, and replacing crossing branches by terminator points is as useful as touching up the X-rays: the mess is still there.

Clearly, this paper missed the point of structuring entirely, which has to do with seeing a large task as a collection of small, perhaps already solved, steps; with desirability of coding tiny units which can be easily debugged; with using flags, the condition of the machine, as a basis for decisions; with using arrays or subroutines in general; with nesting of loops and branches if such must exist, and so on. Instead, the paper played a semantic, substitute-the-keywords, game, never offering simple code such as:

```
100...
110 IF PLUS THEN A=A+B
120 IF MINUS THEN A=A-B
130 GOTO 100
```

which can be cut neater by some Boolean functions anyway. Its uncluttered flowchart could have been the one shown in Figure 2.

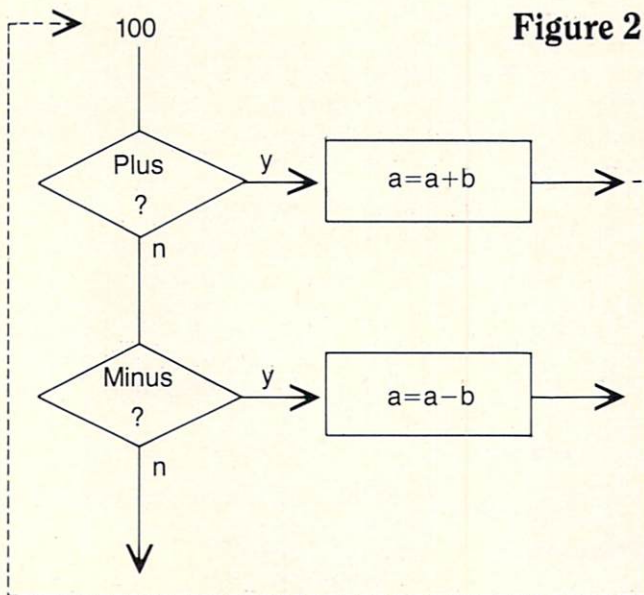

Figure 2.

I do not really intend to take part in or describe the raging debate over structuring, but the concepts of real structured programming are worth knowing indeed. The following are excellent sources, if you're interested in what all the fuss is about:

- (1) Various papers by Bohm and Jacopini, Dijkstra and others in the field are available in many libraries.
- (2) Paul Nagin and Henry Ledgard, *BASIC With Style: Programming Proverbs*, Hayden Book Company, 1978.
- (3) Brian W. Kernighan, P. J. Plauger (Bell Labs, Inc.), *The Elements of Programming Style*, McGraw Hill Book Company, 1974.
- (4) Seymour Papert, *Mindstorms: Children, Computers, and Powerful Ideas*, Basic Books, 1980.

### BASIC Perspective

BASIC, or machine code for that matter, is difficult to do without branches (GOTOs), but many can be eliminated if we follow this pragmatic principle: code GOSUB when you can, code GOTO if you must.

But keep in mind that this is only a part of the structuring story. While an apparent goal of structuring is reducing unnecessary GOTO statements, the thought behind the exercise is a better program organization for the purpose of readability and easier maintenance in the future. As the code is being reorganized, many GOTOs vanish from sight without any conscious effort. So, in a sense, it sometimes becomes a circular process of one thing helping another, an interesting process indeed.

I often wonder if the structuring fanatics haven't dug their own grave by having overshadowed their sensible campaign for orderly, logical program design with their loud anti-GOTO pronouncements. It leaves the audience with a misleading impression that the entire debate turns on the presence or absence of GOTO and GOTO alone... and we end up with keyword substitution as a cure.

### Debugging Troubles

It has crept up slowly, but I began to notice recently that many programmers are abandoning GOTO. I've seen a lot of THEN123 type coding,



# programmer's tips

and began to wonder why. It's a nasty, inconvenient little switch in style. BASIC-Aid type of utilities, which help search through a program, become difficult to use.

When a program contains GOTOs, and you are interested in "transfer of control" to know if somebody's line 100 is a GOTO/GOSUB target, this type of utility can easily plop all the simple GOTOs on the screen.

But when GOTO100 is coded as THEN100, we're in a terrible predicament of having to weed out genuine THEN-action (as in THEN V=15:K=1) from THEN-line number. Often a program contains so many THEN-action statements that zeroing in

on THEN-line numbers becomes an unnecessarily tedious task. Frankly, I fail to see a reason for ever substituting THEN for GOTO. *Please, do not touch up the X-rays!*

I think it's most convenient to code THEN for a process to happen and to code GOTO for transfer to another place in a program. The computer doesn't care, but it can make work much simpler for us. **C**

## EXPANDER BOARDS CBM 64™

**IMPROVED**

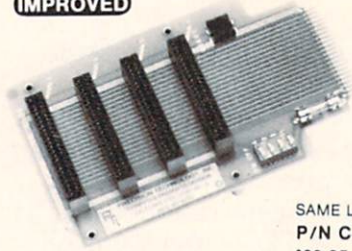

**4-SLOT**  
Newly designed unit with solid-state switching on the GAME and XROM lines for universal compatibility with all cartridges. Normal computer operation is unaffected by cartridges left plugged in.

SAME LOW PRICE  
P/N C-64  
\$69.95

## VIC 20™

**REDUCED**

**6-SLOT**  
Toggles, fuse and reset  
P/N V-36  
\$69.95

**6-SLOT** with  
3-ft. ribbon cable  
P/N V-46  
\$89.95

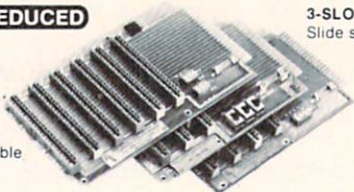

**3-SLOT**  
Slide switches and fuse  
P/N V-23  
\$49.95

**4-SLOT**  
Toggles, fuse and reset  
P/N V-24  
\$59.95

All expanders feature fiberglass circuit boards with epoxy solder mask, gold contacts and metal feet.

## MONITOR/AUDIO CABLE

Connects VIC 20 or CBM 64 to audio amplifier and TV monitor

**PRECISION TECHNOLOGY, INC.**  
COMPUTER PRODUCTS DIVISION  
P.O. BOX 15454  
SALT LAKE CITY, UTAH 84115  
(801) 487-6266

Color 64 or VIC P/N MC-2 \$12.95  
B & W 64 only P/N MC-3 \$12.95

See your dealer or place your order directly

VISA - M/C - CHECK - COD

TM-Trademark of Commodore Electronics Limited

# TaxQwik®

TaxQwik, the proven software package used by professional tax preparers is now available to you. Designed for your personal Commodore 64,™ TaxQwik performs income averaging comparisons, calculates expenses for moving, business and child care and determines home energy credits.

TaxQwik is a well documented, easy-to-use, tax preparation system and, best of all, TaxQwik is tax deductible.

Available in 2 versions:

Version I  
1040  
Schedule A,B,G,W,  
\$59.95

Version II  
1040  
Schedule A,B,C,D,G,SE,W  
Numbered Forms 3093,  
2106, 2441, 5695  
\$99.95

For more details call:



**GENEVA TECHNOLOGIES CORP.**  
225 Christiani St.  
Cranford, NJ 07016  
(201) 276-1144

TaxQwik® is a Registered Trademark of Geneva Technologies Corp.  
Commodore 64 is a Trademark of Commodore Business Machines, Inc.



# Random Thoughts

## Part 3: Moment by Moment

by Mark Zimmermann

Last time, we talked about "discrete" distributions of random numbers, that is, distributions that have only a finite, countable number of possible outcomes. In principle you could solve any random number problem as accurately as you pleased using discrete distributions. But in practice it might get very inconvenient and time consuming to do so.

For example, suppose you're studying some simple biological system that has various properties, determined by the sum of the influences of a number of genes. The basic blood type, for instance, might be O, A, B, or AB, depending on only two genes. With so few choices to consider, you can easily work out all the possible cases using discrete probability arguments. But suppose there are 1000 genes that affect some biological property? How can you possibly count up all the possible outcomes?

The answer is: don't try! Instead, think about the possible outcomes as a continuous, smoothly varying set of possibilities, and ask how likely it is to come out in any given range of results. To get a precise answer in some complicated cases may require a little advanced mathematics. But most of the time you can go a long way using only a few simple rules, which we'll cover in this and in future columns.

### Mind the P's and Q's

To discuss the continuous distributions that we're interested in, we need a way to talk about the quantitative differences between different distributions. A good way to begin is by defining the "moment" of a distribution. If  $X$  is the name of the random number we're concerned with and it has some probability distribution we'll call  $P$ , then we can define the "Nth moment of the distribution  $P$ " as the average value of  $X^N$ .

That definition may not make much sense yet, so let's explore it for a little while. First, for a continuous random variable  $X$ , what exactly does a "probability distribution  $P$ " mean? Answer:  $P$  is a function of  $X$  (you can write it as  $P(X)$  if you like, and read it as "P of X") which is always positive (or zero) and which describes the chance that  $X$  assumes some particular value. For example, look at the graph

in Figure 1.

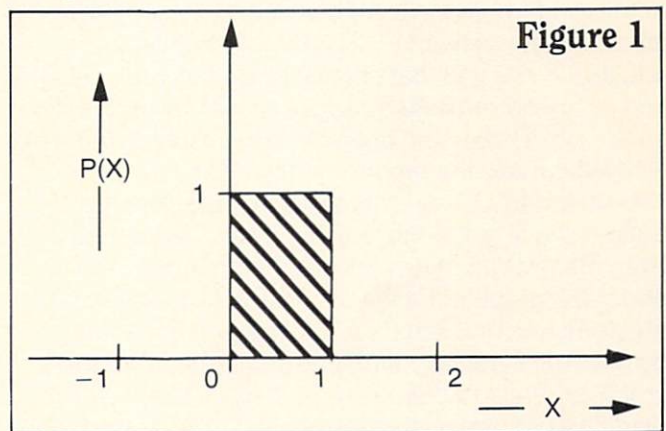

As you can see, we've plotted the value of  $P$  along a vertical axis, with  $X$  running horizontally.  $P(X)$  is zero everywhere except between  $X=0$  and  $X=1$ , where  $P(X)=1$ . This choice of  $P(X)$  just says that  $X$  has zero probability of being chosen randomly if  $X$  is less than zero or  $X$  is greater than one. On the other hand, any value of  $X$  between zero and one is equally likely to be picked. So the function ("continuous distribution")  $P(X)$  graphed in Figure 1 is precisely the  $RND(1)$  function of standard BASIC in your computer!

A slightly more complicated probability distribution, called  $Q(X)$ , is graphed in Figure 2, to help you get the idea even clearer.

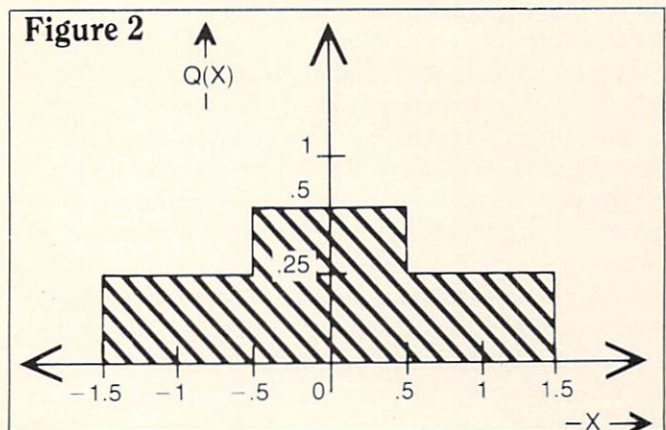



As you can see, if  $Q(X)$  describes the distribution of the random variable  $X$ , then  $X$  is equally likely to fall anywhere between  $-.5$  and  $+.5$ . However, in addition  $X$  has half that chance to fall between  $-1.5$  and  $-.5$ , and similarly a chance to fall between  $+.5$  and  $+1.5$ . There is no chance (zero probability) for  $X$  to fall outside the range  $-1.5$  to  $+1.5$ .

Both  $P$  and  $Q$  are pretty simple probability distributions; we'll get to more complicated examples later. Meanwhile, notice please that the total area under the graph of  $P$  (shaded in Figure 1) adds up to precisely one unit squared. It's one unit horizontally by one unit vertically. Similarly, the area under the graph of  $Q$  also adds up to one square unit. It's made up of three rectangles of areas  $.25$ ,  $.5$ , and  $.25$  respectively, which adds up to one again. The fact that the areas under the graphs are one is no coincidence. It's a basic fact of probability that  $X$  has to take on *some* value, for certain, and a thing that is certain has probability one.

So what I'm trying to say is that the *area* under the graph of a continuous probability distribution adds up to the total chance that the random variable falls into that range along the horizontal axis of the graph. The chance that the variable  $X$  when distributed according to probability distribution  $P(X)$  falls between zero and one is probability one (certainty), since the area of  $P$ 's graph between zero and one is one square unit. The chance that  $X$  falls between zero and  $.5$  if governed by  $P$ , is  $.5$ , that is, the area under the graph of  $P$  above the  $X$  axis between  $X=0$  and  $X=.5$ .

In the slightly more complex case of the distribution  $Q(X)$ , the chance of finding  $X$  between  $-.5$  and  $.5$  adds up to  $.5$ , the area under the graph of  $Q$  for that range of  $X$  values. What is the chance of finding  $X$  between  $-1$  and zero? Well it's half of the rectangle in  $Q$ 's graph between  $-1.5$  and  $-.5$ , plus half of the rectangle between  $-.5$  and  $.5$ —a total of  $\frac{1}{2} \cdot .25 + \frac{1}{2} \cdot .5$ , which equals  $.375$  (or  $\frac{3}{8}$ ). For a final example, the chance of finding  $X$  between  $1.0$  and  $1.1$  when  $X$  is controlled by distribution  $Q$  is the area in that zone  $0.1 \cdot .25 = .025$ —a pretty small chance.

## One Moment, Please

Ok, now let's return to exploring the definition of the "moments" of a distribution. What are some specific cases?

Plugging  $N=1$  into the definition, we read that the "first moment" of a probability distribution is the average value of  $X^1$ , that is, simply the average value of  $X$ . Much ado about nothing!? Not at all. The average value of a random variable  $X$  is probably one of the first things we should know and keep in mind when thinking about it. For our distribution  $P(X)$  from Figure 1, where  $X$  is equally likely to fall anywhere between zero and one, the average outcome is exactly  $.5$ . For random variables governed by  $Q$  in Figure 2, you can guess by symmetry that the average result is zero (since it's equally likely to be positive or negative, and zero is the only number that fits both requirements).

If you study the graphs of the random distributions  $P$  and  $Q$ , and think about the areas under the graphs as physical objects (such as you'd get by graphing onto thick paper and cutting out the shaded areas), you'll find another meaning of the first moment of a distribution. The first moment corresponds to the center of gravity (or center of mass, if you prefer) of the cutout graph, along the  $X$  axis. If you have a complicated distribution and it's not obvious what the average value is, a legitimate way to determine the average (approximately) is to graph the distribution, cut it out and balance it!

## Moment Two

On to the second moment: the average value of  $X$  squared. What good is that? Well for starters, consider the special case where the first moment was zero (as it was for  $Q$  in Figure 2). That first moment came out zero because there was as much plus as there was minus in the numbers adding up to give the average outcome of  $X$ . But if we're averaging the values of  $X^2$ , then all of the inputs to the average will be positive, since squaring the negative numbers makes them positive. Note: be sure to square *before* adding up and averaging.

Now squaring a number, as discussed in an earlier column, makes for a funny non-linear stretching of



values. Numbers near zero get smaller when squared, but numbers greater than one get bigger. So the second moment, the average of the squares of the random outcomes, is a "weighted average" that gives more weight to bigger numbers than it does to numbers near zero. In fact, the second moment tells you a lot about *how wide* a random distribution is: the wider the distribution, the bigger the second moment tends to be.

The second moment, in fact, is used to define the "variance" and the "standard deviation" of a random variable about its average value. The variance, call it  $V$ , is just the difference between the second moment and the square of the first moment. The standard deviation, call it  $S$ , is the square root of the variance. Just looking at the dimensions of the things, the definitions make sense. The first moment, the average value of  $X$ , has the same units as  $X$  does. The second moment has units of  $X$  squared. So, subtracting the square of the first moment from the second is dimensionally consistent; you aren't trying to subtract apples from oranges. Taking the square root of the variance gets you back to units of  $X$  for the standard deviation.

Physically, the second moment of a distribution corresponds to the *moment of inertia* of the cut-out graph of the distribution about the vertical axis. That makes sense. A wide, spread-out probability distribution has a large second moment, just as a skater with arms stretched out has a large moment of inertia and spins slower. The terminology "moments of a distribution", in fact, probably arises from this physical meaning of the second moment.

### The Monte Carlo Method

To solidify the concept, let's determine the second moment of our distributions  $P$  and  $Q$ . This is not as trivial an enterprise as finding the first moments, which we could do by inspection. In fact, to get the exact answer without a lot of trickery one probably has to use a little calculus. I'll give you that exact answer, but first we should explore a couple of methods that you can use without calculus to get as accurate a result as you please.

The first method, which has great generality,

is usually called the "Monte Carlo" approach, named after the famous casino. In a Monte Carlo calculation, you simulate a random process by doing a numerical experiment on your computer over and over again until the average result settles down to whatever accuracy you like. Monte Carlo calculations are very popular in complicated situations where an exact computation is too horrendous to think about doing.

Start out with the random distribution  $P(X)$ , which is simply  $RND(1)$  on your computer. To get the second moment, the average value of the random variable  $X^2$ , you might try inputting:

```
A=0: FOR I=1 TO 100: X=RND(1)
:A=A+X*X: NEXT I: PRINT A/100.
```

In a short time, you should see the resulting estimate of the second moment appear on your display. When I first tried it, I got 0.3276; my second try gave 0.3086. If you have the patience, change the number "100" in the one-liner above to a larger value, and you'll get a more accurate average outcome.

### Slicing it Fine

If putting yourself at the mercy of a random number generator makes you uncomfortable, here's another approach to computing the second moment of a distribution. Split the distribution up into a bunch of thin vertical slices, estimate the average value of  $X$  squared in each slice and add up those estimates times the probability of finding  $X$  in each slice. That is, estimate how often  $X$  shows up in each slice you cut and average the estimates of  $X$  squared weighted by the chance of each occurrence. For example, look at the graph of  $P$  in Figure 1. Cut the  $X$  axis up into five slices between  $X=0$  and  $X=1$ , with cuts at  $X=.2, .4, .6$ , and  $.8$ . The chance of finding  $X$  in each of those slices is the area under the graph of  $P$ , namely  $1/5 = 0.2$ . In the first slice, where  $X$  ranges between zero and 0.2, the midpoint value is 0.1, and so a reasonable estimate for the average value of  $X^2$  is  $0.1^2 = 0.01$ . Similarly, if you pick the midpoint of each thin slice and square it to estimate the average of  $X$  squared in that slice, you come up with the five estimates for the five slices:



0.01, 0.09, 0.25, 0.49, and 0.81. Multiplying each number by the chance of finding X in that slice and adding up the total, you get the weighted average of 0.33 as your estimate for the second moment of the distribution P.

You could automate this procedure and write a program to do the estimating and adding for you. In fact, you could also work out mathematically the general form of the sum as a function of the number of slices you cut the interval into. If you applied your program (or your analysis of the math) to the case where the number of slices was huge, you'd find that the answer you got for the second moment approached the number 1/3. And, in fact, 1/3 is exactly the answer of the problem. The usual freshman-calculus solution follows this method to the limit where the number of thin slices goes to infinity. But you see that even with as few as five slices, we got the right result to better than two decimal places!

If you want to test yourself by working out the second moment of random distribution Q in Figure 2, you can check your results against the exact answer at the end of this article.

## Other Moments

How about the variance and the standard deviation of distribution P? Well, the variance is the second moment (1/3) minus the square of the first moment (1/2 squared = 1/4) or  $V=1/12$ . The standard deviation is  $SQR(V) = 1/SQR(12) = .288675$ . Roughly speaking, the standard deviation tells you the spread, plus or minus, of a "typical" choice of random numbers about the average value.

What about higher moments of a distribution? They tend to come up less often than the first (average) and second (variance) moments in practical applications but they're still important. The third moment, the average of X cubed, tells you something about the *asymmetry* of the random distribution, the bias about the center toward plus or minus. The fourth moment gives more information about how steeply the distribution falls off at the edges—how rounded it is. And so on.... It's a surprising and marvelous mathematical fact that given all the moments of a distribution, you can deduce what the

distribution looks like. This ability to go backwards from the moments to the graph of the distribution is similar to the way you can analyze any sound into the frequency components that go into it, or analyze a color into the wavelengths of light that made it (using a prism, for example).

One more interesting item to think about: what is the *zeroth* moment of a distribution? By our definition, it is the average value of  $X^0$ , and any number to the zero power is one. The zeroth moment corresponds to the total area under the probability distribution graph and, as we discussed earlier, that area has to add up to one square unit. So, even the zeroth moment has a sensible interpretation.

## The "Square Root" Rule of Thumb

In closing this time let me give you a very useful, approximate rule that helps with random numbers in many situations. I call it the "square root" rule. On the average, the deviation of the sum of a bunch of random numbers goes up proportionally with the square root of the number of numbers added.

So for instance, if you toss a hundred pennies at once, how far from the average value of 50 should you expect the outcome to be? Answer: roughly plus or minus ten, the square root of 100. If you tossed a million pennies, you'd expect the outcome to be 500,000 plus or minus 1,000 since 1,000 is the square root of 1,000,000.

If you do a Monte Carlo experiment for 100 trials (as we did in estimating the second moment of P earlier) and the results of a single trial vary by  $\pm .5$  or so, you'd expect the sum of the hundred trials to vary by ten times that,  $\pm 5$ , and so the average result should vary by  $\pm 5/100 = \pm .05$ . Increasing the number of trials by a factor of 100 should give you one more decimal digit of accuracy in your answer.

This "square root" rule tells you that a political poll of 1000 people is likely to get fluctuations in the responses by  $\pm 30$  or so, that is, roughly  $\pm 3\%$  accuracy. The rule applies to lots of situations.

Meanwhile, the second moment of distribution Q, for those of you who want to know, turns out to be  $7/12 = .583333...$

C



# Using Picture Format A Six Pack +

by F. H. Shedd

The first statement that is sadly missed by the programmer who graduates from one of the higher level languages to the BASIC used by most micro-computers is the lack of a PRINT formatting provision. COBOL has the PICTURE, FORTRAN the FORMAT and others the USING statement. The well detailed programmer's reference guides published by Commodore give information to the gamester who may wish to put a tear in Ms Pacman's eye, but gives little aid to the business programmer trying to align his decimal points when generating an accounting report.

The reader will probably have already deduced that I am an old retired systems analyst who had been accustomed to satisfying accountants who would sometimes look at a printout and imply that it had all the esthetic value of a ransom note. The greatest opportunity for employment in the computing science field lies in business programming. Working there a business programmer who does not visibly accept the fact that computing science is the servant of financial management, not its master, will soon be set right during his first meeting with the comptroller, who in many companies is over the manager of the computing organization. In computerese: if unconvinced then unemployed.

And it might also pop into the reader's mind that I had been accustomed to having access to million-dollar mainframes and that at this time I have a Commodore 64 to keep me happy.

Now, even though I do not have to satisfy others, I cannot put up with sloppy outputs. They are the mark of laziness, ignorance or the professional amateur. Of these ignorance is most easily forgiven for it is the most easily remedied. So one of the first subroutines that I developed, after having solved some of the mysteries of the LEFT, MID and RIGHT handling of a string was to write a short program which furnishes the four most needed formats. It occupies a minimum of RAM and, when compared to some other programs which do less and use more memory, is a miracle of simplicity.

Following is a description of the 7 PICTURES pictures made available by the SUBROUTINE

"V0123456\$" shown as Listing 1. The lower case "s" when appearing in the PICTURE denotes the space reserved for the signum. It is blank for zero and all numbers greater than zero. It contains a dash ("-") for all numbers less than zero. The lower case "b" denotes a blank space.

Instructions 2000 through 2070 allow the user to change output length to satisfy the expected magnitude of input or to fill the space allotted by form design. Do not be too frugal. Remember that input values might be small but their total much greater and the decimal point must still stay in alignment.

Numbers with over eight significant digits are to be avoided when using the 64 for accounting records which must be accurate to the last printed digit. The ninth digit, especially when the product of calculations where repeating decimals are involved, are unreliable. If you like to test this take the square root of 999 and square the result. Note that the value is off three digits in the ninth place. This is the result of the CPU's automatic rounding. When working with numbers such as those that define the distance to the moon, or the National Debt, one requires a "bit" more precision than possessed by the 64.

Although I have never met an accountant who liked to work in cents, if you do have such input just add to the program:

```
2001 V=V/100
```

One last warning about presenting financial reports to an accountant for approval. Never, even as a joke, give him one showing any value in scientific notation. I feel most fortunate that I was at a distance of 20 feet when I witnessed a tragedy of this nature.

If you intend to store these formats in an array and have to be able to restore the V rounded value for future computations you may easily do so using the VAL numeric function for V0\$, V1\$, and V2\$. The \$ sign may even be stripped from V3\$ and then evaluated. However the forms with embedded commas are much more difficult and it is recommended to double-store the value in your array with one in a simple form.



# programmer's tips

- V0\$ — PICTURE s99999999b  
— Length is 10, left justified.  
— Value is identical to V input.  
— Usual use is to record actual (unrounded) V values in an array where constant length record fields are required. Not usually an output FORMAT.
- V1\$ — PICTURE bs99999999  
— Value is V rounded in cents.  
— Length is 10, right justified.  
— Column heading required : VALUE IN CENTS :.  
— Although accountants dislike financial reports having integer cents as output, this FORMAT is sometimes a godsend to the programmer laying out a Financial Spread Sheet with a Title/Identity column, 12 Monthly columns, and a Total Column. With the limit of a 132-character line these 13 extra spaces can come in mighty handy.  
— This is the best FORMAT to save in an array where V may be recovered for later computations by VAL(V1\$)/100.
- V2\$ — PICTURE bs999999.99  
— Length is 11, right justified.  
— Value is V rounded to nearest cent in decimal dollars.  
— Column heading required : VALUE \$ :.  
— V may be recovered using VAL (V2\$)
- V3\$ — PICTURE bs999999.99  
— Length is 12, right justified.  
— Column heading required : VALUE :
- Incorporates floating \$ sign.  
— V may be recovered by using:  
L=LEN(V3\$) : V=VAL  
(RIGHT\$(V3\$,L-1))
- V4\$ — PICTURE b(999,999.99)  
— Length is 13, right justified.  
— Incorporates:  
Embedded commas.  
Signum removed. Negative numbers now with leading and trailing brackets.  
Positive numbers and 0 have leading and trailing blanks.  
— This FORMAT is much favored by accountants. Most dislike dash “—” as a CREDIT indicator.  
— It is generally the only approved FORMAT for use when generating Balance Sheets or Profit and Loss Statements.
- V5\$ — PICTURE b999,999.99 CR  
— Length 14, right justified.  
— Incorporates:  
Embedded commas.  
Negative numbers are suffixed by ‘bCR’.  
Positive and 0 by ‘bbb’ (3 blanks).  
— This FORMAT and V6\$ following are invaluable for Billing or Invoicing Forms where space is not at a premium and the printed value must not be subject to misunderstanding.
- V6\$ — PICTURE b\$999,999.99 CR  
— Length 15, right justified.  
— Same as V5\$ with added floating \$ sign. C

## Listing 1. Subroutine V0123456\$

```
2000 REM** SUBROUTINE  'V0123456$'  
2010 L0=10:REM V0$ JUSTIFIED V  
2020 L1=10:REM V1$ -> 12345678<- ROUNDED  
2030 L2=11:REM V2$ -> 123456.78<- ROUNDED  
2040 L3=12:REM V3$ -> $ 123456.78<- ROUNDED
```



```

2050 L4=13:REM V4$ ->(123,456.78)<- ROUNDED
2060 L5=14:REM V5$ -> 123,456.78 CR<-
2070 L6=15:REM V6$ ->$123,456.78 CR<-
2080 V0$=STR$(V)
2090 L=LEN(V0$):IF L<L0 THEN V0$=V0$+" ":GOTO2090
2100 VR=V*100+.5:VY=VR: VR=(INT(VR))/100:V$=STR$(VR)
2110 VX=VAL(V$)*100:V1$=STR$(VX)
2120 L=LEN(V1$):IF L<L1 THEN V1$=" "+V1$:GOTO2120
2130 Q=LEN(V$)
2140 FOR L=Q TO 1 STEP -1
2150 IF MID$(V$,L,1)<>". " THEN NEXT L:V$=V$+".00":GOTO2170
2160 IF L=Q-1 THEN V$=V$+"0"
2170 V2$=V$:V3$="$"+V$
2180 L=LEN(V2$):IF L<L2 THEN V2$=" "+V2$:GOTO2180
2190 L=LEN(V3$):IF L<L3 THEN V3$=" "+V3$:GOTO2190
2200 NG=0:IF V<0 THEN NG=1
2210 L=LEN(V$):L=L-1:V4$=RIGHT$(V$,L)
2220 V5$=V4$:IF L<6 THEN GOTO2260
2230 VA$=LEFT$(V4$,L-6):VB$=RIGHT$(V4$,6):V4$=VA$+", "+VB$:V5$=V4$
2240 V5$=V4$:IF L<10 THEN GOTO2260
2250 L=L+1:VA$=LEFT$(V4$,L-10):VB$=RIGHT$(V4$,10):V4$=VA$+", "+VB$
2260 IF NG THEN V4$="("+V4$+)"":GOTO2280
2270 V4$=" "+V4$+" "
2280 L=LEN(V4$):IF L<L4 THEN V4$=" "+V4$:GOTO2280
2290 IF NG THEN V5$=V5$+" CR":GOTO2310
2300 V5$=V5$+" "
2310 V6$="$"+V5$
2320 L=LEN(V5$):IF L<L5 THEN V5$=" "+V5$:GOTO2320
2330 L=LEN(V6$):IF L<L6 THEN V6$=" "+V6$:GOTO2330
2340 RETURN

```

## Listing 2. Demo Screen Dump

Note: Printer need not be on line to run.  
See Instuction 160.

```

100 REM ''DEMO SCREEN DUMP''
105 REM DUMP FOR OKIDATA 82A
110 REM F H SHEDD
120 REM FAIR OAKS, CA 95628
130 REM 916-961-1192

```



# programmer's tips

```
140 CL$=CHR$(147):PRINT CL$
150 PRINT"1 = PRINTER ON LINE FOR SCREEN DUMP"
160 PRINT"0 = NO PRINTER"
170 INPUT P1
180 OP=0
190 SU=0:SR=0:OP=OP+1:IF OP=7 THEN STOP
200 PRINT CL$;
210 IFOP <5 THEN PRINT "V = ENTRY * VR ROUNDED* ";
212 IF OP>4 THEN PRINT " V ENTERED * ";
220 IF OP=1 THEN PRINT" V1$ FORMAT"
230 IF OP=1 THEN PRINT" * * VALUE=CENTS"
240 IF OP=2 THEN PRINT " V2$ FORMAT"
250 IF OP=2 THEN PRINT " * * $ VALUE"
260 IF OP=3 THEN PRINT " V3$ FORMAT"
270 IF OP=4 THEN PRINT " V4$ FORMAT"
280 IF OP=4 THEN PRINT " *
282 IF OP=5 THEN PRINT " V5$ FORMAT"
284 IF OP=5 THEN PRINT " $ VALUE"
286 IF OP=6 THEN PRINT " V6$ FORMAT"
290 PRINT "=====
300 READ V
310 VT$=STR$(V)
320 L=LEN(VT$):IF L<10 THEN VT$=VT$+" ":GOTO 320
330 IF V>1E+10 THEN GOTO 420
340 GOSUB 2000
350 IF OP<5 THEN PRINT VT$;" *";V0$;" *";
355 IF OP>4 THEN PRINT VT$;" * ";
360 IF OP=1 THEN PRINT V1$
370 IF OP=2 THEN PRINT V2$
380 IF OP=3 THEN PRINT V3$
390 IF OP=4 THEN PRINT V4$
392 IF OP=5 THEN PRINT V5$
394 IF OP=6 THEN PRINT V6$
400 SU = SU + V : SR =SR+VR
410 GOTO 300
420 RESTORE
430 V=SR:GOSUB 2000
440 PRINT "SUM V = ";SU:PRINT " SUM V ROUNDED = ";V6$
450 PRINT "["
460 GOSUB 510
465 STOP
470 IF P1 THEN GOSUB 7000
480 GOTO 190
```



```

490 DATA .089,-1.1,0,123.456,-1234.552,123456.78,-9,23.499,.1,10
0,-.999
500 DATA 1E+11
510 PRINT"      PRESS SPACE BAR TO CONTINUE"
520 GET W$:IF W$=""THEN GOTO 520
530 RETURN
2000 REM** SUB PROGRAM 'V0123456$'
2010 L0=10:REM V0$  JUSTIFIED V
2020 L1=10:REM V1$ -> 12345678<- ROUNDED
2030 L2=11:REM V2$ -> 123456.78<- ROUNDED
2040 L3=12:REM V3$ ->$ 123456.78<- ROUNDED
2050 L4=13:REM V4$ ->(123,456.78)<- ROUNDED      OR
2060 L5=14:REM V5$ -> 123,456,78 CR<-
2070 L6=15:REM V6$ ->$123,456.78 CR<-
2080 L=LEN(V0$):IF L<L0THEN V0$=" "+V0$:GOTO2080
2090 VR=V*100+.5:VY=VR:  VR=(INT(VR))/100:V$=STR$(VR)
2100 VX=VAL(V$)*100:V1$=STR$(VX)
2110 L=LEN(V1$):IF L<L1 THEN V1$=" "+V1$:GOTO2110
2120 Q=LEN(V$)
2130 FOR L=Q TO 1 STEP -1
2140 IF MID$(V$,L,1)<>". "THEN NEXT L:V$=V$+".00":GOTO2160
2150 IF L=Q-1 THEN V$=V$+"0"
2160 V2$=V$:V3$="$"+V$
2170 L=LEN(V2$):IF L<L2 THEN V2$=" "+V2$:GOTO2170
2180 V0$=V2$
2190 L=LEN(V3$):IF L<L3 THEN V3$=" "+V3$:GOTO2190
2200 NG=0:IF V<0THEN NG=1
2210 L=LEN(V$):L=L-1:V4$=RIGHT$(V$,L)
2220 V5$=V4$:IF L<6 THEN GOTO2260
2230 VA$=LEFT$(V4$,L-6):VB$=RIGHT$(V4$,6):V4$=VA$+", "+VB$:V5$=V4
$
2240 V5$=V4$:IF L<10 THEN GOTO2260
2250 L=L+1:VA$=LEFT$(V4$,L-10):VB$=RIGHT$(V4$,10):V4$=VA$+", "+V
B$
2260 IF NG THEN V4$="("+V4$+)":GOTO2280
2270 V4$=" "+V4$+" "
2280 L=LEN(V4$):IF L<L4 THEN V4$=" "+V4$:GOTO2280
2290 IF NG THEN V5$=V5$+" CR":GOTO2310
2300 V5$=V5$+" "
2310 V6$="$"+V5$
2320 L=LEN(V5$):IF L<L5 THEN V5$=" "+V5$:GOTO2320
2330 L=LEN(V6$):IF L<L6 THEN V6$=" "+V6$:GOTO2330
2340 RETURN
7000 REM  SCREEN DUMP - F H SHEDD 9/83

```



# programmer's tips

```
7005 REM DUMP FOR OKIDATA 82A
7010 REM LEFT BRACKET [ ENDS DUMP
7020 SI$=CHR$(15):BS$=CHR$(8):PO$=CHR$(16):RV$=CHR$(18):RO$=CHR$(146)
7030 QT$=CHR$(34):MF$=CHR$(145):VR=PEEK(648)*256
7040 OPEN 4,4,10
7050 PRINT#4,"....."
7060 PRINT#4,":          S-C-R-E-E-N  D-U-M-P          :":
7070 PRINT#4,"*****"
7080 FOR CL = 0 TO 24
7090   QF=0:AS$=MF$
7100   FOR RO = 0 TO 39
7110     SC= PEEK(VR+40*CL+RO)
7120     IF SC = 34 THEN QF = 1-QF
7130     IF SC<>162 THEN 7160
7140     QF= 1-QF: IF QF = 1 THEN AS$=RV$+QT$:GOTO 7220
7150     AS$= AS$+QT$+RO$:GOTO 7180
7160     IF QF = 1 AND (SC>128) THEN SC = SC -128:GOTO 7180
7170     IF SC>= 128 THEN SC = SC - 128:RF=1:AS$=AS$+RV$
7180     IF SC< 32 OR SC > 95 THEN AS = SC+ 64:GOTO 7210
7190     IF SC >31 AND SC < 64 THEN AS = SC:GOTO 7210
7200     IF SC>63 AND SC<96 THEN AS = SC+32:GOTO 7210
7210     AS$=AS$+CHR$(AS)
7220     IF RF = 1 THEN A$=AS$+RV$:RF=0
7230     IF AS =91 THEN GOTO 7290
7240     NEXT RO
7250     IF QF = 0 THEN PRINT#4,SI$PO$"* "AS$"*":GOTO 7270
7260     PRINT#4,SI$+PO$+"20"+AS$+QT$
7270     NEXT CL
7280     PRINT#4,SI$
7290     PRINT#4,"*****"
7300     CLOSE 4
7310     RETURN
```



IF YOU CAN'T DECIDE  
WHICH COMPUTER TO GET,  
GET ALL OF THEM.

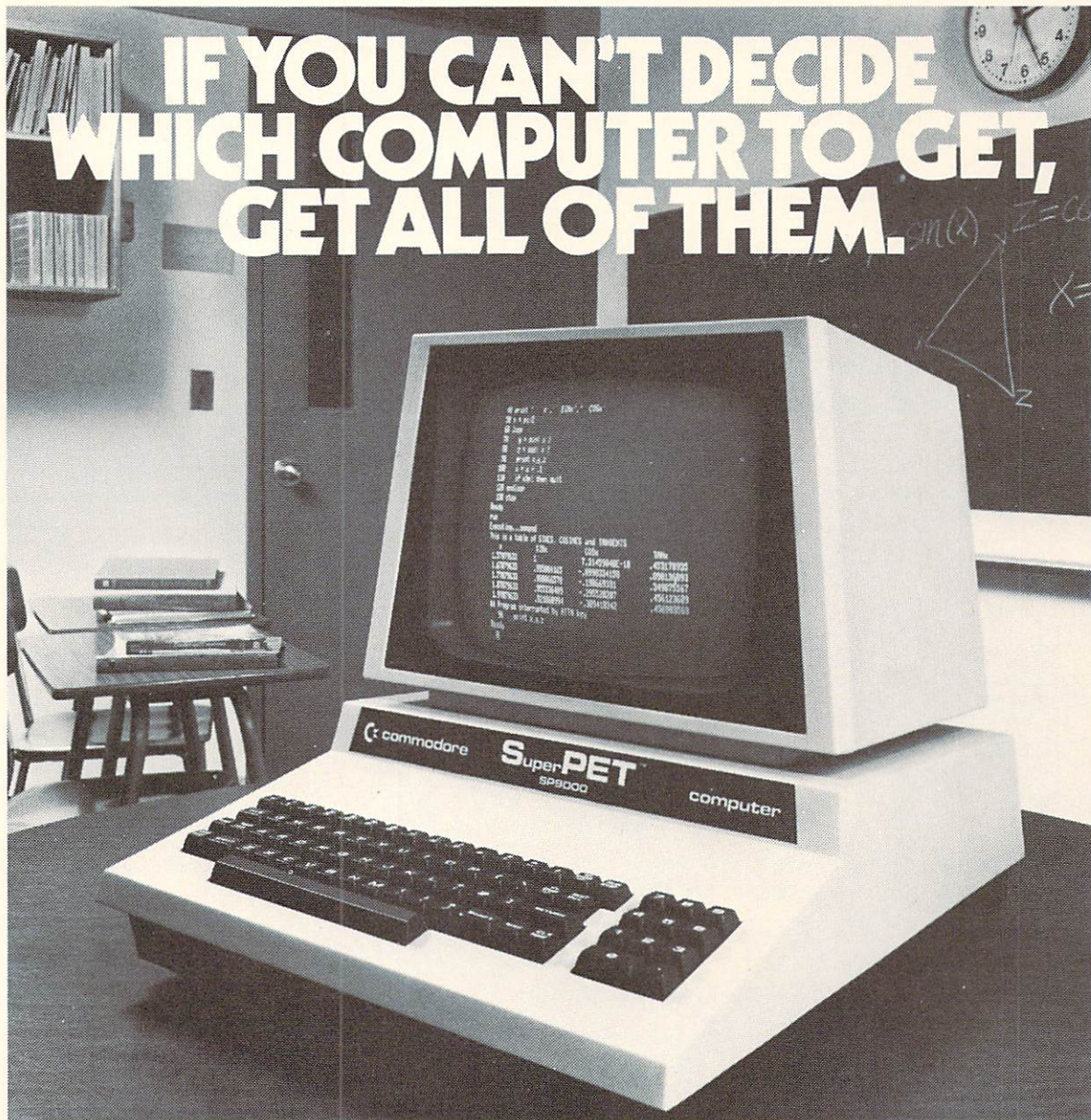

## THE SUPERPET.™ 5 LANGUAGES

It's not easy finding a microcomputer that can fulfill all of your requirements. Unless you've discovered the Commodore SuperPET.™

The SuperPET is the *only* microcomputer that comes with five of the most powerful structured languages: MicroBASIC, MicroAPL, MicroFORTRAN, MicroPASCAL, and MicroCOBOL.

We think you'll agree it's far and away the most complete computer you can buy for your school.

 **commodore**  
COMPUTER



## Screen Dumps of Demonstration Data: Program "Demo Screen Dump"

```

:          S-C-R-E-E-N  D-U-M-P          :
*****
* V = ENTRY   * VR   ROUNDED*  V1$ FORMAT *
*              *      * VALUE=CENTS *
* =====
*  .089       *    .09 *      9
* -1.1        *   -1.10 *     -110
* 0           *    0.00 *      0
* 123.456     *   123.46 *   12346
* -1234.552   * -1234.55 * -123455
* 123456.78   * 123456.78 * 12345678
* -9          *   -9.00 *   -900
* 23.499      *   23.50 *   2350
* .1          *    .10 *    10
* 100         *  100.00 *  10000
* -.999       *   -1.00 *   -100
* SUM V = 122458.273
* SUM V ROUNDED = $122,458.28
*****

```

```

:          S-C-R-E-E-N  D-U-M-P          :
*****
* V = ENTRY   * VR   ROUNDED*  V3$ FORMAT *
*              *      * ===== *
*  .089       *    .09 *      $ .09
* -1.1        *   -1.10 *     $-1.10
* 0           *    0.00 *      $ 0.00
* 123.456     *   123.46 *     $ 123.46
* -1234.552   * -1234.55 *    $-1234.55
* 123456.78   * 123456.78 *    $ 123456.78
* -9          *   -9.00 *     $-9.00
* 23.499      *   23.50 *     $ 23.50
* .1          *    .10 *      $ .10
* 100         *  100.00 *    $ 100.00
* -.999       *   -1.00 *     $-1.00
* SUM V = 122458.273
* SUM V ROUNDED = $122,458.28
*****

```

```

:          S-C-R-E-E-N  D-U-M-P          :
*****
* V = ENTRY   * VR   ROUNDED*  V2$ FORMAT *
*              *      * $ VALUE *
* =====
*  .089       *    .09 *      .09
* -1.1        *   -1.10 *     -1.10
* 0           *    0.00 *      0.00
* 123.456     *   123.46 *   123.46
* -1234.552   * -1234.55 * -1234.55
* 123456.78   * 123456.78 * 123456.78
* -9          *   -9.00 *   -9.00
* 23.499      *   23.50 *   23.50
* .1          *    .10 *    .10
* 100         *  100.00 *  100.00
* -.999       *   -1.00 *   -1.00
* SUM V = 122458.273
* SUM V ROUNDED = $122,458.28
*****

```

```

:          S-C-R-E-E-N  D-U-M-P          :
*****
* V = ENTRY   * VR   ROUNDED*  V4$ FORMAT *
*              *      * ===== *
*  .089       *    .09 *      .09
* -1.1        *   -1.10 *     (1.10)
* 0           *    0.00 *      0.00
* 123.456     *   123.46 *   123.46
* -1234.552   * -1234.55 *   (1,234.55)
* 123456.78   * 123456.78 * 123,456.78
* -9          *   -9.00 *     (9.00)
* 23.499      *   23.50 *   23.50
* .1          *    .10 *    .10
* 100         *  100.00 *  100.00
* -.999       *   -1.00 *     (1.00)
* SUM V = 122458.273
* SUM V ROUNDED = $122,458.28
*****

```



# TEACHERS

useful programs for COMMODORE 64™ and PET®

**MASTER GRADES** — The complete grading system for teachers. Even prints progress notes to parents. Easy to use!  
Disk only - \$39.50

**FOOTBALL SCOUT** — Feed your scouting reports into the computer and beat your opposition.  
Disk only - \$79.50

**BASKETBALL STATS** — Keeps the stats for your team for the whole season. Reports are great motivators.  
Disk only - \$39.50

**KINDER KONCEPTS** — 30 programs, cover the whole Kindergarten curriculum. PET is the only version available from us. Commodore Business Machines, Inc. is distributing the Commodore 64 version. Send for the PET (16K or 32K) demo disk.  
only \$10.00

OTHER USEFUL  
PROGRAMS  
AVAILABLE

ADD \$2.00  
PER DISK  
FOR POSTAGE  
AND HANDLING

SCHOOL PURCHASE  
ORDERS AND  
PERSONAL CHECKS  
WELCOME



**MIDWEST SOFTWARE**  
BOX 214 • FARMINGTON, MI 48024

Phone: (313) 477-0897 (Between 4:00 pm and 11:00 pm)

TM AND ® ARE REGISTERED TRADEMARKS OF COMMODORE BUSINESS MACHINES, INC.

```
.....
:          S-C-R-E-E-N  D-U-M-P          :
*****
*  V ENTERED  *      V5$ FORMAT          *
*              *      $ VALUE            *
*  =====  *  =====                *
*  .089      *      .09                  *
* -1.1       *      1.10 CR              *
* 0          *      0.00                 *
* 123.456    *      123.46               *
* -1234.552  *      1,234.55 CR          *
* 123456.78  *      123,456.78          *
* -9         *      9.00 CR              *
* 23.499     *      23.50                *
* .1         *      .10                  *
* 100        *      100.00               *
* -.999      *      1.00 CR              *
* SUM V = 122458.273                    *
* SUM V ROUNDED = $122,458.28          *
*****
```

```
.....
:          S-C-R-E-E-N  D-U-M-P          :
*****
*  V ENTERED  *      V6$ FORMAT          *
*              *      $ VALUE            *
*  =====  *  =====                *
*  .089      *      $.09                  *
* -1.1       *      $1.10 CR              *
* 0          *      $0.00                 *
* 123.456    *      $123.46               *
* -1234.552  *      $1,234.55 CR          *
* 123456.78  *      $123,456.78          *
* -9         *      $9.00 CR              *
* 23.499     *      $23.50                *
* .1         *      $.10                  *
* 100        *      $100.00               *
* -.999      *      $1.00 CR              *
* SUM V = 122458.273                    *
* SUM V ROUNDED = $122,458.28          *
*****
```

## SimplexSoft Ltd.

### FINANCIAL RECORD SYSTEM For VIC 20™—Commodore 64™

- Record, total, and/or print all income sources
- Record, total, and/or print all expenses
- Record, total, and/or print all the items on the most complex US tax forms (car, travel, entertainment, supplies, contributions, medical, local & state taxes, etc.)
- Review & Edit all entries by day, week, month, year, and/or by category (car, medical, taxes, etc.)
- Store & Retrieve all Data on tape or disk

**TAX TIME WILL TAKE AN HOUR OR SO  
NOT DAYS OR WEEKS**

#### IDEAL FOR:

- Individual & Multi-Income family financial & tax records
- Self employed & company Reps. on expense accounts
- Apartment owners and managers
- Small Contractors (Bldg., Plumbing, Heating, Elect., Etc.)
- Truck owners/operators
- Farmers
- Any other small businesses

**NO KNOWLEDGE OF COMPUTER LANGUAGE  
NEEDED—ALL IN PLAIN ENGLISH**

VIC 20 version requires 16K memory expander  
(Printer not required)  
SimplexSoft 2 tape system only.....\$29.95  
Disk..... 34.95  
Specify cassette or disk and computer model  
Add \$2.00 for mailing.

Send check or money order to:

**SimplexSoft, Ltd.**  
617 N. Property Lane  
Marion, Iowa 52302

VIC 20 and Commodore 64 are trademarks of Commodore Electronics Ltd.

DEALERS  
DON'T MISS OUT—ANYONE CAN DEMO THIS SYSTEM  
AND LOOK PROFESSIONAL



## Listing 3. Demo Printer

```
100 REM ' ' DEMO PRINTER ' ' OKIDATA 82A
110 OPEN 1,4,15
120 PRINT#1,CHR$(27)+CHR$(66):REM OKI SHORT LINE
130 PRINT CHR$(147):PRINT#1,CHR$(29):REM OKI CONDENSED
140 L1$="=====
150 H1$="V0$ LEN 10 :V1$ LEN 10 : "
160 H5$=" INPUT V : ROUNDED : "
170 A1$=" ACTUAL : CENTS : "
180 L2$="=====
190 H2$="V2$ LEN 11 :V3$ LEN12 : "
200 H6$=" VALUE : : "
210 A2$=" $ : VALUE : "
220 L3$="=====
230 H3$="V4$ LEN 13 :V5$ LEN 14 : "
240 H8$=" VALUE : VALUE : "
250 A3$=" $ : $ : "
260 L4$="=====
270 H4$="V6$ LEN 15 "
280 H9$=" VALUE"
290 A4$=""
300 PRINT#1,L1$+L2$+L3$+L4$
310 PRINT#1,H1$+H2$+H3$+H4$
320 PRINT#1,H5$+H6$+H7$+H8$+H9$
330 PRINT#1,A1$+A2$+A3$+A4$
340 PRINT#1,L1$+L2$+L3$+L4$
345 SU=0:SR=0
350 READ V
355 IF V > 999999999 THEN GOTO 500
360 GOSUB 2000
400 PRINT#1, V0$;" *";V1$;" * ";V2$;" *";V3$;" *";V4$;" *";V
5$;" *";V6$
410 SU =SU+V:SR=SR+VR
450 GOTO 350
500 RESTORE
510 PRINT#1,L1$+L2$+L3$+L4$
520 PRINT#1," UNROUNDED TOTAL = ";SU
530 V=SR:GOSUB2000
540 PRINT#1," ROUNDED TOTAL = ";V6$
900 CLOSE 1:STOP
1000 DATA 12345,123456.78,-1.236
1010 DATA -12341.763,45.469,0,-10.111,122.987,-555.5211,.11678,9
09.995
1100 DATA 1E+10
```



```

2000 REM** SUB PROGRAM 'V0123456$'
2010 L0=10:REM V0$ JUSTIFIED V
2020 L1=10:REM V1$ -> 12345678<- ROUNDED
2030 L2=11:REM V2$ -> 123456.78<- ROUNDED
2040 L3=12:REM V3$ ->$ 123456.78<- ROUNDED
2050 L4=13:REM V4$ ->(123,456.78)<- ROUNDED OR
2060 L5=14:REM V5$ -> 123,456.78 CR<-
2070 L6=15:REM V6$ ->$123,456.78 CR<-
2075 V0$=STR$(V)
2080 L=LEN(V0$):IF L<L0THEN V0$=V0$+" ":GOTO2080
2090 VR=V*100+.5:VY=VR: VR=(INT(VR))/100:V$=STR$(VR)
2100 VX=VAL(V$)*100:V1$=STR$(VX)
2110 L=LEN(V1$):IF L<L1 THEN V1$=" "+V1$:GOTO2110
2120 Q=LEN(V$)
2130 FOR L=Q TO 1 STEP -1
2140 IF MID$(V$,L,1)<>"." THEN NEXT L:V$=V$+"."00":GOTO2160
2150 IF L=Q-1 THEN V$=V$+"0"
2160 V2$=V$:V3$="$"+V$
2170 L=LEN(V2$):IF L<L2 THEN V2$=" "+V2$:GOTO2170
2180 REM V0$=V2$
2190 L=LEN(V3$):IF L<L3 THEN V3$=" "+V3$:GOTO2190
2200 NG=0:IF V<0THEN NG=1
2210 L=LEN(V$):L=L-1:V4$=RIGHT$(V$,L)
2220 V5$=V4$:IF L<6 THEN GOTO2260
2230 VA$=LEFT$(V4$,L-6):VB$=RIGHT$(V4$,6):V4$=VA$+", "+VB$:V5$=V4$
2240 V5$=V4$:IF L<10 THEN GOTO2260
2250 L=L+1:VA$=LEFT$(V4$,L-10):VB$=RIGHT$(V4$,10):V4$=VA$+", "+VB$
2260 IF NG THEN V4$="("+V4$+)":GOTO2280
2270 V4$=" "+V4$+" "
2280 L=LEN(V4$):IF L<L4 THEN V4$=" "+V4$:GOTO2280
2290 IF NG THEN V5$=V5$+" CR":GOTO2310
2300 V5$=V5$+" "
2310 V6$="$"+V5$
2320 L=LEN(V5$):IF L<L5 THEN V5$=" "+V5$:GOTO2320
2330 L=LEN(V6$):IF L<L6 THEN V6$=" "+V6$:GOTO2330
2340 RETURN
2350 END

```



# SUPERTAX™ Get Supertax now and relax on April 15th . . .

## SECOND SUCCESSFUL YEAR! • THOUSANDS ALREADY IN USE!

Use SUPERTAX personal income tax programs to calculate your tax liability now and have plenty of time to make year-end investment decisions to improve your position. SUPERTAX was specifically created for Commodore 64 users by a practicing CPA with a Master's degree in tax accounting. Highly acclaimed by tax pros, SUPERTAX is easy to understand and a pleasure to work with.

- SUPERTAX PROGRAMS are fully screen-prompted and included manual loaded with valuable tax information and guidance.
- SUPERTAX instantly recalculates your entire return when you change any item.
- SUPERTAX is available on cassette and diskette.
- SUPERTAX DATA can be stored on cassette and diskette.
- SUPERTAX is available at 50% off to prior purchasers for all subsequent year's programs.
- SUPERTAX is an essential addition to your personal software library—best of all it's tax deductible.

### SUPERTAX I

Using either screen or printer output, SUPERTAX I generates clear and concise summaries of Page 1 and 3 and Schedule A of FORM 1040 allowing you to see at a glance and to quickly comprehend your tax situation. This program also prints an OVERALL SUMMARY of the return showing Adjusted Gross Income, Itemized Deductions, Taxable Income, Regular Tax, Income Averaging Tax, Minimum Tax and Payment Due or Refund—all of which are calculated by the program. SUPERTAX I also calculates the moving expense deduction, investment credit, taxable capital gains, political and child care credits, medical limitations, and much more. Input is fast and easy and changes can be made in seconds. This program actually makes tax planning a breeze.

**Cassette or Diskette \$79**

### SUPERTAX II

Includes the efficient SUPERTAX I program as well as the more detailed SUPERTAX II program which makes all of the SUPERTAX I calculations, but which also PRINTS THE INCOME TAX RETURN. This program prints page 1, page 2, Schedules A, B, and G (income averaging) of the FORM 1040 as well as FORM 3468 (investment tax credit) on standard government forms or on blank computer paper for use with transparencies. Any input item can be changed in seconds and the entire return is recalculated almost instantly.

**Diskette only \$89**

**NOTE:** Printing on government forms requires friction feed printer.

### SUPERTAX III

This package includes both the SUPERTAX I and SUPERTAX II programs PLUS a program to calculate and print Schedule C of the FORM 1040. Also included is a stand alone depreciation program which calculates and prints your depreciation schedule using both the old rules and the new ACRS rules. Output from the depreciation program is designed to serve as a supplement to IRS FORM 4562.

**Diskette only \$99**

Products shipped FOB Dallas, TX  
Commodore 64 is a trademark of Commodore Business Machines

For Free Brochure WRITE  
**Rockware Data Corporation**  
10525 Barrywood Drive  
Dallas, Texas 75230

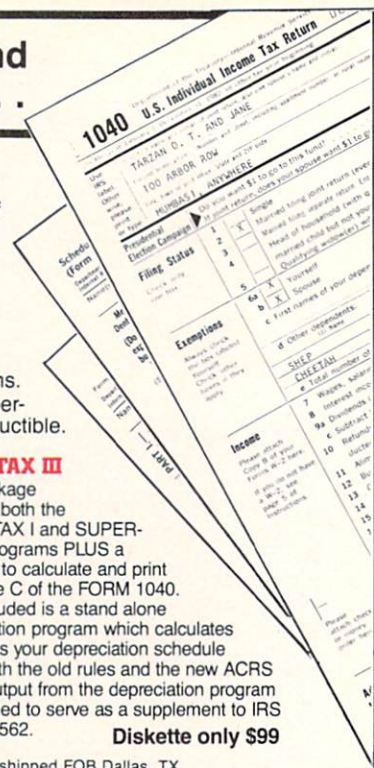

## programmer's tips

### Demonstration of Printed Output Using Subroutine V0123456\$

V0\$ LEN 10	:V1\$ LEN 10	:V2\$ LEN 11	:V3\$ LEN12	:V4\$ LEN 13	:V5\$ LEN 14	:V6\$ LEN 15
INPUT V	: ROUNDED	: VALUE	: VALUE	: VALUE	: VALUE	: VALUE
ACTUAL	: CENTS	: \$	: VALUE	: \$	: \$	: \$
12345	* 1234500 *	12345.00	* \$ 12345.00 *	12,345.00	* 12,345.00 *	* \$12,345.00
123456.78	* 12345678 *	123456.78	* \$ 123456.78 *	123,456.78	* 123,456.78 *	* \$123,456.78
-1.236	* -124 *	-1.24	* \$-1.24 *	(1.24)	* 1.24 CR *	* \$1.24 CR
-12341.763	* -1234176 *	-12341.76	* \$-12341.76 *	(12,341.76)	* 12,341.76 CR *	* \$12,341.76 CR
45.469	* 4547 *	45.47	* \$ 45.47 *	45.47	* 45.47 *	* \$45.47
0	* 0 *	0.00	* \$ 0.00 *	0.00	* 0.00 *	* \$0.00
-10.111	* -1011 *	-10.11	* \$-10.11 *	(10.11)	* 10.11 CR *	* \$10.11 CR
122.987	* 12299 *	122.99	* \$ 122.99 *	122.99	* 122.99 *	* \$122.99
-555.5211	* -55552 *	-555.52	* \$-555.52 *	(555.52)	* 555.52 CR *	* \$555.52 CR
.11678	* 12 *	.12	* \$ .12 *	.12	* .12 *	* \$.12
909.995	* 91000 *	910.00	* \$ 910.00 *	910.00	* 910.00 *	* \$910.00
<b>UNROUNDED TOTAL = 123971.717</b>						
<b>ROUNDED TOTAL = \$123,971.73</b>						



# Prints Charming

by Andy Gamble

*Add some pizzazz to your programs. For all Commodore computers.*

I'm bored. I'm so very bored with dull programs. You know which ones they are: their presentation is unexciting, remarkably static or just plain dull. Of course you would be annoyed if you paid good money for programs like these, but why settle for less in the programs you write yourself? Fortunately help is at hand, and from an unlikely source.

Watching TV the other evening, a rare thought struck me. It was during one of those movies that make commercials seem interesting and something to look forward to. Suddenly I realized that the commercials were indeed better than the film, and were probably better than MOST films in one sense: their graphic messages. I started flipping through the channels, looking for commercials and making notes and drawings of the graphic techniques they used.

Of course this should come as no big surprise. Advertising is a huge industry and nothing less than perfect sells a product. Computer graphics have had a large effect on the way we expect messages to be presented and the advertising industry has been quick to pick this up and develop the technique. You can now see very impressive graphics everywhere, from commercials for dog food to the intro to the news.

Now I'm not suggesting that your own home computer can necessarily mimic the combined talents of a Michaelangelo and a "Tron" programmer, but amazingly effective graphics can be produced with a minimum of bother. Bear in mind that these are impossible to demonstrate on the printed page, so you are urged to enter the following sample routines into your machine and RUN them. Somewhat apologetically I call them "Prints Charming".

First of all, note that the string to be charmingly printed is A\$ in all that follows. The examples also make use of the string functions MID\$, LEFT\$ and RIGHT\$. Perhaps this is a good place to review these functions.

MID\$, LEFT\$ and RIGHT\$ are most often used to isolate single characters or groups of characters from a string, and this is the case for these programs.

In greater detail:

LEFT\$(A\$,X) isolates the X "left-most" characters of the string A\$, so that if A\$ = SINISTER, LEFT\$(A\$,3) would return "SIN".

RIGHT\$(A\$,X) does the same for the "right-most" characters: if A\$ = DEXTROUS, RIGHT\$(A\$,2) returns "US".

MID\$(A\$,X,Y) is slightly more complicated: It chooses Y characters beginning at character number X. Assigning A\$ = KERNEL, MID\$(A\$,2,3) would return "ERN". In these examples the Y value is mostly one, meaning that we are choosing one character from the middle of the string.

Incorporating any of these little gems into your own programs is child's play. Rather than print out the CBM cursor control characters, I've used the following conventions:

[CU] is Cursor Up  
[CD] is Cursor Down  
[CL] is Cursor Left  
[CR] is Cursor Right  
[RVS] is Reverse Video On

You should of course press the appropriate cursor control key instead of the above codes.

The first one I call "Slow Motion Print" (which is actually more exciting than it sounds). Try this small routine:

```
100 A$="SLO-MO PRINT"  
110 FOR I=1 TO LEN(A$)  
120 FOR ZZ=1 TO 200: NEXT ZZ  
130 PRINT MID$(A$,I,1);: NEXT I  
140 PRINT
```



# programmer's tips

Line 120 controls the speed of printing, commonly called a "delay loop". Numbers lower than 200 will speed up the printing and vice versa. The value 200 is about right for normal reading speed.

Here's "Sliding Print", which lives up to its name:

```
100 A$="SLIDING PRINT"
110 A$="          "+A$
120 FOR I=1 TO LEN(A$)
130 PRINT MID$(A$,LEN(A$)-I+1,
  I);"[CU]"
140 FOR ZZ=1 TO 25: NEXT ZZ:
  NEXT I
```

The blanks in line 110 pad out the rather short string so that it ends up in the middle of a 40-column screen. (You might not need these for a longer message or for a VIC screen.)

"Word Crash" is similar: Letters crash into each other, traveling left to right.

```
100 A$="WORD-CRASH"
110 FOR I=LEN(A$) TO 1 STEP-1
120 FOR ZZ=1 TO 25-LEN(A$)+I
130 PRINT TAB(ZZ)" "MID$(A$,I,
  1);"[CU]"
140 NEXT ZZ
150 NEXT I
```

Change the 25 in line 120 to a smaller number (say 10) if you are using a VIC.

I have to admit that I was stuck for a name for this next one: Since it seems as though the string

is zooming out of the middle of the screen from hyperspace, in deference to all space cadets I called it "Hyper-Print":

```
100 A$="THIS IS A DEMO OF
  HYPER-PRINT"
110 A=LEN(A$): IF A/2 <> INT
  (A/2) THEN A$=" "+A$:
  GOTO 110
120 FOR I=1 TO A/2
130 PRINT TAB(21-I); LEFT$(A$,
  I); RIGHT$(A$,I)
140 PRINT"[CU]";
150 FOR ZZ=1 TO 50: NEXT ZZ
160 NEXT I
```

Line 110 expands the string to an even number of characters, if need be (the string is divided into two parts for the zooming). We do not use the MID\$ function this time but rather the LEFT\$ and RIGHT\$ functions. Again, line 150 merely slows down the effect a little. "Hyper-Print" works best on longer strings of 20 characters or more. Again, change the 21 in line 130 to about 10 for a VIC, and use short strings for A\$.

"Slo-Under" is my name for this next effect, which is very useful for emphasizing parts of a text at reading speed. As you'll see, it underlines words slowly.

```
100 A$="THIS IS A DEMO OF 'SLO-
  UNDER'. LET'S HOPE IT
  WORKS!"
110 L=40: IF LEN(A$)<40 THEN
  L=LEN(A$)
120 PRINT LEFT$(A$,L)
130 IF L=40 THEN PRINT"[CU]";
```



```

140 FOR I=1 TO L
150 PRINT CHR$(163);
160 FOR ZZ=1 TO 30: NEXT ZZ
170 NEXT I
180 A$=RIGHT$(A$,LEN(A$)-L)
190 IF A$<>"" THEN 110

```

In this program A\$ is split into lengths of 40 characters (the width of the PET screen) by lines 110,120 and 180. These sub-strings are then printed with a blank line between each, which is where the underline character goes (163 in line 150). The process continues as long as there is a string A\$ left (line 190). Change the 40 in lines 110 and 130 for the VIC screen to 22.

"Alpha-Print" is likewise harder to explain than to type. For each letter of the message the alphabet whizzes by, stopping at the correct character:

```

100 A$="ALPHA-PRINT"
110 FOR I=1 TO LEN(A$)
120 M=ASC(MID$(A$,I,1))
130 IF M<65 OR M>90 THEN PRINT
    CHR$(M);: NEXT I
140 FOR J=65 TO M
150 PRINT CHR$(J);" [CL]";
160 NEXT J
170 PRINT "[CR]";
180 NEXT I

```

In CBM ASCII the letter A is 65 and Z is 90: Line 130 traps all non-letters and prints them directly.

"Twinkle-Print" alternates characters in the string between normal and reverse video at random:

```

100 A$="TWINKLE-PRINT"
110 PRINT A$
120 ZL=LEN(A$): DIM ZS(ZL)
130 ZR=INT(ZL*RND(1)+1)
140 PRINT "[CU]"; TAB(ZR-1);
150 IF ZS(ZR)=0 THEN ZS(ZR)=1
    :PRINT "[RVS]"; MID$(A$,
    ZR,1):
    GOTO 130
160 IF ZS(ZR)=1 THEN ZS(ZR)=0
    :PRINT MID$(A$,ZR,1):
    GOTO 130

```

An array ZS( ) is set up to show the normal/reverse state of each character (0 or 1). Characters chosen at random by ZR in line 130 are then "flipped".

The last example makes the individual letters move up and down one line (they look as if they're bouncing). The technique is almost the same as the previous one, but definitely much sillier.

```

100 A$="BOUNCE-PRINT"
110 PRINT A$
120 ZL=LEN(A$): DIM ZS(ZL)
130 ZR=INT(ZL*RND(1)+1)

```



# ESP-Calc

by new leaf inc.™

the first truly  
easy-to-use spreadsheet

for your VIC-20™ or Commodore 64™:

Do you feel lost in a sea of un-ending paperwork? But, have you been waiting to purchase a spreadsheet program until one was made that is easy-to-use? Wait no more . . . **ESP-Calc** was designed for you!

**ESP-Calc** runs on both the Commodore 64™ and the VIC 20™, with 24K added. This means you can "step-up" from a VIC-20™ to a Commodore 64™, without needing to purchase a new spreadsheet. Plus, as with our other programs, you even have the option of printed spreadsheets on your Commodore™ compatible printer.

**ESP-Calc's** maximum spreadsheet size is limited only by your computer's memory. This means that on a VIC-20™, you can get approximately 1000 cells, and on a Commodore 64™, approximately 2000 cells. Plus help screens are available to you as you use the program.

The two-color manual comes in a three ring binder with dividers, a quick reference card, liberal use of examples and an index. It's a step-by-step guide that will allow even novice users to operate the spreadsheet program. The screen commands are printed in a contrasting color to make it easier to use. We have also included complete examples of a utility cost spreadsheet, a stock portfolio analysis and a rental income analysis.

But . . . here's the very best news of all. The price!

Disk Version . . . . . 47.50

Cassette Version . . . . . 43.50

also available . . .

**DIORHYTHM+** Cassette Only . . . 14.50

please state VIC-20™ or Commodore 64™

**C\*A\*R\*S** (runs on both VIC-20™ & Commodore 64™)

Disk Version . . 27.50 Cassette Version . . 24.50



Product ordered \_\_\_\_\_

VIC-20™       Commodore 64™

Disk             Cassette

Amount enclosed \_\_\_\_\_

Name \_\_\_\_\_

Address \_\_\_\_\_

City \_\_\_\_\_ State \_\_\_\_\_ Zip \_\_\_\_\_



Phone Number (      ) \_\_\_\_\_

MC or VISA # \_\_\_\_\_

Expiration date \_\_\_\_\_

Interbank # (MC) \_\_\_\_\_

Missouri residents add 5.125% sales tax  
120 Lynnhaven • Belleville, IL 62223

Mastercard and VISA customers, please add 3%  

## programmer's tips

```

140 PRINT"[CU]"; TAB(ZR-1);

150 IF ZS(ZR)=0 THEN ZS(ZR)=1:
    PRINT"[CU]";
    MID$(A$,ZR,1);"[CD][CL]";" " :
    GOTO 120
160 IF ZS(ZR)=1 THEN ZS(ZR)=0:
    PRINT
    MID$(A$,ZR,1);"[CU][CL]";" " ;"
    [CD]": GOTO 120

```

Note that there are single spaces between quotes in lines 150 and 160.

And finally a word of caution: Printing charmingly does not necessarily make a good program. As in all good things, a little goes a long way. But using one or two of these effects in your programs could brighten them up no end. And don't forget that very useful source of ideas, the TV commercial. Soon you'll be getting up to make some coffee during the movie, and not during the breaks. . .

C



## COMAL Graphics

by Len Lindsay

*The COMAL programming language is available in the public domain for Commodore's PET/CBM and Commodore 64 computers. Here the author of the COMAL Handbook explains COMAL's LOGO-like graphics capabilities.*

The Commodore 64 is a very fine computer. However, controlling its many advanced graphics features can be cumbersome if you use only the BASIC that comes with the computer. COMAL is one advanced programming language that takes up where BASIC left off. It adds, among other things, a turtle graphics system as well as sprite controls. In my last article, I explained COMAL as a programming language. This article will briefly explain COMAL as a graphics language.

Turtle graphics were popularized by the LOGO programming language. In fact, turtle graphics are often incorrectly called LOGO graphics. With the introduction of COMAL for the Commodore 64, users now have two fine languages, both of which include a similar turtle graphics system. Both LOGO and COMAL are disk loaded. However, LOGO is on a protected, copyrighted disk, while COMAL is public domain.

I have compiled several charts to help illustrate and explain COMAL graphics. First, I would like you to look at the chart comparing the turtle graphics systems of LOGO and COMAL. Notice that they are very similar; both are based on the turtle graphics in M.I.T. LOGO. The chart also illustrates the few differences between the two systems. Next, you can refer to the chart of COMAL graphics keywords. This is a fairly complete list of all the keywords relating to the graphics system, including syntax and examples.

### Turtle Graphics

Most of us are familiar with graphics using the X,Y coordinate plotting system. COMAL graphics includes this familiar system. This system, however, is

a very rigid, absolute system. After a lot of research, M.I.T. (Massachusetts Institute of Technology) came up with the more flexible, relative graphics system now called turtle graphics.

The idea of using a "turtle" in a graphics system may seem a bit strange at first, but once you have tried it, you will understand its significance. It is not restricted only to children's pictures. It can be used for serious charting as well.

Imagine a turtle sitting in the middle of your screen. It has 16 different colored pens. It is "holding" one of the pens. If this pen is "down", whenever the turtle moves it will leave a line behind of that pen's color. However, if the pen is "up", no line will be drawn, since the pen is not down on the screen. You have full control over the turtle's movements. In COMAL, you can even vary the size of your turtle from small to big, with ten different sizes. And if you don't want to see the turtle, you can "hide" it, making it an invisible turtle. It still will move around and draw lines, but you will not be able to see it.

### Moving the Turtle

Moving the turtle is a relatively simple matter. Movement is in "units". If you want the turtle to move forward 50 units, simply enter:

```
FORWARD 50
```

If you want the turtle to move back 15 units, you would enter:

```
BACK 15
```

You can also "put" the turtle at any specific X,Y location you want. To put it at X,Y coordinates 160,100 you would enter:

```
SETXY 160,100
```



## Turning the Turtle

Your turtle can move forward and back, but not sideways (except using the SETXY command). To move the turtle sideways, you first "turn" the turtle either left or right. The turning is specified in "degrees", with 90 being a right angle and 360 being a complete turn, back to the same heading as the turtle started with. To turn the turtle left 90 degrees simply enter:

```
LEFT 90
```

To turn the turtle right 1 degree, you would enter:

```
RIGHT 1
```

While most of the time you will turn your turtle with either a LEFT or RIGHT command, you also can tell it to face any specific absolute direction. To set its heading to 180 degrees, you would enter:

```
SETHEADING 180
```

## The Turtle's Pen

The turtle is always holding one pen. It can be one of 16 colors. These colors are numbered in the same manner as listed in the Commodore 64 users manual (see the chart on page 93). If you would like the turtle to be holding a white pen (white is color 1), simply enter:

```
PENCOLOR 1
```

In order for the turtle to leave lines behind while it moves, you must tell it to put its pen down:

```
PENDOWN
```

If you don't want your turtle to draw lines, simply enter:

```
PENUP
```

## Background

You can set the background and border colors easily with COMAL graphics. To set the color of the background to black (color 0) simply enter:

```
BACKGROUND 0
```

To set the border to red (color 2) you would enter:

```
BORDER 2
```

## Try It

You now know enough about your turtle to draw a picture on the screen. The turtle's pen and the background and border all have default settings. We will use these settings in our first examples simply because they are good settings and the examples will be easier.

To go into "graphics mode" you simply enter the command DRAW. Your turtle starts in the center of the screen with its pen down. It is pointing straight up. The background is black, the border is black, and the pen is white.

Now, let's have the turtle draw a simple box that is 40 units square. Issue the following commands:

```
FORWARD 40
```

```
LEFT 90
```

```
FORWARD 40
```

```
LEFT 90
```

```
FORWARD 40
```

```
LEFT 90
```

```
FORWARD 40
```

```
LEFT 90
```



I hope you noticed that you issued a FORWARD and LEFT command sequence four times. You did this in direct mode while in the graphics mode (i.e., the DRAW command issued previously). We could write a short COMAL program to do the same thing, but we would write the program in the text mode. To go into text mode simply issue the command TEXT.

```
1Ø PROC SQUARE
2Ø   FOR SIDE=1 TO 4 DO
3Ø     FORWARD 4Ø
4Ø     LEFT 9Ø
5Ø   ENDFOR SIDE
6Ø ENDPROC SQUARE
```

Notice that COMAL lets you define your own procedures. In user-defined procedures, the parameters are enclosed in parentheses. Thus you enter SQUARE(90) instead of SQUARE 90. The COMAL system will remember any procedures and functions in your program after it is run as well as while it is running. Thus once you have entered your program (such as the procedure SQUARE above) you must issue the command RUN to "initialize" your user-defined procedure. Then you can use the SQUARE command from direct mode as often as you want, as long as you don't change the program.

Remember that while in text mode, the turtle will still follow your commands, but you will not be able to see it, or anything it does. To go back to the graphics screen you issue the command DRAW. Now, once your program is run you can draw a square anytime by giving the command SQUARE.

Drawing a square that is the same size all the time can be quite boring. We can use a variable with any of the turtle commands. COMAL also allows us to pass values into a procedure (called PROC). Thus we

could write a flexible SQUARE procedure like this:

```
1Ø PROC SQUARE(LENGTH)
2Ø   FOR SIDES=1 TO 4 DO
3Ø     FORWARD LENGTH
4Ø     LEFT 9Ø
5Ø   ENDFOR SIDES
6Ø ENDPROC SQUARE
```

Now, to have the turtle draw a square, simply issue the command (remember to RUN the program first and to be in graphics mode):

```
SQUARE(8Ø)
```

## A Familiar Design

Now let's set up a flexible yet simple design procedure. The SQUARE procedure had the length of a side as its variable and always used 90 as the degrees to turn. Now let's have the number of degrees to turn to be the variable and have the length of the side increase by one after each side is drawn:

```
PROC DESIGN(ANGLE)
  CLEARSCREEN
  FOR SIDE=1 TO 99 DO
    FORWARD SIDE
    RIGHT ANGLE
  ENDFOR SIDE
ENDPROC DESIGN
```



# computer languages

To see some designs give these commands:

```
DESIGN (89)  
DESIGN (91)  
DESIGN (59)
```

## A Complete Squares Program

Now we can write a complete program to draw some squares on the screen. To use this program we only need to issue the command RUN. Everything is done automatically after that. First make sure you are in text mode:

```
NODRAW
```

Next make sure to clear out any previous program:

```
NEW
```

Now, to make program writing easier, use automatic numbering:

```
AUTO  
0010 BACKGROUND 0  
0020 BORDER 0  
0030 DRAW  
0040 REPEAT  
0050     PENUP  
0060     SETXY RND(0,320),  
        RND(0,200)  
0070     PENDOWN  
0080     SETHEADING RND(0,359)  
0090     PENCOLOR RND(1,15)
```

```
0100     SQUARE(RND(5,50))  
0110 UNTIL KEY$<>CHR$(0)  
0120 //  
0130 PROC SQUARE(LENGTH)  
0140     FOR SIDES=1 TO 4 DO  
0150         FORWARD LENGTH  
0160         LEFT 90  
0170     ENDFOR SIDES  
0180 ENDPROC SQUARE  
0190 just hit return here
```

To look at your program simply tell the computer to list it for you:

```
LIST
```

Now, save your program in your disk:

```
SAVE "SQUARES"
```

Finally, run the program:

```
RUN
```

The program will now draw squares that are a random color, random size, at random angles in random locations on the screen. It will continue until you press any key.

## Start Playing

You are now ready to start playing with your new turtle friend. You will be surprised how many things you can draw. As you define design commands, put



them into a procedure. Then you can draw that design at any time simply by calling it by name.

## Next Time

Next time I will cover manipulating sprites using

COMAL. The procedure is very easy since COMAL has built-in sprite commands—no more PEEKs and POKEs to have some spritely fun. **C**

## COMAL

### Graphics Keywords

#### **BACK** <length>

BACK 40 moves turtle backwards 40 units  
moves turtle back the number of units specified

#### **BACKGROUND** <color number>

BACKGROUND 2 sets the background to red (2)  
sets background color to the one specified

#### **BORDER** <color number>

BORDER 2 sets the border to red (2)  
sets the border color to the one specified

#### **CLEARSCREEN**

CLEARSCREEN clears graphic screen—turtle is not affected

#### **CLEARTEXT**

CLEARTEXT clears text screen

#### **CORRECTION** <percentage>

CORRECTION .87  
corrects for your screen so a circle is a circle not an oval

#### **DRAW**

DRAW go into graphics screen

#### **DRAWTO** <x coordinate>, <y coordinate>

DRAWTO 45,80 draws a line from current point to 45,80  
draws a line to point specified (x/y graphics—not turtle)

#### **FILL** <x coordinate>, <y coordinate>

FILL 25,80 fills in the area that includes point 25,80  
fills the area containing the specified point with current color

#### **FORWARD** <length>

FORWARD 40 moves turtle forward 40 units  
moves turtle forward the number of units specified

#### **FRAME** (<x0>, <x1>, <y0>, <y1>)

FRAME(0,320,0,200) sets the sides of the screen:  
horizontally from 0 to 320  
and vertically from 0 to 200  
sets the four sides of the screen

#### **FULLSCREEN**

FULLSCREEN goes to a fullscreen graphics screen

#### **GETCOLOR** (<x coordinate>, <y coordinate>)

GETCOLOR(25,80) returns the color number of the point 25,80  
returns the color number of the specified coordinate point

#### **HEADING**

HEADING returns the current turtle heading number in degrees

#### **HIDESCREEN**

HIDESCREEN turns screen off without disturbing its contents

#### **HIDETURTLE**

HIDETURTLE make the turtle invisible



# computer languages

## HOME

HOME put the turtle in its home position

## LEFT <degrees>

LEFT 90 turn left 90 degrees  
changes turtles heading by specified degrees to the left

## MOVETO <x coordinate>,<y coordinate>

MOVETO 50,80 moves to point 50,80 without drawing a line  
moves to specified point without leaving a line (x/y graphics)

## NODRAW

NODRAW goes to the text screen

## PENCOLOR <color number>

PENCOLOR 2 sets the current pen color to red (2)  
changes the color of the turtle and its pen

## PENDOWN

PENDOWN puts the pen down so a line is drawn when turtle moves

## PENUP

PENUP picks up pen so no line is drawn when turtle moves

## PLOT <x coordinate>,<y coordinate>

PLOT 35,70 plots a point at location 35,70 in current color  
plots a point in the current pencolor at specified coordinates

## PLOTTEXT <x coordinate>,<y coordinate>,<text\$>

PLOTTEXT 16,24,"TESTING" prints TESTING on graphics screen  
prints text onto the graphics screen starting at x,y specified

## RIGHT <degrees>

RIGHT 90 turns turtle 90 degrees to right (a right angle)  
changes turtle's heading by specified degrees to the right

## SCALE <x0>,<x1>,<y0>,<y1>

SCALE -500,500,-200,200 sets the screen to 'cover' points horizontally from -500 thru 500 and vertically from -200 through 200  
sets the coordinates of the four sides of the screen

## SETHEADING <degree>

SETHEADING 0 sets the turtle's heading to 0 degrees  
changes turtle's heading to that heading specified

## SETX <x coordinate>

SETX 20 positions turtle with same y coordinate and 20 x coordinate  
sets the turtle's x coordinate to the one specified

## SETXY <x coordinate>,<y coordinate>

SETXY 20,50 positions the turtle to location 20,50  
sets the turtle's x and y coordinates as specified

## SETY <y coordinate>

SETY 30 positions turtle with same x coordinate and 30 y coordinate  
sets the turtle's y coordinate to the one specified

## SHOWSCREEN

SHOWSCREEN turns the screen on

## SHOWTURTLE

SHOWTURTLE the turtle is now visible

## SPLITSCREEN

SPLITSCREEN goes to graphic screen with 2 line text area



**TURTLESIZE** < size >

TURTLESIZE 6 sets the size of the turtle to 6  
vary the size of turtle from small (0) to large (10)

**XCOR**

XCOR returns the x coordinate of the turtle

**YCOR**

YCOR returns the y coordinate of the turtle C

**Commodore 64 COMAL Colors List**

Color Value	Color Name	Color Value	Color Name
0	Black	8	Orange
1	White	9	Brown
2	Red	10	Light Red
3	Cyan	11	Dark Grey
4	Purple	12	Medium Grey
5	Green	13	Light Green
6	Blue	14	Light Blue
7	Yellow	15	Light Grey C

**Commodore 64 COMAL Resource List**

Available from COMAL Users Group, 5501 Groveland Terrace, Madison, WI 53716 (608) 222-4432:

- COMAL on disk with programs, \$15
- COMAL Handbook, by Len Lindsay, \$19
- Turtle Sourcebook, by Jim Muller, \$22
- Newsletter, Info, List of local user groups, \$2

Available from Educational Company of Ireland Ltd., Ballymount Road, Dublin, 12 Ireland:

Foundations in Computer Studies With  
COMAL, by John Kelly

Available from Ellis Horwood Limited, Market Cross House, Cooper Street, Chichester, West Sussex PO19 1EB England:

Beginning COMAL, by Borge Christensen  
Structured Programming With COMAL,  
by Roy Atherton C

NEW Home Workstation!

**Improve Your Commodore Home Computer System...**

...with the **C•A•T!**

The C•A•T will organize your total computer system and provide a large work area with plenty of storage space for software and manuals.

- **COMPACT** Requires minimum floor space.
- **FUNCTIONAL** Centralizes hardware and software. Large work area. Right or left hand oriented. Printer paper feeds through shelf.
- **COMFORTABLE** Standard typing height, keyboard shelf. Adjustable leg levelers.
- **ATTRACTIVE** Designed to fit any decor. Vinyl, walnut finished shelves for maintenance free beauty.
- **STURDY** Engineered for years of service. 16 gauge steel. 5/8" laminated, flakeboard shelves. 56 lbs.
- **EASY TO ASSEMBLE** Assembles in minutes.

NOW AVAILABLE AT A  
SPECIAL INTRODUCTORY PRICE **\$149.95**  
Visa or Master Charge Shipping charges collect.



Natl. 800-872-3333 Call Toll Free PA 800-292-9660

Name \_\_\_\_\_  
Address \_\_\_\_\_  
City \_\_\_\_\_ State \_\_\_\_\_ Zip \_\_\_\_\_  
Phone \_\_\_\_\_ MC  VISA   
Card No. \_\_\_\_\_ Expiration Date \_\_\_\_\_  
Check enclosed, \$ \_\_\_\_\_ for \_\_\_\_\_ Computer Access Tables, Model C  
PA residents add 6% sales tax.

Order today from: Suckle Manufacturing Corp.  
733 Davis Street Scranton, PA 18505





# computer languages

## Turtle Graphics: LOGO and COMAL

Items	CBM LOGO	CBM COMAL
<b>Turtle Control:</b>		
Move forward length	FORWARD	FORWARD
Move to a point	SETXY	SETXY
Move only x coordinate	SETX	SETX
Move only y coordinate	SETY	SETY
Move backward length	BACK	BACK
Home turtle	HOME	HOME
Turn turtle left	LEFT	LEFT
Turn turtle right	RIGHT	RIGHT
Turn to specific heading	SETHEADING	SETHEADING
Make turtle visible	SHOWTURTLE	SHOWTURTLE
Make turtle invisible	HIDETURTLE	HIDETURTLE
Pen up off paper	PENUP	PENUP
Pen down on paper	PENDOWN	PENDOWN
Set pen color	PENCOLOR	PENCOLOR
Pen to erase	PENERASE	PENERASE
Number of colors	16	16
Colors set by NAME/NUM	by number	by number
Set size of turtle	—	TURTLESIZE
Plot a point	—	PLOT
<b>Values Returned:</b>		
Get color of point	—	GETCOLOR
Get X position of turtle	XCOR	XCOR
Get Y position of turtle	YCOR	YCOR
Get current heading	HEADING	HEADING
<b>Screen and Color Control:</b>		
Clearscreen	CLEARSCREEN	CLEARSCREEN
Clear text screen	CLEARTEXT	CLEARTEXT
Set to graphics mode	DRAW	DRAW
Set to text screen	NODRAW	NODRAW
Set a screen boundary	—	FRAME
Set background color	BACKGROUND	BACKGROUND
Set border color	—	BORDER
Fill in an area	—	FILL
Full screen mode	FULLSCREEN	FULLSCREEN
Split screen mode	SPLITSCREEN	SPLITSCREEN

C



## Promqueen/64

Reviewed by Jeff Bruette

The Promqueen/64 is both a device that allows you to read and write EPROMs and a software development tool. It is for use on the Commodore 64 and the SX-64 computers. The PQ/64 is manufactured by the Gloucester Computer Company, the same company that developed the original Promqueen for the VIC 20.

With the Promqueen/64 you can write programs then put them on EPROMs. An EPROM, or Erasable/Programmable Read Only Memory, is a chip that retains a program in memory even after the power has been turned off. The only way to erase the program is by directing ultraviolet light onto the EPROM. With the PQ/64 you can create programs for the Commodore 64, VIC 20 or any other device that uses EPROMs. In addition to the hardware, the PQ/64 comes with a utility called HEXKIT.

The PQ/64 plugs directly into the cartridge port. On top, it has a ZIF (zero insertion force), 28-pin socket. There is a mode switch that allows the PQ/64 to be in any of three states. The modes are "off", "copy" and "burn". The most intriguing switch is what is called a "matrix switch". This switch is used to select the type of EPROM that the PQ/64 will be dealing with. Because of this switch there is no need for the "personality modules" used in most other EPROM burners.

The PQ/64 can read and write to many different types of EPROMs. This list includes 2516, 2532, 2564, 2716, 27C16, 2732, 27C32, 2764, 2758 and 27128. In addition, the PQ/64 was designed with future developments in mind. This means that when 32K byte EPROMs become available the PQ/64 will be able to handle them. There is a potentiometer which can be adjusted to select the necessary voltage for the EPROM that is being used. One other feature is a reset button that can be used to "cold start" the computer without erasing the RAM.

The HEXKIT utility software that is supplied with the PQ/64 is a useful development tool. It comes on an EPROM which, using HEXKIT itself, can be saved on disk or tape. In HEXKIT there is an edit mode, which lets you look at and modify any mem-

ory location in RAM. In addition, when programming, you can specify labels that can be used in jump vectors. When debugging a program, you can set breakpoints so your program will stop at these points. Once your code has been written you have the option to save it. You can save to disk or tape as well as sending your program to the RS232 port. If you would like a printed copy, your code can be saved to the printer.

Your next step would be to make an EPROM of your program. After setting the matrix switch and voltage to match the EPROM that is being used, put the EPROM in the ZIF socket. When the option to burn is selected, you are asked where the code that is to be burned is located. This is useful because different programs may be in different memory locations. After you enter the address range a check is made to verify that a blank EPROM is being used. If the EPROM is not blank or is bad, the software brings this to your attention. This is quite handy since a blank EPROM looks just like an EPROM that has a program on it.

If everything is OK, the programming of the EPROM begins and the screen displays what address is being burned. After the PQ/64 has burned the program into the EPROM it verifies that the code that is in RAM matches the code on the EPROM. If, for some reason, there is an error, the screen displays the address at which the error occurred.

In conclusion, it is my opinion that the Promqueen/64 is a necessary tool for developers as well as hobbyists who wish to learn more about programming and hardware. On a scale of one to ten, I'd rate Promqueen/64 like this:

Quality:	9
Ease of use:	9
Documentation:	8
Usefulness:	10
Price/Performance:	9
Support:	10

Average: 9.1

C



## A Theory of Operation for the VIC/64 Boards

by Jim Gracely

*The "board" inside your computer is laid out in "functional blocks". Here is a simple explanation of what each block does.*

How does the VIC or 64 work? This is an interesting question, and it actually has a number of completely different answers. Ask a BASIC programmer and he'll explain to you how the page zero pointers are used and how the BASIC ROM uses the kernal routines. Ask a machine language programmer and he'll explain how interrupts are used and how the microprocessor uses the stack. In this article however, we're going to look at the two computers from a hardware point of view. What exactly is on the computer board inside that plastic case and how does it work?

To explain how the VIC and 64 computer board operates, I am going to use a functional block description. This is accompanied by a functional block diagram and explains how the board can be divided into functions (i.e., memory, I/O etc.). These descriptions are only to increase your understanding of the computer, and are not intended to be a technical training course.

I want to note at this time that these descriptions are going to be for both the VIC and the 64. On the functional level, the two computers are just about identical and in areas where there are differences I will discuss both machines.

### Functional Blocks

The computer board on both the VIC and the 64 can be divided into four functional blocks.

- 1) Control and Timing
- 2) Data Input/Output
- 3) Audio/Video Output
- 4) Memory

Figures 1 and 2 are block drawings of the boards and can be referred to while reading the following descriptions.

### Control and Timing

This block controls every other block in the system. It contains the central processing unit, the clock crystal and timing chips.

Central Processing Unit: Here is the heart of both computers. It is this single component which controls all internal functions of the computers. Any program, whether written in BASIC, machine language or Pascal is translated and run by the CPU. The CPU also controls all input and output of data both within the system and to all peripherals.

On the VIC board, the CPU is a 6502 chip. This is the "host chip" for this issue and there are a number of other articles in this issue on it.

On the 64 board, the CPU is a 6510 chip. This is the same as the 6502 chip with one small difference. There are two special input/output registers in the chip. One register is an input/output port. The other register is a data direction register (DDR) and determines whether the bits of the first register are to be used as input

or output. One of the special uses of these registers is to communicate with the datassette.

### Data Input/Output

This block is the interface between the Control and Timing block and all data-oriented devices. These devices include the keyboard, joysticks, disk drive, cassette and printer.

On the VIC board, this block contains two VIA (Versatile Interface Adapter) chips. VIA #1 communicates with the keyboard and the cassette. It also provides output data to the serial port (disk drive or printer). VIA #2 communicates with the user port and joystick and accepts the input data from the serial port.

On the 64 board, this block contains two CIA (Complex Interface Adapter) chips. CIA #1 communicates with the keyboard and both joystick ports. CIA #2 communicates with the user port and the serial port (disk drive or printer).

### Audio/Video Output

This block is the interface between the Control and Timing block and a TV or monitor. This block also communicates with the Memory block and the Input/Output block.

In the VIC this block contains the VIC (Video Interface Controller) chip. This chip accepts paddle input data and provides the audio and video signals for the video/audio port.

In the 64 this block contains the



VIC II chip, the SID (Sound Interface Device) chip and an RF (Radio Frequency) modulator. The VIC II chip provides video output to both the RF modulator and the audio/video port. The SID chip accepts input from paddles and provides audio output for the RF modulator and the audio/video port. The SID chip also accepts an audio input from the audio/video port. The RF modulator "modulates" the audio and

video signals so that they can be used by a television.

### Memory

This block contains all of the RAM (Random Access Memory) and ROM (Read Only Memory) that is available in the computer.

Both the VIC and the 64 contain two 8K X 8 ROM chips (one for BASIC and one for the kernel). Both also contain a 4K X 8 character ROM chip and have a

1K X 4 color RAM chip. The VIC contains ten 1K X 4 RAM chips for a total of 5K bytes of RAM, part of which is for the screen and BASIC working storage (0-1023). The 64 contains eight 64K X 1 RAM chips for a total of 64K bytes of RAM. C

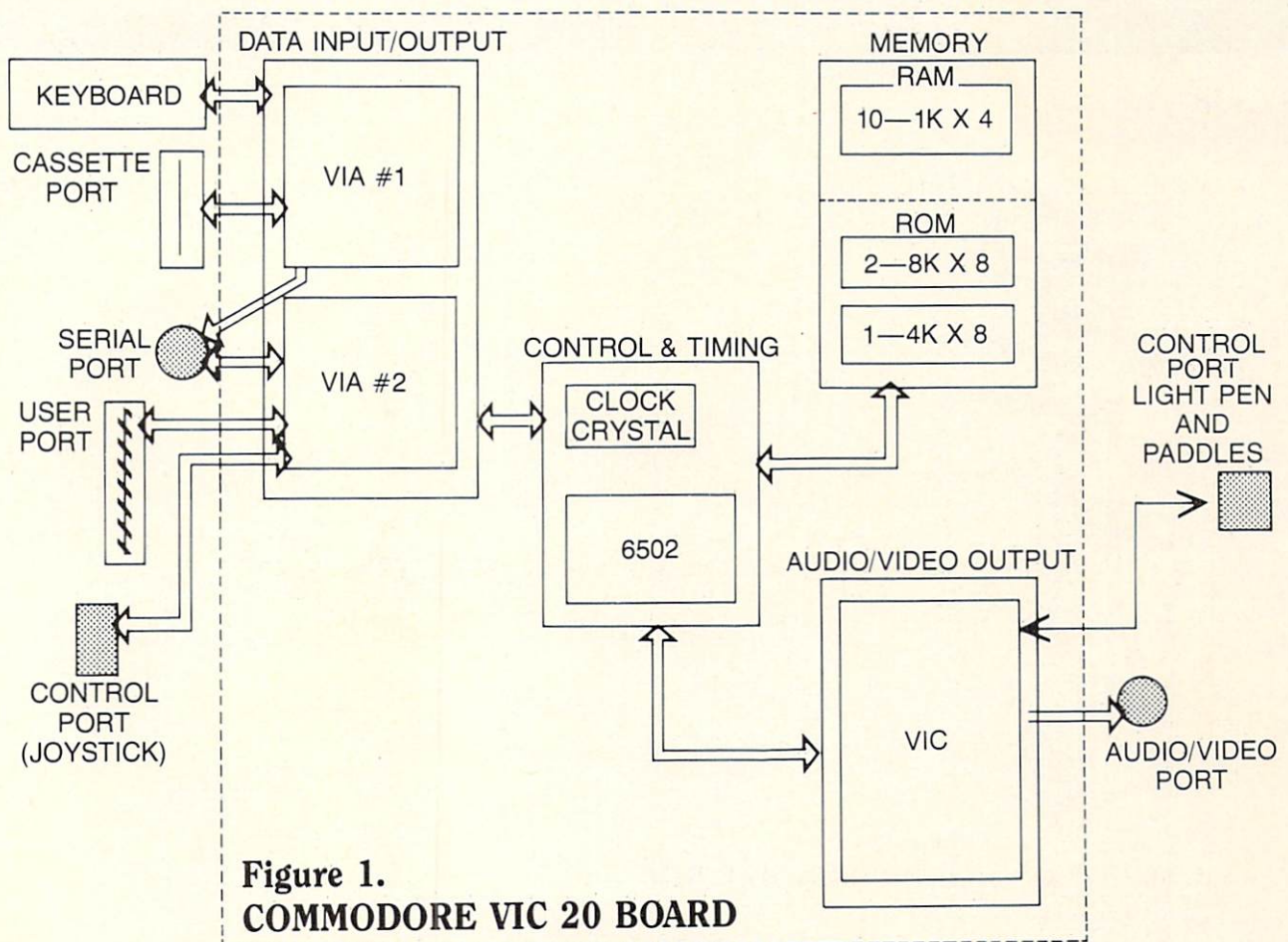

**Figure 1.**  
**COMMODORE VIC 20 BOARD**



# VIC & 64



AT LAST! The information you need, without always going back to the manual. These durable plastic coated overlays contain program starting locations, function key labeling, commands and additional aids in center cutout.

Please send me the following Leroy's Cheatsheet™ keyboard overlays

- |                                |  |                                |   |
|--------------------------------|--|--------------------------------|---|
| <input type="checkbox"/> 20 64 | <input type="checkbox"/> Programmer's Aid <sup>1</sup> | <input type="checkbox"/> 20 64 | <input type="checkbox"/> Graphic printer (1515 & 1525) <sup>1</sup> |
| <input type="checkbox"/>       | <input type="checkbox"/> Vicmon <sup>1</sup>           | <input type="checkbox"/>       | <input type="checkbox"/> UMI Wordcraft 20 <sup>2</sup>              |
| <input type="checkbox"/>       | <input type="checkbox"/> Super Expander <sup>1</sup>   | <input type="checkbox"/>       | <input type="checkbox"/> HES Vic Forth <sup>3</sup>                 |
| <input type="checkbox"/>       | <input type="checkbox"/> Vic Typewriter <sup>1</sup>   | <input type="checkbox"/>       | <input type="checkbox"/> HES Writer <sup>3</sup>                    |
| <input type="checkbox"/>       | <input type="checkbox"/> Victerm 1 <sup>1</sup>        | <input type="checkbox"/>       | <input type="checkbox"/> Wordpro 3 plus                             |
| <input type="checkbox"/>       | <input type="checkbox"/> Term 64 <sup>1</sup>          | <input type="checkbox"/>       | <input type="checkbox"/> Easy Script <sup>1</sup>                   |
| <input type="checkbox"/>       | <input type="checkbox"/> Quick Brown Fox               | <input type="checkbox"/>       | <input type="checkbox"/> Basic                                      |

CM1283

Send check or money order plus \$ 1.00 (postage and handling)  
PA residents add 6% sales tax.

Name \_\_\_\_\_

Address \_\_\_\_\_

City \_\_\_\_\_ State \_\_\_\_\_ Zip \_\_\_\_\_

(1) Products of Commodore Business Machines, Inc. (2) Product of United Microware Industries, Inc.  
(3) Products of Human Engineered Software. VIC-20 is a Trademark of Commodore Business Machines, Inc.

**CHEATSHEET PRODUCTS™**

P.O. Box 8299 Pittsburgh PA. 15218 (412) 456-7420

TAX AID TAX AID TAX AID



FOR **COMMODORE 64™**  
AND **VIC 20™**

USE **TAX AID™**  
TO PREPARE YOUR INCOME TAX

DEVELOPED BY AN EXPERIENCED ACCOUNTING FIRM

EASY TO USE DETAILED MANUAL

UPDATES AVAILABLE YEARLY

	TAPE	DISK
<b>TAX AID I™</b> FOR UNEXPANDED VIC 20	\$19.95	\$24.95
<b>TAX AID II™</b> FOR VIC 20 WITH 16K	\$24.95	\$29.95
<b>TAX AID III™</b> FOR COMMODORE 64	\$24.95	\$29.95

**NORTHLAND ACCOUNTING**

606-B SECOND AVENUE  
TWO HARBORS, MN 55616  
(218) 834-5012

COMMODORE 64 IS A TRADEMARK OF COMMODORE ELECTRONICS, LTD.  
VIC 20 IS A TRADEMARK OF COMMODORE ELECTRONICS, LTD.  
TAXAID IS A TRADEMARK OF NORTHLAND ACCOUNTING, INC.

TAX AID TAX AID TAX AID

## technical

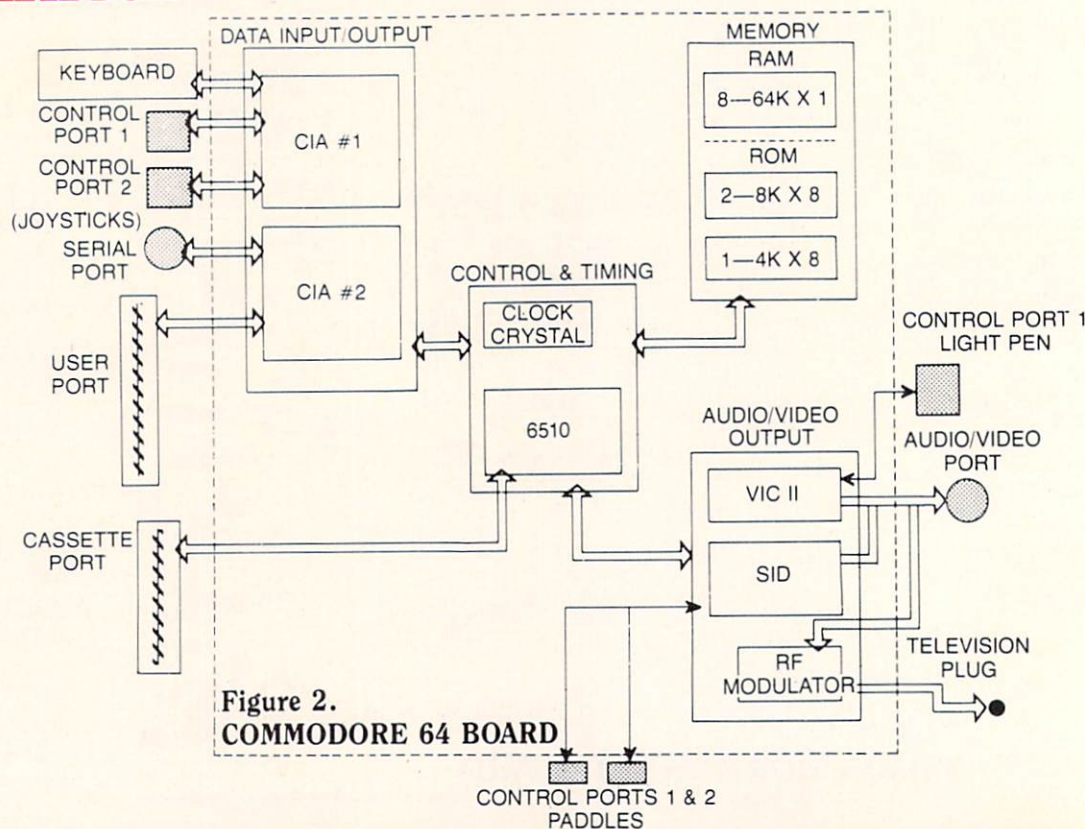

Figure 2.  
COMMODORE 64 BOARD



## The New Commodore Information Network

by Barbara Karpinski

### *Commodore's telecommunications network has expanded.*

Many of you may have heard of the Commodore Information Network (CIN) on CompuServe. You may have read about CIN either as part of a snap-pak offer with the VICMODEM or AUTOMODEM or in the March, 1983, *Commodore* magazine article by Jeff Hand. BUT... if you haven't accessed CIN lately, you haven't seen anything yet. Since that last March update, CIN has grown and expanded rapidly. On page 100 is an outline of the new CIN.

### **Bulletin Boards**

One of the most noticeable areas of rapid growth is in our National Bulletin Board (BBS). We have split our Commodore BBS Interest Group into three separate BBS's—one for the VIC 20 computer, one for the Commodore 64, and one dedicated to our CBM business machines (CBM/PET, SuperPET and "B" Machine).

One good analogy for a BBS is to think of it as a club. If you want, you can become a member and participate in all the club has to offer or you can just look around to see if you want to join. Like any special interest club, our three BBS's offer different topics of interest depending on what members want to see. These topics are contained in either the SIG (Special Interest Group) area, the conference area (CO) or in the databases of each BBS.

In the SIG, you can communicate with other members by posting either private or public messages. In our CO area you can set up online conferences or attend one of the many that CBM sponsors. The third feature of every BBS is the databases. In these areas are stored files, programs, errata, answers to technical questions and lots more.

### **VIC 20 Bulletin Board**

Some topics of interest in this SIG are:

1. HOTLINE answers to frequently asked questions about the VIC 20.
2. A large collection of application and

recreation programs.

3. A library of past *Commodore* and *Power/Play* magazine programs.
4. Weekly conferences on popular topics.

### **Commodore 64 Bulletin Board**

These are some of the new topics in this SIG:

1. The whole collection of educational public domain programs.
2. A "New Languages/FORTH" section where members who are interested in this topic can share ideas and program knowledge.
3. An entire section dedicated to CBM CP/M<sup>®</sup> programs. (CP/M is a registered trademark of Digital Research, Inc.)
4. A lot of music programs including the Entertainer.
5. Conferences are held in this SIG weekly.

### **CBM Business Machines Bulletin Board**

Business-oriented machines are featured here, notably the CBM/PET, SuperPET and the "B" machine.

1. One section is reserved for each of the three computer lines mentioned above.
2. An Educational area is set up for all to use.
3. Information and errata on the business machines can be found here.

Explanations of the commands to get around in each area of the Bulletin Boards can be found in the March, 1983, issue of *Commodore* magazine or online by either typing "H" at any [! or FUNCTION:] prompt or by going to our Survival Kit choice [go CBM4] at the [! or FUNCTION:] prompt.

### **Main Menu Update**

Our main menu or display area, which has been outlined above, has also been updated. Perhaps the most exciting addition to this menu is the NEW UPDATES TO CIN choice. When you choose this option you will see which area has been updated and the date. In this way you do not have to keep scanning each videotex page for recent changes. All you need do is to periodically check this area to see



## Commodore Information Network's Main Menu

Intro & Survival Kit -----	-Direct Access Page Numbers - Videotex Area Explanation - Bulletin Boards Expl. ----- -HOTLINE Instructions	-Introduction - SIG Explanation - Database Explanation  - Conferencing - Vendor Advertising -Uploading/Downloading
New Updates to CIN		-VIC 20 Material - C-64 Subject Matter - Disk Drive Info. - Printer Information - 8000/9000 Series - Software Material - Modem Material - Monitor -Miscellaneous
HOTLINE Menu -----	-Introduction -Self-Help Files ----- -HOTLINE (Ask Questions)	
Product Announcements		
Bulletin Boards Menu -----	-VIC 20 Users Group ----- -C-64 Users Group----- -CBM Bus Machines Users Group -----	Each BB Composed of: 1. SIG 2. Conference 3. Databases
Magazine Articles-----	-Commodore: MicroComputer Mag. ----- -Power/Play Mag. -----	Preview Abstracts of upcoming articles.
Directories -----	-Dealers across USA & Canada -User Groups across USA & Canada	
Commodore Tips -----	-Software Tips  -Hardware Tips  -Computers - Hardware -----	-VIC 20/C-64 -PET/CBM
CBM Product Line-	- Software ----- - Mag./Books/Manuals -Accessories	-For VIC 20 -For C-64 -For PET/CBM
User Questionnaire		



if we have made any changes to CIN since the last time you were on. This option will also save you from wasting precious time that can be spent for more important matters such as downloading new programs and responding to messages.

### Videotex or Display Area

Below are the ten main choices in the display (videotex) area and a short explanation of each.

CBM-1—This is the page number of our main menu. To get to any area in CompuServe you can search by going through the menu structure choices or by typing in the appropriate page number of the topic. Following is a direct access index guide for a few of the topics that can be found in CIN.

Topic	Page Number
Main Menu -----	cbm-001
Intro/Survival KIT -----	cbm-004
Direct Access Index -----	cbm-021
Videotex Explanation -----	cbm-024
Bulletin Boards Menu -----	cbm-029
HOTLINE Explanation -----	cbm-041
Database Explanation -----	cbm-047
HOTLINE Menu -----	cbm-964
HOTLINE (ask questions) -----	cbm-200
Product Announcements -----	cbm-007
Bulletin Boards Menu -----	cbm-006
VIC 20 BB -----	cbm-962
C-64 BB -----	cbm-963
CBM Bus. Machine BB -----	cbm-310
Commodore Magazines Menu -----	cbm-009
Commodore magazine -----	cbm-096
Power/Play magazine -----	cbm-181
Directories Menu -----	cbm-010
Dealer List -----	cbm-246
User Groups List -----	cbm-248
Commodore Tips Menu -----	cbm-011
Software Tips -----	cbm-466
Technical Tips -----	cbm-467
Product Line -----	cbm-012

1) *Intro/Survival Kit*: A comprehensive user guide for this Network. Includes an explanation of commands.

- 2) *New Updates To CIN*: Already explained above.
- 3) *HOTLINE*: A service provided by Commodore to its customers to answer technical and general questions. You can leave a message on the HOTLINE and expect an answer in your electronic mail within several days.
- 4) *Product Announcements*: (What's New) A listing of new CBM products and events.
- 5) *Bulletin Boards*: This area was also explained above.
- 6) *Commodore Articles*: Here you will find abstracts of upcoming articles from CBM magazines.
- 7) *Directories*: Here you can find an up-to-date list of user groups and dealers across the U.S. and Canada.
- 8) *Commodore Tips*: Have trouble with programming? Consult our CBM software tips section for new ideas. In addition, our technical tips section has information on how to do neat things with your computer.
- 9) *CBM Product Line*: A product line listing of all our software and hardware products.
- 10) *User Questionnaire*: A user questionnaire designed to give CBM a better idea of who uses CompuServe so we can serve you better.

Since nothing in this world stays static, least of the Commodore Information Network, we will periodically be informing you of new updates, additions and changes to CIN—A sort of “what’s new” in CIN. So watch for our updates and if you happen to think of a brilliant idea or contribution for our Network, let us know about it.

C



## The New Model 1650 AUTOMODEM

by James E. Darrough

*Commodore's new AUTOMODEM, for the VIC 20 and Commodore 64, provides automatic dialing, automatic answering and more.*

Recently Commodore sent me a new product for review, which I am sure will be of interest to those of us into telecommunications. This new product is the Model 1650 AUTOMODEM, now available at your dealer. The AUTOMODEM will operate nicely with the VIC 20 or Commodore 64, although you must presently write your own software to take advantage of autodialing and autoanswering on the VIC. However, I did manage to try out a prototype of VICTERM-40 at NCC, and it will work nicely with the AUTOMODEM. (The VICTERM-40 cartridge should be out within a month or so after this article is published.)

In contrast to the VICMODEM, the AUTOMODEM is a bit larger. It measures about five inches in width and four in depth, although the thickness of the cartridge is about the same. There are, however, vast improvements inside. The three main advantages over the VICMODEM are:

1. Autodial/Autoanswer capability.
2. Switch-select for telephone or modem.
3. Switch-selectable duplex.

Along with the drastic software price decreases by Commodore we have all seen lately, this new autodial/autoanswer modem should put the "icing on the cake." For the suggested retail price of \$149.95 I feel this modem falls into the "great deal" category. For one thing, it plugs into either a VIC 20 or the Commodore 64, and comes with all the instructions you will need to write your own terminal programs to utilize the automatic aspects.

A particularly attractive feature of the AUTOMODEM is of course its ability to automatically dial the phone number you select (with software). The modem uses pulse-dialing vice tone-dialing, however, so if you want to access almost any of the long-distance services, you will still have to use your telephone buttons to do so. This is the only real drawback to the AUTOMODEM I have been able to find, and for the price, I feel I can put up with a little button-pushing anyway! For my uses, the AUTOMODEM has worked out very well.

Since I do most of my telecommunicating with CompuServe, I use the autodial function quite often. As far as I know, all the node-numbers for accessing CompuServe are pulse or tone-dial capable, so you can use the modem with no problems to dial-up the service. The AUTOMODEM works equally well when accessing CompuServe or when calling a local database run by a microcomputer, since it fol-

lows appropriate standards for data-transfer over telephone lines. In fact, I can't remember ever getting garbage over the phone lines while using the new modem! This speaks well for a low-priced device, since one would expect minor problems with something that costs so little. Commodore has apparently made an effort to preclude this sort of problem with the new modem. Hopefully, the finished user manual for the AUTOMODEM will show equal care (I received a preliminary copy that seemed well-written, so I expect the manual will be readable.)

The AUTOMODEM plugs into the same port as the VICMODEM. As mentioned earlier, it's a little larger in width than a VICMODEM, but still presents a small package, thus avoiding clutter on your table. Even with the standard telephone plugged into the AUTOMODEM, there doesn't seem to be an inordinate amount of wire strung all over the table, which leaves more room for scribbling down those little notes we all use when we don't want to save a whole file.

There are three slide-switches on the AUTOMODEM. Two are mounted on the left side of its case (as you are facing the front of the computer with the modem plugged in), and one is located on the right side. The two on the left are for selecting Answer/Originate (A/O) and for selecting whether you want to use the telephone itself, or the modem (Data/Telephone). This is a nice feature if you want to use the telephone



without going into the other room! It will also prevent you from forgetting that the 64 is in automatic answer mode when you leave your desk. The tone put out by the AUTOMODEM (the carrier) is very loud, and will doubtless get you a few comments if your friends call and the 64 answers! Of course, you must remember to switch to "T" (telephone).

The switch on the right is for half or full duplex. Selecting full duplex prevents you from receiving your own typed-characters back except when echoed by the receiving computer. Some machines you might want to talk to may require half duplex, however, so CBM has included that option. Usually, the software (terminal program) will also allow you to select full or half duplex as well, but switch-selecting is much easier.

In addition to the three switches, there is a CARRIER-DETECT light on the front of the modem. When you are calling another computer and are in the originate mode, you will see this light come on (RED) when your 64 or VIC 20 has made contact with the other machine. If in the answer mode (someone else is calling you), then the light stays on at all times, since your machine is providing the carrier tone. If you autodial another computer and don't get the carrier detect light within a few seconds, usually that means the machine isn't answering (maybe it hasn't paid the bills??) or you got a busy signal. Make sure that your terminal software looks for the carrier-

detect, as it makes life much easier for you when you use the autodial functions.

In summation, I feel the AUTOMODEM is a fine product. Commodore has obviously taken pains to produce a good unit, and for that I am grateful. So many new machines and their peripherals are produced on the spur of the moment today with resultant deficiencies, so it's nice to see a piece of equipment done right! Of course the new AUTOMODEM may not be capable of all the "bells and whistles" of some of the higher-priced modems, but for the small cost of the AUTOMODEM, you get plenty!

C

## VIC 20™/COMMODORE 64™

**Investment Portfolio Manager** — for the Commodore 64 with disk drive or tape (printer optional), is menu driven and provides one summary page and nine detail pages. Each page can accept nine entries of up to \$99,999 each. The program can handle over \$8 million. The IPM is quick and makes it easy to track volatile assets such as stocks and stock options. The summary page displays the grand total and the per cent of grand total for each of nine investment categories. Price: \$14.95

**Disk Directory Manager** — for the VIC 20 or Commodore 64 with 1540/41 disk drive and 1525 printer. The DDM is a handy utility which will read directly from the directories of diskettes and sort into an ordered list, over 1500 file names, file sizes, file types and disk ID's; and print a hard copy master directory. It is written completely in fast and efficient machine language. Price: \$19.95

**Dungeons** — for the VIC 20 with 16k expansion and tape or disk. Create characters to explore a twelve level dungeon which contains 1200 individual rooms. After you purchase your weapon and armor, you will find vast treasures and do battle with over fifty types of monsters which you must slay for experience points. Your character also has the ability to cast numerous spells and you are given the option of saving the game to tape or disk as your character gains strength and experience. Excellent sound and three dimensional graphics add to the excitement. Price \$19.95

**Pak Alien** — for the unexpanded VIC 20 with tape or disk. 100% machine language arcade-style game. Custom graphic characters and 100 levels of increasing difficulty. Guide your alien through a maze of interplanetary space particles dodging the seven evil-alien and clear the board before the bonus timer runs out. Joystick or keyboard. Includes pause feature. Price: \$14.95

**BYTES and BITS**  
524 E. Canterbury Ln.  
Phoenix, AZ 85022

(602) 942-1475

Please specify tape or disk  
Add \$2.00 for postage  
and handling

VIC 20 and Commodore 64 are trademarks of Commodore Electronics Ltd.

## VIC-20™

### VIC-20 INTERFACING BLUE BOOK

Did you know that your VIC can be used to control a 99c toy motor so effectively that it runs like a precision machine? Or that you can build an accurate digital thermometer using the VIC and four parts costing less than \$5?

These and other 18 interfacing projects selected for usefulness, ease of construction and low cost are detailed in the VIC-20 Interfacing Blue Book, a veritable gold mine of practical information on how to build a variety of interfaces for your computer.

Projects include: Connecting VIC to your stereo; Pickproof digital lock; Capacitance meter; Liquid level sensor; Telephone dialer; Voice output; 8K/16K RAM/ROM expansion; 128K RAM expansion; 8-bit precision D/A; 8-bit A/D converter; MX-80 interface and more.

Written by a college professor in a friendly and informative style, the Blue Book gives you theory of operation, schematics, program listings, parts list, construction hints and sources of materials for each one of the 20 projects.

If you want to get the most out of your VIC this book is a must. Cost is \$14.95 (less than 75c per project!). Price includes postage.

VIC 20 is a trademark of Commodore Electronics Ltd.

**microsignal Dept C6**  
P.O. BOX 22  
MILLWOOD NY 10546

Please send me a copy of the Blue Book.

Enclosed my check for \$ \_\_\_\_\_

NAME \_\_\_\_\_

ADDRESS \_\_\_\_\_

Above prices include postage in the  
U.S. CA res. add 6% tax. Foreign add \$2.



# Commodore 64 Sprite Mover

by Elizabeth Deal

This article is for users of Commodore 64 systems. The program was tested on the PET and in versions one and two of the Commodore 64. The discussion of moving several sprites at a time presupposes your knowledge of the sprite chapters in the user's guide and the *Commodore 64 Programmer's Reference Guide*.

Moving sprites about the Commodore 64 screen is straightforward. The VIC chip keeps track of and rarely forgets the x and y coordinates of the sprite. Sprite coordinate registers are located at hex address VIC=\$D000 (53248 decimal). A pair of registers belongs to each sprite, first x then y. One more register is used, hex \$D010 (53264) to keep track of a part of the x-coordinate of all eight sprites together.

Specifically, the low byte of the x-coordinate goes in the pairs at \$D000, and if x is larger than 255 then a bit is set in the \$D010 location. Bits are numbered from right to left, zero to seven, like this:

bit#	7	6	5	4	3	2	1	0
hex value	80	40	20	10	8	4	2	1
decimal	128	64	32	16	8	4	2	1

If sprites three and five have x-coordinates exceeding 255 the pattern is:

bit#	7	6	5	4	3	2	1	0
	0	0	1	0	1	0	0	0

Since this register holds the data for all sprites, we have to carefully look at the register, change only the bit belonging to our sprite and put the value back.

No big deal, really. Let's first do it in BASIC for sprite number three, with the assumption, of course, that all other sprites are live and need protection. The key lines might look like this:

```
POKEVI+2*3,XAND255 enters low byte of x
POKEVI+16,PEEK(VI+16)AND(255-8) to turn
off a bit, and
POKEVI+16,PEEK(VI+16)OR8 to turn it on with-
out affecting other sprites.
```

This type of code is nicely explained and used in the *Programmer's Reference Guide* in several places, so I won't explain it any further. If you are not understanding what you are now reading it would be a very good idea to review the *Guide*. It is a book of great value.

## The Problem

The problem with this code is that it is sloooooow. For one or two hot air balloons BASIC is fine. But to move a space vehicle across the screen, the hot air balloon speed just won't do. And if you're defending the world from fast alien beings you may well have to hide instead.

Also, when a sprite crosses over the x=255 line in either direction, everything halts for a while until BASIC copies with the calculations. Finally, a sprite may flicker from one edge of the screen to another during the calculation, a slight annoyance.

## A Partial Solution

To remedy all this, we put the works in machine code. The code is the same, the flicker is probably there, but you won't see it happen. Honest.

Usually in this place most authors say, "And machine code, of course, runs several zillion times faster". Well, I cannot say it, because it does not. My luck! It runs much faster than BASIC and the motion is smoother, but it is not lightning speed at all, and the speed depends on the number of live sprites, which is still undesirable.

The reason is that BASIC, now somewhat slowed down by the presence of sprites on the screen, still controls the process. See the loop in lines 490-550 in the DEMO listing. For superfast motion we need to get out of BASIC altogether, or retain BASIC logic but move the sprites using the interrupts. But that's a whole other story.

In the meantime, what you are now getting is a subroutine that can be used as a building block. It is relocatable. It is self-contained. It can become a part of your sprite utilities. And it can be used in an interrupt-driven routine if you do the setup properly. You'll need to reserve some memory for sprite data:



the initial locations, frequency of changing the locations to keep the speed down (timers) and the distances to move. Revector the IRQ routine to point to your code, do JSR MOVER and it will move.

## Inputs to the Mover

The values that my routine needs are:

1. Sprite number, 0-7.
2. Direction of motion, coded.
3. How many pixels to move. Be reasonable, but 255 is OK; I'm not checking it.

See the coding protocol in lines 1100-1300 of the PAL listing and an example of use in lines 510-530 of the DEMO program. The direction values in the DEMO program are in a string V\$. That should keep us out of trouble with mixing DATA lines.

Note that the direction parameter is closely related to the joystick values, so that if your routine uses a joystick you have little to do but to enter the joystick position.

## Typing Instructions

1. Type only what is needed, according to what your computer has. SAVE what you typed before running it, since one tiny little mistake could crash the machine and you'd have to type all over again.
  - (1a) If you have an assembler such as PAL64 or the Commodore assembler, you can type (and improve) the source code from line 1000 down to 2080, making the necessary syntax adjustments. I believe that the only difference in the Commodore assembler is that you can only type one instruction per line, so make that change. Other assemblers may need to change some other syntax.
  - (1b) If you have SUPERMON64, the simplest thing is to type in lines 2120. Save the code, and you can move it yourself anytime to wherever you please by either an offset load routine of your own making or the SUPERMON's "T" (transfer) com-

mand. You'll need to reserve a hunk of safe memory. For that you can follow a pattern in the BASIC loader program, lines 150-240.

- (1c) If you have only BASIC in your 64, you have a tough job of crooked typing ahead. All the DATA lines up front need to be entered. But you get the benefit in that the loader will place the code and protect it from BASIC's harm at the top of the memory. It will check your typing: a checksum error will appear if there are errors. This isn't 100% foolproof, so verify your typing anyway. Otherwise a SYS address will announce itself, such as SYS 12345. If you have SAVED the DATA lines, you can now type NEW to get rid of the loader, or you can leave it in. It makes no difference.
2. Whichever way you pick, write down the starting address of the code, it may change daily, depending where you put it.
3. Enter this value into the DEMO program in line 620 where you now see illegal code AD= \*\*\*.
4. Run the DEMO by saying RUN 450. You'll see a bunch of cute zero-page sprites moving about. If you vary the number of active sprites in line 500 by changing the loop index you'll see a dramatic speed difference in motion.  
*(Note: These sprites are actually non-uniform block shapes.)*
5. Type Q to disable the sprites and quit.

## Fun Sprites

The sprites used in the DEMO listing are taken from the computer. They are fun to watch. Use of built-in sprites simplifies program writing.

You can do more. You can watch BASIC executing while the sprites are on the screen. A fun thing to do is to use the stop key to kill the program and retain the sprites on the screen. You'll see the displays change. Direct mode print commands and LIST request look pretty good. If you tap keys on the keyboard, this also will show up, so do your own thing and have fun.



# user departments:

Commodore 64

Try not to use tape while sprites are on the screen. It won't work. Disk works all right, but if sprites are in motion the motion will halt every once in a while. This is irrelevant to this article, but might be of some use to somebody.

If you do use a stop-key to see the sprites do their thing in direct mode, you can later cleanly disable them. Just type GOTO 570 after the show is over. You will not have to use the drastic measures of the restore key.

## Note to PET People

This code can be tested on the PET if you change all references to the VIC chip (\$D000) to some other place. When all the arithmetic is right, a final change to the VIC chip address is all that's necessary. **C**

1. PAL is an assembler written by Brad Templeton distributed by Pro-Line Software Ltd., Canada.
2. Commodore assembler is distributed by Commodore dealers.
3. SUPERMON64 is Jim Butterfield's monitor, in the public domain.

## Sprite Mover3

```
120 REM-----
130 REM SPRITE MOVER      ELIZABETH DEAL
140 REM-----
150 REM BASIC LOADER TO TOP OF MEMORY
160 TM=55:CS=0:READ SP,N$,CV
170 AD=PEEK(TM)+256*PEEK(TM+1)-SP-1
180 V%=AD/256:V=AD-256*V%
190 POKE TM,V:POKE TM+1,V%
200 POKE TM-4,V:POKE TM-3,V%
210 FOR I=0 TO SP:READ V:CS=CS+V
220 POKE AD+I,V:NEXT I
230 IF CS<>CV THEN PRINT"FIX[SPACE]DATA":END
240 PRINT N$":[SPACE]SYS"AD:END
250 DATA 125,"SPRITE[SPACE]MOVER",15816
260 DATA 166,170,165,171, 72,240,115,201
270 DATA 12,176,111,201, 3,240,107,224
280 DATA 8,176,103,138,168, 10,170, 70
290 DATA 171, 8,152, 72,144, 8,164,172
300 DATA 222, 1,208,136,208,250, 70,171
310 DATA 144, 8,164,172,254, 1,208,136
320 DATA 208,250,104,168, 40,240, 67, 56
330 DATA 169, 0, 42,136, 16,252,133,173
340 DATA 45, 16,208,240, 1,200,200, 70
350 DATA 171,144, 12,189, 0,208,229,172
360 DATA 157, 0,208,152,233, 0,168, 70
370 DATA 171,144, 13, 24,165,172,125, 0
380 DATA 208,157, 0,208,152,105, 0,168
390 DATA 152, 41, 1, 74,165,173, 73,255
400 DATA 45, 16,208,144, 2, 5,173,141
410 DATA 16,208,104,133,171, 96
```



```

420 :
430 REM---DEMO SPRITE MOVER-----
440 REM SEND 8 SPRITES IN 8 DIR
450 GOSUB 600:PRINT CHR$(152);:REM SETUP
455 PRINT"USE[SPACE]Q[SPACE]TO[SPACE]QUIT";
460 POKE VI+21,255 :REM ALL ENABLE
470 Z=35
480 IF PEEK(AD)*PEEK(AD+2)<>166*165 THEN STOP:***
490 FOR I=1 TO Z
495 GET I$:IF I$="Q"GOTO 570
500 FOR J=5 TO 7 :REM 0-7 OK
510 POKE Z1,J :REM SPRITE#
520 POKE Z2,DR(J+1-(J>=4)) :REM DIR
530 POKE Z3,2 :REM PIXELS
540 IF Z THEN SYS(AD) :REM MOVE IT
550 NEXT J,I
560 Z=0:GOTO 490: :REM SILLIES
570 POKE VI+21,0 :REM ALL DISABLE
580 END
590 REM---SETUP
600 V$="060210040008050109":K=0
610 FOR I=1 TO LEN(V$)STEP 2:K=K+1:DR(K)=VAL(MID$(V$,I,2))
: NEXT I
620 AD= *** :Z1=170:Z2=Z1+1:Z3=Z1+2
630 VI=13*4096 :REM VIC CHIP REG
640 POKE VI+33,0 :REM BLACK BACKGR
650 FOR I=0 TO 7
660 VV=2*I
670 POKE2040+I,I :REM Z-PAGE ETC SPR
680 POKEVI+VV,220 :REM X-COORD
690 POKEVI+VV+1,130:REM Y-COORD
700 POKEVI+39,15-I :REM ANY COLORS
710 NEXTI
720 POKEVI+23,255 :REM X EXPAND ALL
730 POKEVI+29,255 :REM Y EXPAND ALL
740 POKEVI+28,255 :REM ALL MULTICOLOR
750 POKEVI+37,6 :REM MCOL1
760 POKEVI+38,3 :REM MCOL2
770 POKEVI+16,0 :REM BEGIN ALL X<256
780 RETURN
790 :
1000 REM-----
1010 REM SYS700
1020 .OPT 00

```



# user departments:

Commodore 64

```
1040 ;
1050 ;C64 SPRITE MOVER  ELIZABETH DEAL
1060 ;
1070 ;PAL64 SOURCE
1080 ;CODE IS RELOCATABLE ANYPLACE
1090 ;
1100 ;BASIC POKES SPRITE#,DIRECTION,#PIXELS TO MOVE
1110 ;DIRECTION IS A 4-BIT VALUE RLDU
1120 ;SAME AS C64 JOYSTICK WITH BITS FLIPPED
1130 ;
1140 ;" 8421 <-- D      5  1  9
1150 ;" RLDU           \  /
1160 ;"               4- 0 -8
1170 ;"               /  \
1180 ;"               6  2 10
1190 ;
1200 ;MOVER CAN BE USED VIA INTERRUPT IF TIMING
1210 ;IS DONE IN ANOTHER ROUTINE AND
1220 ;SPRITE#,DIRECTION,DISTANCE ARE
1230 ;SET UP BEFORE CALLING THE MOVER
1240 ;
1250 ;THE BASIC CONNECTION
1260 ;" FORD=1TO9:READ DR(D):NEXTD
1270 ;" DATA 06,02,10,04,00,08,05,01,09
1280 ;" SN=4:D=3:MP=2:REM SPRITE #4,SOUTH-EAST,2PIXELS
1290 ;" POKEL70,SN:POKEL71,DR(D):POKEL73,MP:SYS MOVER
1300 ;
1310 ;---
1320 ;
1330 SN =$AA           ;SPRITE NUMBER 0-7
1340 DIR =SN+1        ;DIRECTION 0-15
1350 PIX =SN+2        ;PIXEL DIST <255
1360 MASK =SN+3       ;HOLDS 2^SN
1370 VIC =$D000       ;VIC CHIP C64
1380 ;
1390 ;---
1400 MOVER =*
1410 LDX SN:LDA DIR:PHA
1420 ;---CHECK SN,DIR PARAMETERS
1430 ; USER RESPONSIBLE FOR PIX
1440 BEQ EXIT1         ;LOOOONG JUMP
1450 CMP #$C:BCS EXIT1
1460 CMP #3:BEQ EXIT1
1470 CPX #8:BCS EXIT1
1480 ;---PARAMETERS OK
```



```

1490 TXA:TAY:ASL:TAX ;X=2*SN Y=SN
1500 ;---DO Y-COORDINATE
1510 LSR DIR:PHP
1520 TYA:PHA
1530 BCC DOWN
1540 LDY PIX
1550 U DEC VIC+1,X ;MOVE UP
1560 DEY:BNE U
1570 DOWN LSR DIR
1580 BCC YDONE
1590 LDY PIX
1600 D INC VIC+1,X ;MOVE DOWN
1610 DEY:BNE D
1620 YDONE =*
1630 PLA:TAY:PLP
1640 ;---DO X-COORDINATE
1650 HORIZ =*
1660 BEQ EXIT1 ;NO HORIZONTAL
1670 SEC ;DO 2^SPR#
1680 LDA #0 ; (THIS IS
1690 SETBIT ROL ; SLOW...BUT
1700 DEY ; RELOCATABLE)
1710 BPL SETBIT ;Y=$FF
1720 STA MASK ;KEEP RESULT
1730 AND VIC+$10 ;TEST IF HORIZ>255 NOW
1740 BEQ ZERO
1750 INY ;YES
1760 ZERO INY ;NO Y=HI BYTE X-COORD (0 OR 1)
1770 LSR DIR ;--TRY LEFT DIR
1780 BCC RIGHT
1790 LDA VIC,X
1800 SBC PIX
1810 STA VIC,X ;HORIZ-PIX, LOW BYTE
1820 TYA:SBC #0:TAY ; HI BYTE
1830 ;
1840 RIGHT LSR DIR ;--TRY RIGHT DIR
1850 BCC MSBX
1860 CLC:LDA PIX
1870 ADC VIC,X
1880 STA VIC,X ;HORIZ+PIX, LOW BYTE
1890 TYA:ADC #0:TAY ; HI BYTE
1900 ;
1910 MSBX =* ;--FIX HI-BYTE IN VIC+16, LIMIT 1
1920 TYA:AND #1:LSR ;SET CARRY BIT
1930 LDA MASK

```



# user departments:

Commodore 64

```
1940 EOR #$FF          ;FLIP 2^SN MASK
1950 AND VIC+$10      ;TURN OFF BIT SN
1960 BCC PUTBACK
1970 ORA MASK          ;ON IF NEEDED
1980 PUTBACK STA VIC+$10
1990 ;
2000 EXIT1 PLA:STA DIR ;MAY NEED IT
2010 RTS
2020 ;
2030 ;STATUS - A,Y,FLAGS UNDEFINED
2040 ;                X=2*SN
2050 ;                SN,DIR,PIX UNCHANGED
2060 ;                VIC X,Y SN POSITIONS UPDATED
2070 .END
2080 END
2090 REM-----
2100 REM MEMORY DUMP TO COPY ANYPLACE
2110 REM USING SUPERMON64
2120 SYS8
2130 "
2140 B*
2150 " PC SR AC XR YR SP
2160 .;0008 F0 00 08 A8 F6
2170 .M 7000 707E
2180 .:7000 A6 AA A5 AB 48 F0 73 C9
2190 .:7008 0C B0 6F C9 03 F0 6B E0
2200 .:7010 08 B0 67 8A A8 0A AA 46
2210 .:7018 AB 08 98 48 90 08 A4 AC
2220 .:7020 DE 01 D0 88 D0 FA 46 AB
2230 .:7028 90 08 A4 AC FE 01 D0 88
2240 .:7030 D0 FA 68 A8 28 F0 43 38
2250 .:7038 A9 00 2A 88 10 FC 85 AD
2260 .:7040 2D 10 D0 F0 01 C8 C8 46
2270 .:7048 AB 90 0C BD 00 D0 E5 AC
2280 .:7050 9D 00 D0 98 E9 00 A8 46
2290 .:7058 AB 90 0D 18 A5 AC 7D 00
2300 .:7060 D0 9D 00 D0 98 69 00 A8
2310 .:7068 98 29 01 4A A5 AD 49 FF
2320 .:7070 2D 10 D0 90 02 05 AD 8D
2330 .:7078 10 D0 68 85 AB 60 68 85
2340 .S"SPRITE MOVER",08,7000,707E DISK
2350 .S"SPRITE MOVER",01,7000,707E TAPE
2360 .X
2370 READY.
2380 ;-----
```



# Go Directly to XY!

by David Bull

*—Being a compendium of kludges, patches and subroutines all aimed at making up for the lack of a PRINT AT statement in Commodore BASIC. Some are short, some long, some quick, some slow. Perhaps one is right for your particular application. Routines are written for CBM/PET computers with 4.0 BASIC, but the technique applies to all Commodore computers.*

At some point in our programming adventures, every one of us using Commodore products may have been frustrated by the missing PRINT AT statement in CBM BASIC. This extension to the normal PRINT statement allows the programmer to specify the exact screen location at which data is to appear. The beginner may not notice its absence, as he is usually content using his "glass teletype", but for any non-trivial data display using PRINT statements, the AT is sorely missed.

Fortunately, PRINT AT is easily simulated. What is not quite so easy is finding the optimal solution. For one person the most important consideration is speed, whereas someone else may be more concerned with memory limitations.

Follow me, as I explore some of the alternative techniques.

In order to find the "best" solution, we will need some way to measure our attempts. I will use the program in Listing 1 as a test bed. It simply provides a framework in which we can insert each subroutine as we develop it, and then exercise that routine by making many calls to it. For a rough-and-ready reckoning of memory usage we will compare a FRE(0) value obtained after each test, with the value given by the test bed alone.

Note: throughout this article I will follow the convention—x = screen row, and y = screen column.

On with the show!

Let's start with everybody's favorite:

- home cursor
- print 'x-1' cursor down characters
- print 'y-1' cursor right characters
- print the data

Here's the simple subroutine to do this:

```
10 PRINT CHR$(19);
12 IF X<2 THEN 16
14 FOR Z=1 TO X-1:PRINT CHR$(17)
   ;:NEXT Z
16 IF Y<2 THEN 20
18 FOR Z=1 TO Y-1:PRINT CHR$(29)
   ;:NEXT Z
20 RETURN
```

Most versions I have seen in this routine forget the tests for skipping the loops, which otherwise are always executed, making it impossible to ever print on the top row or in the first column.

A typical call to use all our subroutines:

```
XXXX x=12 : y=24 : gosub10 : print
      "Hi mom!"
```

Time to run test/a . . . . . 252.64 seconds  
Bytes used over and above the testbed . . . . 115

Hmm... nice 'n easy, but not too fast. Our operator will get pretty bored waiting for a screenful of data to be positioned and printed at this speed. How about packing all that printing into one statement?

Somewhere at the beginning of our program we will need the initialization:

```
2 X$="":FOR INDEX=1 TO 24:X$=X$
  +CHR$(17):NEXT INDEX
3 Y$="":FOR INDEX=1 TO 79:Y$=Y$
  +CHR$(29):NEXT INDEX
```

To position the cursor the subroutine line will read:

```
10 PRINT CHR$(19);MID$(X$,1,X-1)
   ;MID$(Y$,1,Y-1);:RETURN
```



We use MID\$ rather than LEFT\$ because some older Commodore BASICs do not accept zero as a parameter for LEFT\$. Using MID\$ will avoid any problems.

Simple and short. How does it stack up?

Time to run test/b . . . . . 52.13 seconds  
Bytes used over and above the testbed . . . . . 247

Amazing! Six times faster. But... it cost us a lot of bytes. What about coding it in machine language? Can we improve on this speed, and perhaps save some memory?

```
., 03CA A9 13 LDA #13
., 03CC 20 66 F2 JSR $F266
., 03CF A9 11 LDA #11
., 03D1 AE EC 03 LDX $03EC
., 03D4 CA DEX
., 03D5 F0 06 BEQ $03DD
., 03D7 20 66 F2 JST $F266
., 03DA CA DEX
., 03DB D0 FA BNE $03D7
., 03DD A9 1D LDA #1D
., 03DF AE ED 03 LDX $03ED
., 03E2 CA DEX
., 03E3 F0 06 BEQ $03EB
., 03E5 20 66 F2 JSR $F266
., 03E8 CA DEX
., 03E9 D0 FA BNE $03E5
., 03EB 60 RTS
., 03EC XX ???
., 03ED XX ???
```

The memory locations given here for storage of this routine are in the second cassette buffer. The \$13 represents the "home cursor" character, the \$11 is the "cursor down", and the \$1D is the "cursor right". The jump to the ROM routine at \$F266 takes these characters and puts them on the screen. The x value must be POKEd into \$03EC and the y value into \$03ED before the routine is called. Once the machine language is in place in our machine, the command to use it is:

```
0 ON Z GOTO 100
1 Z=1:LOAD"0:XYLOCATE",08:REM
  XYLOCATE IS THE MACHINE LAN
  G. PORTION
10 POKE 1004,(X):POKE 1005,(Y)
   :SYS 970:RETURN
```

This routine assumes an intelligent use. It will not give coherent results if either x or y is given a "far-out" value.

Time to run test/c . . . . . 49.79 seconds  
Bytes used over and above the testbed . . . . . 52

Good... a bit faster and much more memory efficient (as the machine language in the cassette buffer is invisible to BASIC). But, come to think of it, how did that ROM routine keep track of where it was while it was putting things on the screen? Poring over some memory maps shows something interesting at locations 196, 197, and 198 (that's for BASIC 4.0 and upgrade ROMS. Use 224, 225, and 226 for original ROMS). 196/7 is the pointer to the screen RAM line. 198 is the position of the cursor on above line. Let's experiment a little bit in direct mode.

```
poke 196,0 : poke 197,128 : poke
198,28 : print "Hi mom!"
```

This statement should put the message about half-way along the top of the screen. How does it work?

The machine expects that the values placed in 196/7 will represent one of the memory locations in the video RAM section of memory, as shown in Figure 1.

The number in 198 is simply an offset, which will be added to this value to adjust the print position across the screen to the right.

So, how do we convert our x and y coordinates to these values? This subroutine should do it:



```

10 X = ((X-1)*80)+32768
12 MSB=INT(X/256)
14 LSB=X-(256*MSB)
16 POKE 196,(LSB):POKE 197,(MSB)
   :POKE 198,(Y-1)
18 RETURN

```

Line 10 converts x into the appropriate value from Figure 1. Lines 12 and 14 split that value into the two-byte format required by the 6502 processor. Voila! When a PRINT statement is executed the ROM routines will find the POKEd values and use them to position the message.

Time to run test/d . . . . . 73.58 seconds  
 Bytes used over and above the testbed . . . . . 124

Hmm... back to the drawing board... all that arithmetic must take time. What if we put *this* one into machine language?

```

., 03CA A9 00 LDA #$00
., 03CC 85 C4 STA $C4
., 03CE A9 80 LDA #$80
., 03D0 85 C5 STA $C5

```

```

., 03D2 A2 00 LDX #$00
., 03D4 F0 10 BEQ $03E6
., 03D6 18 CLC
., 03D7 A5 C4 LDA $C4
., 03D9 69 50 ADC #$50
., 03DB 85 C4 STA $C4
., 03DD A5 C5 LDA $C5
., 03DF 69 00 ADC #$00
., 03E1 85 C5 STA $C5
., 03E3 CA DEX
., 03E4 D0 F0 BNE $03D6
., 03E6 60 RTS

```

This routine takes our x value (which we must POKE into \$03D3 (decimal 979) before calling the routine) and uses it as a counter:

- put 32768 in locations 196/7
- if x = 0 then leave 196/7 alone and return
- \*—add '80' to value stored in locations 196/7
- decrement x (x = x-1)
- if x = 0 then quit (return)
- else loop back to \*

So, with the address of the appropriate row in 196/7, and with the y offset POKEd into 198, print statements will appear where desired. The sub-routine in BASIC:

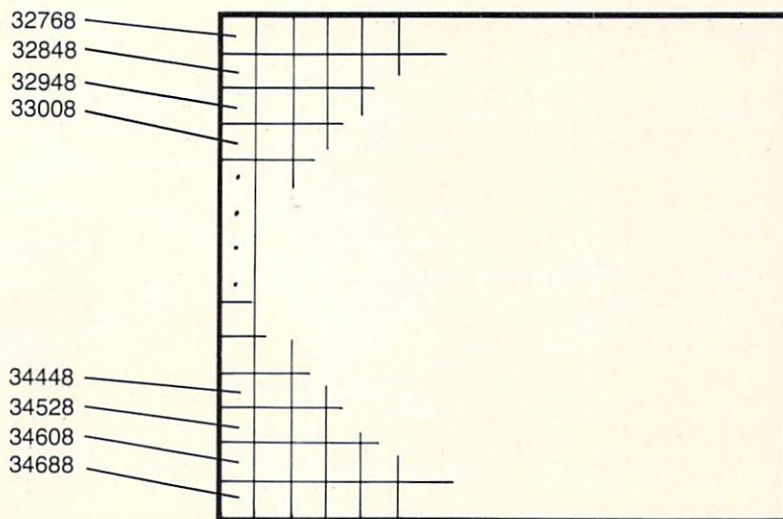

Figure 1.



```
0 ON Z GOTO 100
1 Z=1:LOAD"0:XYLOCATE/B",08:REM
  XYLOCATE/B IS THE MACH. L
  ANG. PORTION
10 POKE 979,(X-1):POKE 198,(Y-1)
  :SYS 970:RETURN
```

Time to run test/e ..... 43.68 seconds  
Bytes used over and above the testbed ..... 56

Now we're cooking with gas! But wait! Why are we fooling around like this? Think for a minute. How does the computer know where to print the \*\*\*COMMODORE BASIC\*\*\* message when it is first turned on? Surely, buried in all that ROM somewhere, there must be a routine for doing exactly what we want—preparing the cursor for printing. Back to the memory maps... aha! there it is! "Screen initialization"—\$E000. It turns out that deep in ROM there is a two-part table containing all those numbers from Figure 1. Our x value can be used as an offset to read the appropriate number from the table, which is then stored in those same locations that we used in test/d.

```
., E067 A6 D8 LDX $D8
., E069 4C 6F E0 JMP $E06F
```

## Testbed

```
5 GOTO 100 : REM START OF PROGRAM
6 :
10 REM
12 RETURN
50 :
100 PRINT CHR$(147);
110 T=TI
120 FOR INDEX = 1 TO 500
130 : X=INT(12*RND(0))+1
140 : Y=INT(80*RND(0))+1
150 : GOSUB 10 : PRINT "*";
155 : X=12:Y=13:GOSUB 10:PRINT
  INDEX" [SPACE] STARS [SPACE]
  PRINTED [SPACE] ";
160 NEXT INDEX
170 :
200 X=12:Y=13:GOSUB 10:PRINT "
  500 [SPACE] STARS [SPACE] PRINTED
  [SPACE] (GOTOXY [SPACE] 1000 [SPA
  CE] TIMES) [SPACE] IN [SPACE] ";
220 PRINT INT(((TI-T)/60)*100)
  /100;" [SPACE] SECONDS"
230 END
```

```
., E06C XX XX ???
., E06E XX ???
., E06F BD 55 E7 LDA $E755,X
., E072 85 C4 STA $C4
., E074 BD 6E E7 LDA $E76E,X
., E077 85 C5 STA $C5
., E079 60 RTS
```

So:

```
10 POKE 216,(X-1):POKE 198,
  (Y-1):SYS 57447:RETURN
```

These are the values for 80-column BASIC 4.0. Upgrade ROMs should use the same POKEs as this, while original ROMs will use 245 for x, and 226 for y. I don't have access to other ROM machines (or a 40-column 4.0) so I can't give you the SYS values for them. Perhaps someone will do a little digging in their machines and send them in.

Time to run test/f ..... 45.66 seconds  
Bytes used over and above the testbed ..... 40

The clear winner... extremely fast and memory efficient (thanks to that table).

So, PRINT AT was in there all the time! Ah well, it was fun anyway, and *most* instructive. **C**



# user groups

## User Group Listing

### ALABAMA

Huntsville PET Users Club  
9002 Berclair Road  
Huntsville, AL 35802  
Contact: Hal Carey  
Meetings: every 2nd  
Thursday  
Riverchase Commodore Users Group  
617 Grove St.  
Birmingham, AL 35209  
(205) 988-1078  
Ken Browning  
Wiregrass Micro-Computer Society  
Commodore SIG  
109 Key Bend Rd.  
Enterprise, AL 36330  
(205) 347-7564  
Bill Brown

### ALASKA

COMPOOH-T  
c/o Box 118  
Old Harbor, AK 99643  
(907) 286-2213

### ARIZONA

VIC Users Group  
2612 E. Covina  
Mesa, AZ 85203  
Contact: Paul Muffuletto  
Catalina Commodore Computer Club  
2012 Avenida Guillermo  
Tucson, AZ 85710  
(602) 296-6766  
George Pope  
1st Tues. 7:30 p.m.  
Central Arizona PET People  
842 W. Calle del Norte  
Chandler, AZ 85224  
(602) 899-3622  
Roy Schahrer  
ACUG  
c/o Home Computer Service  
2028 W. Camelback Rd.  
Phoenix, AZ 85015  
(602) 249-1186  
Dan Deacon  
First Wed. of month  
West Mesa VIC  
2351 S. Standage  
Mesa, AZ 85202  
Kenneth S. Epstein  
Arizona VIC 20-64 Users Club  
232 W. 9th Place North  
Mesa, AZ 85201  
Donald Kipp  
Arizona VIC & 64 Users  
904 W. Marlboro Circle  
Chandler, AZ 85224  
(602) 963-6149  
Tom Monson  
ARKANSAS  
Commodore/PET Users Club  
Conway Middle School  
Davis Street  
Conway, AR 72032  
Contact: Geneva Bowlin  
Booneville 64 Club  
c/o A. R. Hederich  
Elementary School  
401 W. 5th St.  
Booneville, AR 72927  
Mary Taff

The Siloam Commodore Computer Club  
P.O. Box 88  
Siloam Springs, AR 72761  
(501) 524-5624  
Ken Emanuelson  
Russellville Commodore User Group  
401 S. Arlington Dr.  
Russellville, AR 72801  
(501) 967-1868  
Bob Brazeal

### CALIFORNIA

SCPUG Southern California  
PET Users Group  
c/o Data Equipment Supply  
Corp.  
8315 Firestone Blvd.  
Downey, CA 90241  
(213) 923-9361  
Meetings: First Tuesday of  
each month  
California VIC Users Group  
c/o Data Equipment Supply  
Corp.  
8315 Firestone Blvd.  
Downey, CA 90241  
(213) 923-9361  
Meetings: Second Tues. of  
each month  
Valley Computer Club  
1913 Booth Road  
Ceres, CA 95307  
PUG of Silicon Valley  
22355 Rancho Ventura Road  
Cupertino, CA 95014  
Lincoln Computer Club  
750 E. Yosemite  
Manteca, CA 95336  
John Fung, Advisor  
PET on the Air  
525 Crestlake Drive  
San Francisco, CA 94132  
Max J. Babin, Secretary  
PALS (Pets Around)  
Livermore Society  
886 South K  
Livermore, CA 94550  
(415) 449-1084  
Every third Wednesday  
7:30 p.m.  
Contact: J. Johnson  
SPHINX  
7615 Levison Ave.  
El Cerrito, CA 94530  
(415) 527-9286  
Bill MacCracken  
San Diego PUG  
c/o D. Costarakis  
3562 Union Street  
(714) 235-7626  
7 a.m.-4 p.m.  
Walnut Creek PET  
Users Club  
1815 Ygnacio Valley  
Road  
Walnut Creek, CA 94596  
Jurupa Wizards  
8700 Galena St.  
Riverside, CA 92509  
781-1731  
Walter J. Scott  
The Commodore Connection  
2301 Mission St.  
Santa Cruz, CA 95060  
(408) 425-8054  
Bud Massey  
San Fernando Valley  
Commodore Users Group  
21208 Nashville  
Chatsworth, CA 91311  
(213) 709-4736  
Tom Lynch  
2nd Wed. 7:30  
VACUUM  
277 E. 10th Ave.  
Chico, CA 95926  
(916) 891-8085  
Mike Casella  
2nd Monday of month  
VIC 20 Users Group  
2791 McBride Ln. #121  
Santa Rosa, CA  
(707) 575-9836  
Tyson Verse  
South Bay Commodore Users Group  
1402 W. 218th St.  
Torrance, CA 90501  
Contact: Earl Evans  
Slo VIC 20/64 Computer Club  
1766 9th St.  
Los Osos, CA  
The Diamond Bar R.O.P. Users Club  
2644 Amelgado  
Haciendo Hgts., CA 91745  
(213) 333-2645  
Don McIntosh  
Commodore Interest Association  
c/o Computer Data  
14660 La Paz Dr.  
Victorville, CA 92392  
Mark Finley  
Fairfield VIC 20 Club  
1336 McKinley St.  
Fairfield, CA 94533  
(707) 427-0143  
Al Brewer  
1st & 3rd Tues. at 7 p.m.  
Computer Barn Computer Club  
319 Main St.  
Suite #2  
Salinas, CA 93901  
757-0788  
S. Mark Vanderbilt  
Humboldt Commodore Group  
P.O. Box 570  
Arcata, CA 95521  
R. Turner  
Napa Valley Commodore  
Computer Club  
c/o Liberty Computerware  
2680 Jefferson St.  
Napa, CA 94558  
(707) 252-6281  
Mick Winter  
1st & 3rd Mon. of month  
S.D. East County C-64 User Group  
6353 Lake Apopka Place  
San Diego, CA 92119  
(619) 698-7814  
Linda Schwartz  
Commodore Users Group  
4237 Pulmeria Ct.  
Santa Maria, CA 93455  
(805) 937-4174  
Gilbert Vela

Bay Area Home Computer Asso.  
Walnut Creek Group  
1406 N. Broadway at Cypress  
Walnut Creek, CA 94596  
Wil Cossel  
Sat. 11 a.m. to 3 p.m.  
Amateurs and Artesians Computing  
P.O. Box 682  
Cobb, CA 95426  
Manteca VIC 20 Users Organization  
429 N. Main St.  
Manteca, CA 95336  
Gene Rong  
Pomona Valley Vic Users Group  
1401 W. 9th, #77  
Pomona, CA 91766  
(714) 620-8889  
Mark Joerger  
1st & 3rd Wed. of month 7 p.m.  
20/64 Users Group  
P.O. Box 18473  
San Jose, CA 95158  
Don Cracraft  
1st Sunday, 6 p.m., Mercury Sav  
VIC TORII-The VIC 20 Users Group  
PSC #1, Box 23467  
APO San Francisco, CA 96230  
Wesley Clark  
The Valley Computer Club  
2006 Magnolia Blvd.  
Burbank, CA 91506  
1st Wed. 7 p.m.  
The Commodore Tech. Users  
of Orange Co.  
P.O. Box 1497  
Costa Mesa, CA 92626  
(714) 731-5195  
Roger Fisher  
VIC 20 Software Exchange Club  
10530 Sky Circle  
Grass Valley, CA 95945  
Daniel Upton  
C-64 West Orange County Users Group  
P.O. Box 1457  
Huntington Beach, CA 92647  
(714) 842-4484  
Philip Putman  
2nd & 4th Tues. of month  
Antelope Valley Commodore Users Group  
POB 4436  
Lancaster, CA 93539  
(805) 942-2626  
James Haner  
1st Saturday  
Diablo Valley Commodore Users Group  
762 Ruth Dr.  
Pleasant Hill, CA 94523  
(415) 671-0145  
Ben Braver  
2nd & 4th Thurs. 7:30 p.m.  
Commodore Connection  
11652 Valverde Ave.  
Riverside, CA 92505  
(714) 689-7447  
Tony Alvarez  
CA. Area Commodore Terminal  
Users Society  
C.A.C.T.U.S.  
P.O. Box 1277  
Alta Loma, CA 91701  
Darrell Hall



# user groups

20/64  
P.O. Box 18473  
San Jose, CA 95158  
(408) 978-0546  
1st Sun. of month (6-9 p.m.)  
8120 Sundance Dr.  
Orangevale, CA 95662  
(916) 969-2028  
Robyn Graves

## COLORADO

VICKIMPET Users Group  
4 Waring Lane, Greenwood  
Village  
Littleton, CO 80121  
Contact: Louis Roehrs  
Colorado Commodore Computer Club  
2187 S. Golden Ct.  
Denver, CO 80227  
986-0577  
Jack Moss  
Meet: 2nd Wed.

## CONNECTICUT

John F. Garbarino  
Skiff Lane Masons Island  
Mystic, CT 06355  
(203) 536-9789  
Commodore User Club  
Wethersfield High School  
411 Wolcott Hill Road  
Wethersfield, CT 06109  
Contact: Daniel G. Spaneas

VIC Users Club  
c/o Edward Barszczewski  
22 Tunxis Road  
West Hartford, CT 06107

New London County  
Commodore Club  
Doolittle Road  
Preston, CT 06360  
Contact: Dr. Walter Doolittle

## FLORIDA

Jacksonville Area  
PET Society  
401 Monument Road, #177  
Jacksonville, FL 32211

Richard Prestien  
6278 SW 14th Street  
Miami, FL 33144

South Florida  
PET Users Group  
Dave Young  
7170 S.W. 11th  
West Hollywood, FL 33023  
(305) 987-6982

PETs and Friends  
129 NE 44 St.  
Miami, FL 33137

Richard Plumer  
Sun Coast VICs  
P.O. Box 1042  
Indian Rocks Beach, FL  
33535

Mark Weddell  
Bay Commodore Users  
Group  
c/o Gulf Coast Computer  
Exchange  
241 N. Tyndall Pkwy.  
P.O. Box 6215  
Panama City, FL 32401  
(904) 785-6441

Richard Scofield  
Gainesville Commodore  
Users Club  
3604-20A SW 31st Dr.  
Gainesville, FL 32608  
Louis Wallace  
64 Users Group  
P.O. Box 561689  
Miami, FL 33156  
(305) 274-3501  
Eydie Sloane

Brandon Users Group  
108 Anglewood Dr.  
Brandon, FL 33511  
(813) 685-5138  
Paul Daugherty

Brandon Commodore Users Group  
414 E. Lumsden Rd.  
Brandon, FL 33511  
Gainesville Commodore Users Group  
Santa Fe Community College  
Gainesville, FL 32602  
James E. Birdsell

Commodore Computer Club  
P.O. Box 21138  
St. Petersburg, FL 33742

Commodore Users Group  
545 E. Park Ave.  
Apt. #2  
Tallahassee, FL 32301  
(904) 224-6286  
Jim Neill

The Commodore Connection  
P.O. Box 6684  
West Palm Beach, FL 33405

El Shift OH  
P.O. Box 548  
Cocoa, FL 32922  
Mike Schnoke  
Sat. mornings/every 4 to 6 weeks

Miami 20/64  
12911 S.W. 49th St.  
Miami, FL 33175  
(305) 226-1185

Tampa Bay Commodore Computer Club  
10208 N. 30th St.  
Tampa, FL 33612  
(813) 977-0877

## GEORGIA

VIC Educators Users Group  
Cherokee County Schools  
110 Academy St.  
Canton, GA 30114  
Dr. Al Evans

Bldg. 68, FLETC  
Glynco, GA 31524  
Richard L. Young

VIC-tims  
P.O. Box 467052  
Atlanta, GA 30346  
(404) 922-7088  
Eric Ellison

Golden Isles Commodore Users Club  
Bldg. 68, FLETC  
Glynco, GA 31524  
Richard L. Young

## HAWAII

Commodore Users Group of Honolulu  
c/o PSH  
824 Bannister St.

Honolulu, HI  
(808) 848-2088  
3rd Fri. every month

20/64 Hawaii  
P.O. Box 966  
Kailua, HI 96734  
Wes Goodpaster  
Commodore Users Group of Honolulu  
1626 Wilder #701  
Honolulu, HI 96822  
(808) 848-2088  
Jay Calvin (808) 944-9380

## IDAHO

GHS Computer Club  
c/o Grangeville High School  
910 S. D St.  
Grangeville, ID 83530  
Don Kissinger

S.R.H.S. Computer Club  
c/o Salmon River H.S.  
Riggins, ID 83549  
Barney Foster

Commodore Users  
548 E. Center  
Pocatello, ID 83201  
(208) 233-0670  
Leroy Jones

Eagle Rock Commodore Users Group  
900 S. Emerson  
Idaho Falls, ID 83401  
Nancy J. Picker

## ILLINOIS

Shelly Wernikoff  
2731 N. Milwaukee  
Avenue  
Chicago, IL 60647

VIC 20/64 Users Support  
Group  
c/o David R. Tarvin  
114 S. Clark Street  
Pana, IL 62557  
(217) 562-4568

Central Illinois PET User  
Group  
635 Maple  
Mt. Zion, IL 62549  
(217) 864-5320

Contact: Jim Oldfield  
ASM/TED User Group  
200 S. Century  
Rantoul, IL 61866  
(217) 893-4577

Contact: Brant Anderson  
PET VIC Club (PVC)  
40 S. Lincoln  
Mundelein, IL 60060  
Contact: Paul Schmidt,  
President

Rockford Area PET Users  
Group  
1608 Benton Street  
Rockford, IL 61107

Commodore Users Club  
1707 East Main St.  
Olney, IL 62450  
Contact: David E. Lawless

VIC Chicago Club  
3822 N. Bell Ave.  
Chicago, IL 60618  
John L. Rosengarten

Chicago Commodore 64  
Users & Exchange Group  
P.O. Box 14233  
Chicago, IL 60614  
Jim Robinson

Fox Valley PET Users  
Group  
833 Willow St.  
Lake in the Hills, IL 60102  
(312) 658-7321  
Art DeKneef

The Commodore 64 Users  
Group  
P.O. Box 572  
Glen Ellyn, IL 60137  
(312) 790-4320  
Gus Pagnotta

RAP 64/VIC Regional  
Assoc. of Programmers  
10721 S. Lamont  
Oak Lawn, IL 60453  
Bob Hughes

The Kankakee Hackers  
RR #1, Box 279  
St. Anne, IL 60964  
(815) 933-4407  
Rich Westerman

WIPUG  
Rt. 5, Box 75  
Quincy, IL 62301  
(217) 656-3671  
Edward Mills

## INDIANA

PET/64 Users  
10136 E. 96th St.  
Indianapolis, IN 46256  
(317) 842-6353  
Jerry Brinson

Cardinal Sales  
6225 Coffman Road  
Indianapolis, IN 46268  
(317) 298-9650  
Contact: Carol Wheeler

CHUG (Commodore  
Hardware Users Group)  
12104 Meadow Lane  
Oakland, IN 46236  
Contact: Ted Powell

VIC Indy Club  
P.O. Box 11543  
Indianapolis, IN 46201  
(317) 898-8023  
Ken Ralston

Northern Indiana  
Commodore Enthusiasts  
927 S. 26th St.  
South Bend, IN 46615  
Eric R. Bean

Commodore Users Group  
1020 Michigan Ave.  
Logansport, IN 46947  
(219) 722-5205  
Mark Bender

Computer Workshop VIC 20/64 Club  
282 S. 600 W.  
Hebron, IN 46341  
(219) 898-4535  
Mary O'Bringer  
The National Science Clubs  
of America  
Commodore Users Division



7704 Taft St.  
Merrillville, IN 46410  
Brian Lepley or Tom Vlasic  
East Central Indiana VIC User Group  
Rural Route #2  
Portland, IN 47371  
Stephen Erwin  
National VIC 20 Program Exchange  
102 Hickory Court  
Portland, IN 47371  
(219) 726-4202  
Stephen Erwin  
Commodore Computer Club  
3814 Terra Trace  
Evansville, IN 47711  
(812) 477-0739  
John Patrick, President  
Commodore 64 Users Group  
912 South Brown Ave.  
Terre Haute, IN 47803  
(812) 234-5099  
Dennis Graham

#### IOWA

Commodore User Group  
114 8th St.  
Ames, IA 50010  
Quad City Commodore Club  
1721 Grant St.  
Bettendorf, IA 52722  
(319) 355-2641  
John Yigas  
Commodore Users Group  
965 2nd St.  
Marion, IA 52302  
(319) 377-5506  
Vern Rotert  
3rd Sun. of month  
Siouxland Commodore Club  
2700 Sheridan St.  
Sioux City, IA 51104  
(712) 258-7903  
Gary Johnson  
1st & 3rd Monday of month  
421 W. 6th St.  
Waterloo, IA 50702  
(319) 232-1062  
Frederick Volker  
Commodore Computer Users  
Group of Iowa  
Box 3140  
Des Moines, IA 50316  
(515) 263-0963 or (515) 287-1378  
Laura Miller

#### KANSAS

Wichita Area PET  
Users Group  
2231 Bullinger  
Wichita, KS 67204  
(316) 838-0518  
Contact: Mel Zandler  
Kansas Commodore  
Computer Club  
101 S. Burch  
Olathe, KS 66061  
Contact: Paul B. Howard  
Commodore Users Group  
6050 S. 183 St. West  
Viola, KS 67149  
Walter Lounsbury  
Walnut Valley Commodore User Group  
1003 S. 2nd St.

Arkansas City, KS 67005  
Bob Morris

#### KENTUCKY

VIC Connection  
1010 S. Elm  
Henderson, KY 42420  
Jim Kemp  
Louisville Users of Commodore KY.  
(LUCKY)  
c/o Computer Showroom  
1247 Hurstbourne  
Louisville, KY 40222  
2nd Monday

#### LOUISIANA

Franklin Parish Computer  
Club  
#3 Fair Ave.  
Winnisboro, LA 71295  
James D. Mays, Sr.  
NOVA  
917 Gordon St.  
New Orleans, LA 70117  
(504) 948-7643  
Kenneth McGruder, Sr.  
VIC 20 Users Group  
5064 Bowdon St.  
Marrero, LA 70072  
(504) 341-5305  
Wayne D. Lowery, R.N.  
64-Club News  
5551 Corporate Blvd.  
Suite 3L  
Baton Rouge, LA 70808  
(504) 766-7408  
Tom Parsons  
3rd Tues. of month at CWA  
Commodore Users Group of Oachita  
P.O. Box 175  
Swaric, LA 71281  
(318) 343-8044  
Beckie Walker

#### MARYLAND

Assoc. of Personal  
Computer Users  
5014 Rodman Road  
Bethesda, MD 20016  
Blue TUSK  
700 East Joppa Road  
Baltimore, MD 21204  
Contact: Jim Hauff  
House of Commodore  
8835 Satyr Hill Road  
Baltimore, MD 21234  
Contact: Ernest J. Fischer  
Long Lines Computer Club  
323 N. Charles St., Rm. 201  
Baltimore, MD 21201  
Gene Moff  
VIC & 64 Users Group  
The Boyds Connection  
21000 Clarksburg Rd.  
Boys, MD 20841  
(301) 428-3174  
Tom DeReggi  
VIC 20 Users Group  
23 Coventry Lane  
Hagerstown, MD 21740  
Joseph Rutkowski  
Hagerstown Users Group  
1201-B Marshall St.

Hagerstown, MD 21740  
(301) 790-0968  
Greg Stewart  
1st & 3rd Friday of month 6:30 p.m.  
Rockville VIC/64 Users Group  
5112 Parklawn Terrace  
Apt. #103  
Rockville, MD 20853  
(301) 231-7823  
Tom Pounds  
The Compucats' Commodore  
Computer Club  
680 W. Bel Air Ave.  
Aberdeen, MD 21001  
(301) 272-0472  
Betty Jane Schueler  
Westinghouse BWI  
Commodore User Group  
Attn: L. Barron Mail Stop 5156  
P.O. Box 1693  
Baltimore, MD 21203

#### MASSACHUSETTS

Eastern Massachusetts  
VIC Users Group  
c/o Frank Ordway  
7 Flagg Road  
Marlboro, MA 02173  
VIC Users Group  
c/o Ilene Hoffman-Sholar  
193 Garden St.  
Needham, MA 02192  
Commodore Users Club  
Stoughton High School  
Stoughton, MA 02072  
Contact: Mike Lennon  
Berkshire PET Lovers  
CBM Users Group  
Taconic High  
Pittsfield, MA 01201  
The Boston Computer  
Society  
Three Center Plaza  
Boston, MA 02108  
(617) 367-8080  
Mary E. McCann  
Masspet Commodore Users Group  
P.O. Box 307  
East Taunton, MA 02718  
David Rogers  
Raytheon Commodore Users Group  
Raytheon Company  
Hartwell Rd. GRA-6  
Bedford, MA 01730  
John Rudy  
Commodore 64 Users  
Group of The Berkshires  
184 Highland Ave.  
Pittsfield, MA 01201  
Ed Rucinski  
VIC Interface Club  
48 Van Cliff Ave.  
Brockton, MA 02401  
Bernie Robichaud  
Cape Cod 64 Users Group  
358 Forrest Rd.  
S. Yarmouth, MA 02664  
1 (800) 225-7136  
Jim Close  
(In MA. call) 1 (800) 352-7787

#### MICHIGAN

David Liem  
14361 Warwick Street  
Detroit, MI 48223  
VIC Users Club  
University of Michigan  
School of Public Health  
Ann Arbor, MI 48109  
Contact: John Gannon  
Commodore User Club  
32303 Columbus Drive  
Warren, MI 48093  
Contact: Robert Steinbrecher  
Commodore Users Group  
c/o Family Computer  
3947 W. 12 Mile Rd.  
Berkley, MI 48072  
VIC for Business  
6027 Orchard Ct.  
Lansing, MI 48910  
Mike Marotta  
South Computer Club  
South Jr. High School  
45201 Owen  
Belleville, MI 48111  
Ronald Ruppert  
Commodore Users Group  
c/o Eaton Rapids Medical Clinic  
101 Spicerville Hwy.  
Eaton Rapids, MI 48827  
Albert Meinke III, M.D.  
South East Michigan Pet  
Users Group  
Box 214  
Farmington, MI 48024  
Norm Eisenberg  
Commodore Computer Club  
4106 Eastman Rd.  
Midland, MI 48640  
(517) 835-5130  
John Walley  
9:30 p.m. Sept/May  
VIC, 64, PET Users Group  
8439 Arlis Rd.  
Union Lake, MI 48085  
363-8539  
Bert Searing  
VIC Commodore User Club  
486 Michigan Ave.  
Mariesville, MI 48040  
(313) 364-6804  
M. Gauthier  
ComputerTowne  
35171 Grand River  
Farmington, MI 48024  
(313) 471-4216  
Ann Arbor Commodore Users Group  
Ann Arbor, MI 48103  
(313) 994-4751  
Art Shaw  
3rd Tues. 7:30-10:00  
DAB Computer Club  
P.O. Box 542  
Watervliet, MI 49098  
(616) 463-5457  
Dennis Burlingham  
West Michigan Commodores  
c/o R. Taber  
1952 Cleveland Ave., S.W.  
Wyoming, MI 49509  
(616) 458-9724  
Gene Traas



# user groups

## MINNESOTA

MUPET (Minnesota Users of PET)  
P.O. Box 179  
Annandale, MN 55302  
c/o Jon T. Minerich  
Twin Cities Commodore Computer Club  
6623 Ives Lane  
Maple Grove, MN 55369  
(612) 424-2425  
Contact: Rollie Schmidt

## MISSISSIPPI

Commodore Biloxi User Group (ComBUG)  
Universal Computer Services  
3002 Hwy. 90 East  
Ocean Springs, MS 39564  
(601) 875-1173  
John Lassen

## MISSOURI

KCPUG  
5214 Blue Ridge Boulevard  
Kansas City, MO 64133  
Contact: Rick West  
(816) 356-2382  
Commodore User Group of St. Louis  
Box 6653  
St. Louis, MO 63125-0653  
Dan Weidman, New Members  
1541 Swallowtail Dr.  
St. Louis, MO  
VIC INFONET  
P.O. Box 1069  
Branson, MO 65616  
(417) 334-6099  
Jory Sherman  
Worth County PET Users Group  
Grant City, MO  
(816) 564-3551  
David Hardy  
Mid-Missouri Commodore Club  
1804 Vandiver Dr.  
Columbia, MO 65201  
(314) 474-4511  
Phil Bishop  
Joplin Commodore Computers Users Group  
422 S. Florida Ave.  
Joplin, MO 64801  
R. D. Connelly

## MONTANA

Powder River Computer Club  
Powder River County High School  
Broadus, MT 59317  
Contact: Jim Sampson  
Commodore User Club  
1109 West Broadway  
Butte, MT 59701  
Contact: Mike McCarthy

## NEBRASKA

Greater Omaha Commodore 64 Users Group  
2932 Leewood Dr.  
Omaha, NE 68123  
(402) 292-2753  
Bob Quisenberry

## NEVADA

Las Vegas PET Users  
Suite 5-315  
5130 E. Charleston Blvd.  
Las Vegas, NV 89122  
Gerald Hasty

## NEW JERSEY

Commodore Friendly User Group  
49 Hershey Rd.  
Wayne, NJ 07470  
(201) 696-8043  
Rich Pinto/Colin Campbell  
Somerset Users Club  
49 Marcy Street  
Somerset, NJ 08873  
Contact: Robert Holzer  
Educators Advisory  
P.O. Box 186  
Medford, NJ 08055  
(609) 953-1200  
John Handfield  
VIC-TIMES  
46 Wayne Street  
Edison, NJ 08817  
Thomas R. Molnar  
VIC 20 User Group  
67 Distler Ave.  
W. Caldwell, NJ 07006  
(201) 284-2281  
G. M. Amin  
VIC Software Development Club  
77 Fomalhaut Ave.  
Sewell, NJ 08080  
H. P. Rosenberg  
ACGNJ PET/VIC/CBM User Group  
30 Riverview Terr.  
Belle Mead, NJ 08502  
(201) 359-3862  
J. M. Pylika  
South Jersey Commodore Computer Users Club  
46-B Monroe Park  
Maple Shade, NJ 08052  
(609) 667-9758  
Mark Orthner  
2nd Fri. of month  
Parsippany Computer Group  
51 Ferncliff Rd.  
Morris Plains, NJ 07950  
(201) 267-5231  
Bob Searing

## NEW HAMPSHIRE

Northern New England Computer Society  
P.O. Box 69  
Berlin, NH 03570  
TBH VIC-NICs  
P.O. Box 981  
Salem, NH 03079  
C-64 U.S.E.R.S. User Software Exchange Pro  
P.O. Box 4022  
Rochester, NH 03867  
Paul Kyle

## NEW MEXICO

Commodore Users Group  
6212 Karlson, NE  
Albuquerque, NM 87113  
(505) 821-5812  
Danny Byrne

## NEW YORK

Capital District 64/VIC 20 Users Group  
363 Hamilton St.  
Albany, NY 12210  
(518) 436-1190  
Bill Pizer  
Long Island PET Society  
Ralph Bressler  
Harborfields HS  
Taylor Avenue  
Greenlawn, NY 11740  
PET User Club of Westchester  
P.O. Box 1280  
White Plains, NY 10602  
Contact: Ben Meyer  
LIVE (Long Island VIC Enthusiasts)  
17 Picadilly Road  
Great Neck, NY 11023  
Contact: Arnold Friedman  
Commodore Masters  
25 Croton Ave.  
Staten Island, NY 10301  
Contact: Stephen Farkouh  
VIC Users Club  
76 Radford St.  
Staten Island, NY 10314  
Contact: Michael Frantz  
West Chester County VIC Users Group  
P.O. Box 146  
Pelham, NY 10552  
Joe Brown  
SPUG  
4782 Boston Post Rd.  
Pelham, NY 10803  
Paul Skipski  
VIC 20 User Club  
151-28 22nd Ave.  
Whitestone, NY 11357  
Jean F. Coppola  
VIC 20 User Club  
339 Park Ave.  
Babylon, NY 11702  
(516) 669-9126  
Gary Overman  
VIC User Group  
1250 Ocean Ave.  
Brooklyn, NY 11230  
(212) 859-3030  
Dr. Levitt  
L&M Computer Club  
VIC 20 & 64  
4 Clinton St.  
Tully, NY 13159  
(315) 696-8904  
Dick Mickelson  
Commodore Users Group  
1 Corwin Pl.  
Lake Katrine, NY 12449  
J. Richard Wright  
VIC 20/Commodore 64 Users Group  
31 Maple Dr.  
Lindenhurst, NY 11757  
(516) 957-1512  
Pete Lobol  
VIC Information Exchange Club

336 W. 23 St.  
Deer Park, NY 11729  
Tom Schlegel  
SASE & phone please  
New York Commodore Users Group  
380 Riverside Dr., 7Q  
New York, NY 10025  
(212) 566-6250  
Ben Tunkelang  
Hudson Valley Commodore Club  
1 Manor Dr.  
Woodstock, NY 12498  
F.S. Goh  
1st Wednesday of month  
LIVICS (Long Island VIC Society)  
20 Spyglass Lane  
East Setauket, NY 11733  
(516) 751-7844  
Lawrence Stefani  
VIC Users Group  
c/o Stoney Brook Learning Center  
1424 Stoney Brook Rd.  
Stoney Brook, NY 11790  
(516) 751-1719  
Robert Wurtzel  
Poughkeepsie VIC User Group  
2 Brooklands Farm Rd.  
Poughkeepsie, NY 12601  
(914) 462-4518  
Joe Steinman  
VIC 20 User Group  
Paper Service Division  
Kodak Park  
Rochester, NY 14617  
David Upham, Sr.  
Manhattan 64  
426 West 48th  
New York, NY 10036  
(212) 307-6519  
Charles Honce  
Adirondack Commodore 64 Users Group  
205 Woodlawn Ave.  
Saratoga Springs, NY  
(518) 584-8960  
Paul Klompas  
Rockland County Commodore Users Group  
P.O. Box 573  
Nanuet, NY 10965  
Ross Garber  
New York 64 Users Group  
222 Thompson St.  
New York, NY 10012  
(212) 673-7241  
Bruce Cohen  
Finger Lakes Commodore Users Group  
c/o Rose City Computer Associates  
229 West Union St.  
Newark, NY 14513  
(315) 331-1185  
The Commodore Users Group Rochester  
78 Hardison Rd.  
Rochester, NY 14617  
(716) 544-5251  
Tom Werenski  
Phone Evenings between 7-10  
**NORTH CAROLINA**  
Amateur Radio PET Users Group  
P.O. Box 30694  
Raleigh, NC 27622



Contact: Hank Roth  
VIC Users Club  
c/o David C. Fonenberry  
Route 3, Box 351  
Lincolnton, NC 28092  
Microcomputer Users Club  
Box 17142 Bethabara Sta.  
Winston-Salem, NC 27116  
Joel D. Brown  
VIC Users Club  
Rt. 11, Box 686  
Hickory, NC 28601  
Tim Gromlovits  
Raleigh VIC 20/64 Users Group  
410-D Delta Court  
Cary, NC 27511  
(919) 469-3862  
Larry Diener

#### OHIO

Dayton Area PET  
User Group  
933 Livingston Drive  
Xenia, OH 45385  
B. Worby, President  
(513) 848-2065  
J. Watson, Secretary  
(513) 372-2052  
Central Ohio PET  
Users Group  
107 S. Westmoor Avenue  
Columbus, OH 43204  
(614) 274-0304  
Contact: Philip H. Lynch  
Commodore Computer Club of Toledo  
734 Donna Drive  
Temperance, MI 48182  
Gerald Carter  
Chillicothe Commodore  
Users Group  
P.O. Box 211  
Chillicothe, OH 45601  
William A. Chaney  
Licking County 64 Users Group  
323 Schuler St.  
Newark, OH 43055  
(614) 345-1327  
11433 Pearl Rd.  
Strongsville, OH 44136  
Paul M. Warner  
C.P.U. Connection  
P.O. Box 42032  
Brook Park, OH 44142  
Danni Hudak  
Commodore Users Group  
18813 Harlan Dr.  
Maple Heights, OH 44137  
(216) 581-3099  
Carl Skala  
Commodore Users  
of Blue Chip (Cincinnati)  
816 Beecher St.  
Cincinnati, OH 45206  
(513) 961-6582  
Ted Stalets  
**OKLAHOMA**  
Southwest Oklahoma  
Computer Club  
c/o Commodore Chapter  
P.O. Box 6646  
Lawton, OK 73504  
1:30 at Lawton City Library

Tulsa Area Commodore Users Group  
Tulsa Computer Society  
P.O. Box 15238  
Tulsa, OK 74112  
Annette Hinshaw  
Commodore Oklahoma Users Club  
4000 NW 14th St.  
Oklahoma City, OK 73107  
(405) 943-1370  
Stanley B. Dow  
Commodore Users  
Box 268  
Oklahoma City, OK 73101  
Monte Maker, President  
Commodore Users of Norman  
209 Brookwood  
Noble, OK 73068  
Matt Hager

#### OREGON

NW PET Users Group  
John F. Jones  
2134 N.E. 45th Avenue  
Portland, OR 97213  
Pacific Northwest Commodore  
Users Group  
P.O. Box 2310  
Roseburg, OR 97470  
(503) 672-7591  
Richard Tsukiji

#### PENNSYLVANIA

PET User Group  
Gene Beals  
P.O. Box 371  
Montgomeryville, PA 18936  
Penn Conference Computer Club  
c/o Penn Conference of SDA  
720 Museum Road  
Reading, PA 19611  
Contact: Dan R. Knepp  
PACS Commodore Users Group  
LaSalle College  
20th & Olney Ave.  
Philadelphia, PA 19141  
(215) 951-1258  
Stephen Longo  
Glen Schwartz  
807 Avon  
Philadelphia, PA 19116  
Gene Planchak  
4820 Anne Lane  
Sharpsville, PA 15150  
(412) 962-9682  
PPG (Pittsburgh PET Group)  
c/o Joel A. Casar, DMD  
2015 Garrick Drive  
Pittsburgh, PA 15235  
(412) 371-2882  
Westmoreland Commodore  
Users Club  
c/o DJ & Son Electronics  
Colonial Plaza  
Latrobe, PA 15650  
Jim Mathers  
COMPSTARS  
440 Manatawny St.  
Pottstown, PA 19464  
Larry Shupinski, Jr.  
Meet at Audio Video  
Junction  
Commodore Users Club  
3021 Ben Venue Dr.  
Greensburg, PA 15601  
(412) 836-2224  
Jim Mathers  
VIC 20 Programmers, Inc.  
c/o Watson Woods  
115 Old Spring Rd.  
Coatesville, PA 19320  
Robert Gougher  
G.R.C. User Club  
300 Whitten Hollow Rd.  
New Kensington, PA 15068  
Bill Bolt  
NADC Commodore Users Club  
248 Oakdale Ave.  
Horsham, PA 19044  
Norman McCrary  
CACC (Capitol Area Commodore  
Club)  
134 College Hill Rd.  
Enola, PA 17025  
(717) 732-2123  
Lewis Buttery  
Union Deposit Mall at 7 p.m.  
G/C Computer Owners Group  
c/o Gilbert Associates, Inc.  
P.O. Box 1498  
Reading, PA 19607  
Extension 6472  
Jo Lambert (215) 775-2600  
Boeing Employees Personal  
Computer Club  
The Boeing Vertol Co.  
P.O. Box 16858  
Philadelphia, PA 19142  
(215) 522-2257  
Jim McLaughlin  
South Central PA Commodore Club  
2109 Cedar Run Dr.  
Camp Hill, PA 17011  
(717) 763-4219  
David Persing  
Main Line Commodore Users  
Group (MLCUG)  
c/o Main Line Computer Center  
1046 General Allen Lane  
West Chester, PA 19380  
(215) 388-1581  
Emil Volcheck  
Commodore Users Group  
781 Dick Ave.  
Warminster, PA 18974  
Matt Matulaitis  
The Commodore Users Club  
of S.E. Pittsburgh  
c/o Groves Appliance & TV  
2407 Pennsylvania Ave.  
West Mifflin, PA 15122  
Charles Groves  
**PUERTO RICO**  
CUG of Puerto Rico  
RFD #1, Box 13  
San Juan, PR 00914  
Ken Burch  
VIC 20 User Group  
655 Hernandez St.  
Miramar, PR 00907  
Robert Morales, Jr.  
**RHODE ISLAND**  
Irving B. Silverman, CPA  
160 Taunton Ave.  
E. Providence, RI 02914  
Contact: Michelle Chavanne

Newport VIC/64 Users  
10 Maitland Ct.  
Newport, RI 02840  
(401) 849-2684  
Dr. Matt McConeghy  
The VIC 20 Users Club  
Warwick, RI 02886  
Tom Davey  
Commodore Users Group  
c/o Data-Co.  
978 Tiogue Ave.  
Coventry, RI 02816  
(401) 828-7385  
Victor Moffett  
**SOUTH CAROLINA**  
Beaufort Technical College  
100 S. Ribaut Rd.  
Beaufort, SC 29902  
Dean of Instruction  
Computer Users Society  
of Greenville  
Horizon Records-Home Computers  
347 S. Pleasantburg Dr.  
Greenville, SC 29607  
(803) 235-7922  
Bo Jeanes  
Commodore Computer Club  
of Columbia  
318 Quincannon Dr.  
Columbia, SC 29210  
Buster White Sect./Treas.  
Spartanburg Commodore Users Group  
803 Lucerne Dr.  
Spartanburg, SC 29302  
(803) 582-5897  
James Pasley  
**SOUTH DAKOTA**  
PET User Group  
515 South Duff  
Mitchell, SD 57301  
(605) 996-8277  
Contact: Jim Dallas  
VIC/64 Users Club  
608 West 5th  
Pierre, SD 57501  
(605) 224-4863  
Larry Lundeen  
**TENNESSEE**  
River City Computer  
Hobbyists  
Memphis, TN  
1st Mon. at Main Library  
Nashville Commodore Users Group  
P.O. Box 121282  
Nashville, TN 37212  
(615) 331-5408  
Dave Rushing  
3rd Thurs. at Cumberland Mus  
Commodore User Club  
Metro Computer Center  
1800 Dayton Blvd.  
Chattanooga, TN 37405  
Mondays 7:30 pm  
Metro-Knoxville 64 Users Club  
7405 Oxmoor Rd., Rt. #20  
Knoxville, TN 37921  
(615) 938-3773  
Ed Pritchard  
Memphis Commodore Users Group  
2476 Ridvers Ave.  
Memphis, TN 38127



# user groups

(901) 358-5823  
Harry Ewart

## TEXAS

PET Users  
2001 Bryan Tower  
Suite 3800  
Dallas, TX 75201

Larry Williams  
P.O. Box 652  
San Antonio, TX 78293

PET User Group  
John Bowen  
Texas A & M  
Microcomputer Club  
Texas A & M, TX

CHUG (Commodore Houston  
Users Group)  
8738 Wildforest  
Houston, TX 77088  
(713) 999-3650  
Contact: John Walker

Corpus Christi Commodores  
3650 Topeka St.  
Corpus Christi, TX 78411  
(512) 852-7665  
Bob McKelvey

Commodore Users Group  
5326 Cameron Rd.  
Austin, TX 78723  
(512) 459-1220  
Dr. Jerry D. Frazee

VIC Users Group  
3817 64th Dr.  
Lubbock, TX 79413

Southeast Houston VIC  
Users Group  
11423 Kirk Valley Dr.  
Houston, TX 77089  
(713) 481-6653

64 Users Group  
2421 Midnight Circle  
Plano, TX 75075  
S.G. Grodin

Savid Computer Club  
312 West Alabama  
Suite 2  
Houston, TX 77006  
Davi Jordan, Chairman

Gulf Coast Commodore Users Group  
P.O. Box 128  
Corpus Christi, TX 78403  
(512) 887-4577  
Lawrence Hernandez

Mid-Cities Commodore Club  
413 Chisolm Trail  
Hurst, TX 76053  
Garry Wordelman

Mid-Cities Commodore Club  
413 Chisolm Trail  
Hurst, TX 76053  
Bruce Nelson

Interface Computer Club  
814 North Sabinas  
San Antonio, TX 78207  
M. E. Garza, President

Gulf Coast Commodore Users Group  
P.O. Box 128  
Corpus Christi, TX 78403  
(512) 887-4577  
Lawrence Hernandez

## UTAH

Utah PUG  
Jack Fleck  
2236 Washington Blvd.  
Ogden, UT 84401  
The Commodore Users  
Club  
742 Taylor Avenue  
Ogden, UT 84404  
Contact: Todd Woods Kap,  
President  
David J. Shreeve,  
Vice President

The VIClic  
799 Ponderosa Drive  
Sandy, UT 84070  
Contact: Steve Graham  
VIC 20 Users  
324 N. 300 W.  
Smithfield, UT 84335  
Dave DeCorso

Northern Utah VIC & 64  
Users Group  
P.O. Box 533  
Garland, UT 84312  
David Sanders

The Commodore Users Group  
652 West 700 North  
Clearfield, UT 84015  
(801) 776-3950  
Rodney Keller, Richard Brenchly

## VIRGINIA

Northern VA PET Users  
Bob Karpen  
2045 Eakins Court  
Reston, VA 22091  
(803) 860-9116

VIC Users Group  
Rt. 2, Box 180  
Lynchburg, VA 24501  
Contact: Dick Rossignol

VIC Users Group  
c/o Donnie L. Thompson  
1502 Harvard Rd.  
Richmond, VA 23226

Dale City Commodore  
User Group  
P.O. Box 2004  
Dale City, VA 22193  
(703) 680-2270  
James Hogler

Tidewater Commodore  
Users Group  
4917 Westgrove Rd.  
Virginia Beach, VA 23455  
Fred Monson

Fredericksburg Area  
Computer Enthusiasts  
P.O. Box 324  
Locust Grove, VA 22508  
(703) 972-7195  
Michael Parker

Commonwealth 20/64  
Users Group  
1773 Wainwright Dr.  
Reston, VA 22090  
(703) 471-6325  
Tal Carawan, Jr.  
VIC 20 Victims  
4301 Columbia Pike #410

Arlington, VA 22204  
(703) 920-0513  
Mike Spengel

Peninsula Commodore 64  
Users Group  
124 Burnham Place  
Newport News, VA 23606  
(804) 595-7315  
Richard G. Wilmoth

Norfolk Users Group  
1030 West 43rd St. B-4  
Norfolk, VA 23508  
489-8292  
Larry Pearson  
NASA VIC 20 User Group  
713 York Warwick Dr.  
Yorktown, VA 23692  
Harris Hamilton

135 Beverley Rd.  
Danville, VA 24541  
David Gray  
R.A.C.E. Commodore Users Group  
4726 Horseman Dr.  
Roanoke, VA 24019  
(703) 362-3960  
Larry Rackow

## WASHINGTON

NW PET Users Group  
2565 Dexter N. 3203  
Seattle, WA 98109  
Contact: Richard Ball

PET Users Group  
c/o Kenneth Tong  
1800 Taylor Ave. N102  
Seattle, WA 98102

Whidbey Island Commodore  
Computer Club  
947 N. Burroughs Ave.  
Oak Harbor, WA 98277

Michael D. Clark  
Central Washington  
Commodore Users Group  
1222 S. 1st St.  
Yakima, WA 98902  
Tim McElroy

Blue Mountain Commodore  
Users Club  
667 Canary Dr.  
Walla Walla, WA 99362  
(509) 525-5452  
Keith Rodue

Spokane Commodore User Group  
N. 4311 Whitehouse  
Spokane, WA 99205  
(509) 328-1464  
Stan White

## WEST VIRGINIA

Personal Computer Club  
P.O. Box 1301  
Charleston, WV 25325  
Cam Cravens

TriState Commodore Users  
73 Pine Hill Estates  
Kenova, WV 25530  
(304) 453-2124  
Marc Hutton

## WISCONSIN

Sewpus  
c/o Theodore J. Polozynski  
P.O. Box 21851  
Milwaukee, WI 53221

Waukesha Area Commodore  
User Group (WACUG)  
256½ W. Broadway  
Waukesha, WI 53186  
Contact: Walter Sadler  
(414) 547-9391

Commodore User Group  
1130 Elm Grove St.  
Elm Grove, WI 53122  
Tony Hunter

Commodore 64 Software  
Exchange Group  
P.O. Box 224  
Oregon, WI 53575  
E. J. Rosenberg

C.L.U.B. 84  
6156 Douglas Ave.  
Caledonia, WI 53108  
(414) 835-4645 pm  
Jack White  
2nd Sat every month 10:00 am  
VIC-20 & 64 User Group  
522 West Bergen Dr.  
Milwaukee, WI 53217  
(414) 476-8125  
Mr. Wachtl

Menomonee Area Commodore  
Users Group  
510 12th St.  
Menomonee, WI 54751  
(715) 235-4987  
Mike Williams

C. U. S. S. H.  
3614 Sovereign Dr.  
Racine, WI 53406  
(414) 554-0156  
Tim Tremmel  
3rd Saturday of month

Madison Area Commodore Users Group  
1552 Park St.  
Middleton, WI 53562  
(608) 831-4852  
John Carvin  
3rd Thurs. each month

S.W.I.T.C.H.  
W156 N8834 Pilgrim Rd.  
Menomonee Falls, WI 53051  
(414) 255-7044  
Len Lutz

Milwaukee Area CBM64  
Enthusiasts (M.A.C.E.)  
P.O. Box 340  
Elm Grove, WI 53122  
(414) 259-5991  
Kevin Wilde

The Eau Claire CBM64 Users Group  
Rt. 5, Box 179A  
Eau Claire, WI 54703  
(715) 874-5972  
John Slavsky, Jr.

## WYOMING

Commodore Users Club  
c/o Video Station  
670 North 3rd #B  
Laramie, WY 82070  
(307) 721-5908  
Pamela Nash

## CANADA

Toronto PET  
Users Group, Inc.  
1912A Avenue Rd., Ste. 1



# that does not compute...

Toronto, Ontario, Canada  
M5M 4A1  
(416) 782-8900  
or call 416-782-9252  
Contact: Chris Bennett  
PET Users Club  
c/o Mr. Brown  
Valley Heights Secondary School  
Box 159  
Langton, Ont. N0E 1G0  
Vancouver PET Users Group  
P.O. Box 91164  
West Vancouver, British  
Columbia  
Canada V7V 3N6  
CCCC (Canadian  
Commodore Computer Club)  
c/o Strictly Commodore  
47 Coachwood Place  
Calgary, Alberta, Canada  
T3H 1E1  
Contact: Roger Olanson  
W.P.U.G.  
9-300 Enniskillen Ave.  
Winnipeg, Manitoba R2V 0H9  
Larry Neufeld  
VIC-TIMS  
2-830 Helena St.  
Trail, British Columbia  
V1R 3X2  
(604) 368-9970  
Greg Goss  
Arva Hackers  
Medway High School  
Arva, Ontario N0M 1C0  
D. Lerch  
Nova Scotia Commodore  
Computer Users Group  
66 Landrace Cres.  
Dartmouth, N.S. B2W 2P9  
Andrew Cornwall  
Bonnyville VIC Cursors  
Box 2100  
Bonnyville, Alberta T0A 0L0  
(403) 826-3992  
Ed Wittchen  
Commodore Users Club of Sudbury  
938 Brookfield Ave.  
Sudbury, Ontario  
P3A 4K4  
PET Educators Group  
P.O. Box 454  
Station A  
Windsor, Ontario  
N9A 6L7  
COMVIC  
P.O. Box 1688  
St. Laurent  
Montreal, Quebec  
H4L 4Z2  
Calgary Commodore Users Group  
37 Castleridge Dr., N.E.  
Calgary, Alberta  
T3J 1P4  
John Hazard  
**FINLAND**  
VIC-Club in Helsinki  
c/o Matti Aarnio  
Linnustajankj 2B7  
SF-02940 ESP00 94  
Finland

## GERMANY

Kettenberg 24  
D 5880 Lueden Scheid  
West Germany  
Rudi Ferrari

## ITALY

Commodore 64 Club  
Universita di Studi shan  
V. Avigiana 13/1  
10138 TORINO  
ITALY

## KOREA

Commodore Users Club  
K.P.O. Box 1437  
Seoul, Korea  
Contact: S. K. Cha

## MEXICO

Asociacion De Usuarios  
Commodore  
c/o Alejandro Lopez  
Arechiga  
Holbein 174-6° Piso  
Mexico 18, D.F.  
Club de Usuarios Commodore  
Sigma del Norte  
Mol del Valle, Local 44  
Garza Garcia, N.L. 66220

## NEW ZEALAND

Commodore Users Group  
Meet at VHF Clubrooms  
Hazel Ave.

Mount Roskill  
3rd Wed. of month, 7:30 pm  
Roger Altena 278-5262  
Nelson VIC Users Group  
c/o P.O. Box 860  
Nelson, New Zealand  
Peter Archer  
E.R. Kennedy  
c/o New Zealand Synthetic  
Fuels Corp. Ltd.  
Private Bag  
New Plymouth

## NORWAY

VIC Club of Norway  
Nedre Bankegt 10,  
1750 Halden  
Norway

## UNITED KINGDOM

North London Hobby  
Computer Club  
Dept. of Electronics &  
Communications  
Engineering  
The Polytechnic of North  
London  
Holloway Rd.  
London N7 8DB  
Croydon Microcomputer Club  
111 Selhurst R.  
Selhurst, London SE25 6LH  
01-653-3207  
Vernon Gifford

## User Bulletin Board

### Telecommunications Bulletin Board For Commodore 64 Users:

(201) 521-2432  
All day Sunday, Monday, Tuesday;  
7 p.m.-10 a.m. Wednesday, Friday,  
Saturday; 9 p.m.-10 a.m. Thursday.

### VIC 20 or Commodore 64 Newsletter Exchange:

If your user group would like to ex-  
change newsletters, contact John  
Warren, Jr., 58 N. Ewing Street,  
Indianapolis, IN 46201.

### User Group for Kids Forming:

Contact Mike J. Sluchinski  
338 Costigan Crest  
Saskatoon, Saskatchewan  
Canada S7J 3P3  
373-0957

### Attention VIC 20/Commodore 64 Owners:

We'll type any program to tape for  
\$.00. Send listing or magazine  
pages for published programs, your  
tape and return postage to:  
Tom Keough  
Heartland User Group  
1220 Bartow Road #23  
Lakeland, FL 33801

## "Simons' BASIC"

Issue 26 (October/November)

In his article Jim Gracely  
said Simons' BASIC for the  
Commodore 64 is available on  
disk, which is not correct. It is  
available to users in the U.S.  
on cartridge.

## "Self-Modifying Programs"

Issue 26 (October/November)

The program listing needs one  
correction in line 70. That line  
should read: 70 GOTO 130.

## "Advanced Bit-Mapped Graphics on the Commodore 64, Part 2"

Issue 25 (August/September)

The program was written for  
use with a disk drive and was  
never checked using a datassette.  
Fortunately, the solution is simple.  
Just add this line to Listing #3  
(Demonstration Program):

15 POKE 833,0

This will fix the problem some  
readers were having with the  
Draw command.

This is not really a mistake in the  
program, but rather, location 833  
is assumed to be zero (which it is  
not if you load the program from  
datassette). The POKE 833,0  
should always be used after load-  
ing a graphics program from tape,  
but before running it. Therefore,  
the best place for it is right at the  
beginning of the program.



# that does not compute...

## “Getting the Most Out of (and Into) Your Disk Drive, Part 3”

Issue 25 (August/September)

The final mailing list program as it was published in Issue 25 doesn't do much as it stands—

unless you know how to tinker around with it. For those of you who don't know how to modify it, here is a completed version that works very well as a simple mailing list, for use with the 1541 disk drive.

```
10 REM ** DISPLAY MENU **
20 PRINT "[CLEAR]";:U=1
30 PRINT "[RVS,SPACE6]MENU[SPACE6,RVOFF]"
40 PRINT:PRINT:PRINT
50 PRINT "[RVS]1[RVOFF]...FORMAT[SPACE]DISKETTE"
60 PRINT
70 PRINT "[RVS]2[RVOFF]...NEW[SPACE]ITEM"
80 PRINT
90 PRINT "[RVS]3[RVOFF]...FIND[SPACE]ITEM"
100 PRINT:PRINT
110 PRINT "[RVS]4[RVOFF]...UPDATE[SPACE]ITEM"
120 PRINT:PRINT
130 PRINT"ENTER[SPACE]SELECTION[SPACE,SHFT R]"
140 GET A$:IF A$=""THEN 140
150 IF A$="1"THEN 200
160 IF A$="2"THEN 300
170 IF A$="3"THEN GOSUB 400
180 IF A$="4"THEN 500
190 GOTO 10
199 REM ** FORMAT A DISKETTE **
200 INPUT"DISKETTE[SPACE]NAME";D$
205 OPEN 15,8,15,"N:"+D$+",1A"
210 CLOSE 15
215 DATA A,B,C,D,E,F,G,H,I,J,K,L,M,N,O,P,Q,R,S,T,U,V,W,X,
    Y,Z
220 READ A$
225 OPEN 1,8,4,A$+",W"
230 PRINT#1,A$
235 CLOSE 1
240 IF A$="Z"THEN 20
245 GOTO 220
299 REM ** NEW ITEM **
300 REM ** NEW ITEM **
```



```

305 PRINT "[CLEAR]"
310 PRINT "[RVS,SPACE2]N[SPACE]E[SPACE]W[SPACE3]I[SPACE]T
[SPACE]E[SPACE]M[SPACE3,RVOFF]"
315 PRINT:PRINT
320 PRINT "[RVS]1[RVOFF]...LAST[SPACE]NAME"
325 PRINT
330 PRINT "[RVS]2[RVOFF]...FIRST[SPACE]NAME"
335 PRINT
340 PRINT "[RVS]3[RVOFF]...STREET[SPACE]ADDRESS"
345 PRINT
350 PRINT "[RVS]4[RVOFF]...CITY"
355 PRINT
360 PRINT "[RVS]5[RVOFF]...STATE"
365 PRINT
370 PRINT "[RVS]6[RVOFF]...ZIP[SPACE]CODE"
375 PRINT
380 PRINT "[RVS]7[RVOFF]...SAVE"
385 PRINT
390 PRINT "[RVS]8[RVOFF]...EXIT"
392 PRINT:PRINT"ENTER[SPACE]SELECTION[SHFT R]":GOSUB 600
395 GOTO 305
399 REM ** FIND A FILE **
400 INPUT"FILE[SPACE]TO[SPACE]FIND";FI$
405 FR$=LEFT$(FI$,1)
410 OPEN 1,8,4,FR$+",R"
415 INPUT#1,G$
420 INPUT#1,G$,T,S
425 IF G$=FI$THEN 440
430 IF ST=0 THEN 420
435 PRINT ST:CLOSE 1:PRINT"FILE[SPACE]NOT[SPACE]FOUND"
:FOR Z=1 TO 500:NEXT:S=1:RETURN
440 CLOSE 1
445 OPEN 15,8,15
450 OPEN 2,8,2,"#"
455 PRINT#15,"B-R:"2;0;T;S
460 FOR R=1 TO 6
465 INPUT#2,I$(R)
470 PRINT I$(R)
475 NEXT
477 PRINT "[DOWN2,RVS]PRESS[SPACE]SPACE[SPACE]BAR[SPACE]TO
[SPACE]CONTINUE[RVOFF]"
478 GET A$:IF A$<>"[SPACE]"THEN 478
480 CLOSE 2:CLOSE 15:RETURN

```



# that does not compute...

```
500 GOSUB 400:IF S=1 THEN S=0:GOTO 10
502 REM ** UPDATE ITEM **
505 PRINT"[CLEAR]"
510 PRINT"[RVS,SPACE2]U[SPACE]P[SPACE]D[SPACE]A[SPACE]T
      [SPACE]E[SPACE3]F[SPACE]I[SPACE]L[SPACE]E[SPACE3,
      RVOFF]"
515 PRINT:PRINT
520 PRINT"[RVS]1[RVOFF]...LAST[SPACE]NAME"
525 PRINT
530 PRINT"[RVS]2[RVOFF]...FIRST[SPACE]NAME"
535 PRINT
540 PRINT"[RVS]3[RVOFF]...STREET[SPACE]ADDRESS"
545 PRINT
550 PRINT"[RVS]4[RVOFF]...CITY"
555 PRINT
560 PRINT"[RVS]5[RVOFF]...STATE"
565 PRINT
570 PRINT"[RVS]6[RVOFF]...ZIP[SPACE]CODE"
575 PRINT
580 PRINT"[RVS]7[RVOFF]...SAVE"
585 PRINT
590 PRINT"[RVS]8[RVOFF]...EXIT"
592 PRINT:PRINT"ENTER[SPACE]SELECTION[SHFT R]":GOSUB 600
595 GOTO 505
597 GOSUB 800
599 GOTO 20
600 REM ** INPUT ROUTINE **
610 GET A$:IF A$=""THEN 610
620 IF VAL(A$)=0 THEN 600
630 A=VAL(A$)
640 IF A=7 THEN 700
650 IF A=8 THEN 20
660 PRINT"ITEM";A;
670 INPUT I$(A)
680 RETURN
700 REM ** SAVE ROUTINE **
710 OPEN 15,8,15,"IO":OPEN 2,8,4,"#"
715 IF U=1 THEN U=0:GOTO 760
720 PRINT#15,"B-A:"0;1;1
730 INPUT#15,A,B$,T,S
740 IF B$="OK"THEN T=1:S=1:GOTO 760
750 PRINT#15,"B-A:"0;T;S
760 FOR X=1 TO 6:PRINT#2,I$(X):NEXT
```



```

761 PRINT#15,"B-W:"4;0;T;S
770 CLOSE 2:CLOSE 15
780 F$=LEFT$(I$(1),1)
790 OPEN 1,8,4,F$+",R"
799 REM** SWAP THE CONTENTS **
800 OPEN 2,8,2,"TEMP,W"
810 INPUT#1,L$
815 SB=ST
820 PRINT#2,L$
825 IF SB<>0 THEN GOTO 840
830 GOTO 810
840 CLOSE 1
850 PRINT#2,I$(1)
860 PRINT#2,T
870 PRINT#2,S
880 CLOSE 2
890 OPEN 15,8,15,"S0:"+F$
900 PRINT#15,"R0:"+F$+"=TEMP"
910 CLOSE 15:RETURN

```

## “Where Are We”

Issue 24 (June/July)

Our designers chopped some crucial spaces out of Liz Deal's machine language program listing here. The listing should look like this:

```

1 REM"S=SAVE"1:WHERE",08
500 REM-----
510 REM WHERE ARE WE ELIZABETH DEAL
520 REM-----
530 A1=58:A2=62
540 DEFFNPP(Q)=PEEK(Q)+256*PEEK(Q+1)
550 DEFFNHI(Q)=INT(Q/256)
560 DEFFNLO(Q)=Q-256*FNHI(Q)
570 DATA NOT HERE
580 Y=FNPP(FNPP(A1)+1)-1:POKEA2,FNLO(Y):POKEA2+1,FNHI(Y)
590 REM READ POINTER HAS NOW BEEN SET TO THIS LINE
600 READQ$:PRINTQ$
610 DATA HERE
620 POKEY+6,94-PEEK(Y+6):REM NOW LIST
630 REM-----

```



# that does not compute...

# new products

```
640 :
650 DISASSEMBLY - $C2D7 CONTAINS RTS
660 ($60) IN UPGRADE PET
670 :
1100 ., 4080 20 D7 C2 JSR $C2D7
1101 ., 4083 BA TSX
1102 ., 4084 BD FF 00 LDA $00FF,X
1103 ., 4087 A8 TAY
1104 ., 4088 BD 00 01 LDA $0100,X
1105 ., 408B 00 BRK
1106 .R
1107 : PC IRQ SR AC XR YR SP
1108 .; 4080 9053 30 00 5E 04 F8
1109 .G
1110 B*
1111 : PC IRQ SR AC XR YR SP
1112 .; 408C 9053 30 40 F8 82 F8
1113 .X -- --
1114 READY.
1115 REM-----
```

## “Subject-Oriented Educational Software for Commodore Computers”

Issue 23 (April/May)

Throughout “Who Supplies What for Whom” on pages 63-64 we listed Courseware Magazine as a resource. That information is out of date. The company is now called School & Home Courseware, Inc. and is located at 1341 Bulldog Lane, Suite C, Fresno, California 93710. Phone 209-227-4341.

C

*The following information is taken from new product announcements sent to us by independent manufacturers and is provided only to help keep our readers abreast of developments. Commodore does not endorse any of the products mentioned, has not tested them and cannot vouch for their availability. If you have any problems with any of the products listed here, please write to us.*

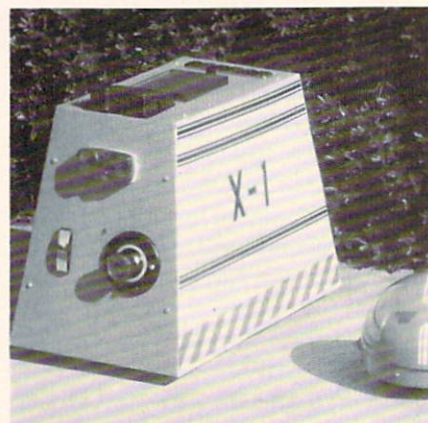

### Company:

Robot Shack  
P.O. Box 582  
El Toro, CA 92630  
714-768-5798

### Product:

Emotional Home Robots—Add “emotions” to the Robot Shack X-1 Robot kit or any robot built from scratch using Robot Shack parts. The “emotion” option con-



sists of a low-cost computer that mounts in the robot coupled to electronic devices that allow the robot to wobble with emotion, shriek with joy, turn red, shiver, etc., depending on circumstances. Includes software.  
Price: Complete kits \$99.95 and up. Information package available for \$5.00 refundable with first order.

**Company:**

Swearingen Software  
6312 W. Little York, Suite 197  
Houston, TX 77088  
713-937-6410

**Product:**

*Pick That Tune*—Game for the Commodore 64. Contains 100 different popular tunes divided into four categories. One to ten players bid on the number of notes they think they will need to identify a tune. Additional tune categories, each containing 100 songs, available separately.  
Price: Base program with documentation \$29.95 disk. Additional tunes \$9.95 disk.

**Company:**

Powerline Software  
P.O. Box 635  
New Hartford, NY 13413

**Product:**

*Casino Roulette*—Game for the Commodore 64 or VIC 20 with 8K expander. Creates a roulette board display and places chips when bets are made. Allows for either European or American style play and for changing casino payoffs. Accepts up to five players at

once. On tape for the VIC; on tape or disk for the 64.

Price: \$19.95 any version.

**Company:**

Quality Data Services  
2847 Waiialae Avenue,  
Suite 104  
Honolulu, HI 96826  
808-735-1202

**Product:**

COM-MASTER—Assembly language communications monitor for the SuperPET. Allows the SuperPET to emulate a Lear-Siegler ADM-3A at baud rates as high as 19,200. Also includes the ability to transmit and receive data files between a Commodore disk and a wide variety of remote systems. Fully buffered and interrupt-driven input and output through serial port, ASCII control codes via use of the OFF/RVS key as a CONTROL key, true serial BREAK key using the STOP key and more.  
Price: \$95.00

**Company:**

Spinnaker Software  
215 First Street  
Cambridge, MA 02142  
617-868-4700

**Product:**

*Cosmic Life*—Game on cartridge for the Commodore 64, in the tradition of "Go!" and checkers. Available by Christmas.  
Price: Contact company.

**Company:**

Sirius Software, Inc.  
10364 Rockingham Drive

Sacramento, CA 95827  
916-366-1195

**Product:**

Games for the Commodore 64—*Gruds in Space* is an adventure game with over 150 animated screens and a humorous story line. Another graphic adventure, *Blade of Blackpoole*, is also available. *Squish 'Em* is available on cassette for the VIC 20 with 8K expander as well as the 64. *Capture the Flag* was shown for the first time at Summer CES, and should be available soon.  
Price: 64 versions \$39.95 each. *Squish 'Em* for VIC \$19.95.

**Company:**

Infinity Software  
536 Curie Drive  
San Jose, CA 95123  
408-629-6208

**Product:**

Two adventure programs for the Commodore 64—*Bandits at 4 O'Clock*, on tape or disk, simulates the action of a B-36 tail gunner in high-res graphics. Requires joystick. *Stardate 6000*, which employs inter-active logic features, is a futuristic adventure on disk or tape. Uses keyboard.  
Price: \$29.00 each

**Company:**

Creative Software  
230 East Caribbean Drive  
Sunnyvale, CA 94089  
408-745-1655

**Product:**

*In the Chips*—Educational cartridge game for the VIC 20. Tests



# new products

the entrepreneurial abilities of one or two players, who develop and operate rival software companies. The object is to use your capital in the most efficient way in order to "out-profit" your competition. When players finish, they see their financial results for the quarter, and must use that information to make future inventory, pricing and budgeting decisions.  
Price: \$29.95

## Company:

RAK Electronics  
P.O. Box 1585  
Orange Park, FL 32067-1585  
904-264-6777

## Product:

Formulas II—Software for ham radio operators with Commodore 64 or VIC 20 and 8K expander. Includes formulas for decimal/hex/binary conversion, decibel gain/loss, resistor color codes, coaxial cable loss, coil winding calculator and more.  
Price: \$6.95 plus \$2.00 shipping.

## Company:

Celestial Software  
3010 Warrington Avenue  
Lakeland, FL 33803  
813-686-3311

## Product:

*Astronomy Pac*—On cassette for Commodore 64 or VIC 20 with 8K expander. Generates its own almanac data and contains information on Aries and 57 of the most prominent stars, which enables the user to print the location of these stars for anytime from 1983 to 2000 from any location

on earth. Tell the computer the time, date and your approximate position. Input the height and azimuth of the star. The computer then determines which star you observed. Package includes software, instructions, astrolabe, compass and book titled *The Stars* by H.A. Rey.  
Price: \$59.95

## Company:

Computer Associates, Inc.  
1304 13th Avenue S.  
Fargo, ND 58103  
701-280-1837

## Product:

Video\*Clear Interference Rejection Cable—Designed to eliminate or reduce video interference in microcomputers. Replaces the existing video cable between the computer and the T.V. set or monitor. Completely external.  
Price: \$14.95

## Company:

bitCards  
120 South University Drive,  
Suite F  
Plantation, FL 33317  
305-473-4741

## Product:

bitCards—For the Commodore 64 or VIC 20. Text-and-graphics adventures intended to be given as gifts. Each bitCard is custom-programmed with personalized references to the recipient. The first, *A Christmas Adventure*, also contains a personal holiday greeting in the sender's own words.  
Price: \$18.50 all versions. C

# advertisers' index

Advertisers	Page No.
Academy Software	21
Arbutus Total Software	30
Bytes and Bits	101
Cardinal Software	28
Cheat Sheet Products	113
Commodore	6 & 7, 8 & 9 10 & 11, 12 & 13, 77, IFC, IBC,
Connecticut Microcomputer	16
Cowboy Computing	26
ETC	33
Financial Services	
Leading Edge	OBC
Marketing Corporation	80
Geneva Technology	66
Input Systems	28
Micro 80	61
Microsignal	101
New Leaf	84
Northland Accounting, Inc.	113
Peek Software	61
Precision Technology	66
Public Domain	63
Quality Data Systems	63
R & D Software Unlimited	30
Sota Enterprises	5
Southern Case, Inc.	23
Star Micronics	1
Suckle	93
The Software Buyer's Report	79



# IF PERSONAL COMPUTERS ARE FOR EVERYBODY, HOW COME THEY'RE PRICED FOR NOBODY?

A personal computer is supposed to be a computer for persons. Not just wealthy persons. Or whiz-kid persons. Or privileged persons.

But person persons.

In other words, all the persons whom Apple, IBM, and Radio Shack seem to have forgotten about (including, most likely, you).

But that's okay. Because now you can get a high-powered home computer without taking out a second mortgage on your home.

It's the Commodore 64. We're not talking about a low-priced computer that can barely retain a phone number. We're talking about a memory of 64K. Which means it can perform tasks most

**\$1395\***  
APPLE® IIe 64K

**\$999\***  
TRS-80® III 16K

**\$1355\***  
IBM® PC 64K

other home computers can't. Including some of those that cost a lot more. (Take another look at the three computers above.)

By itself, the Commodore 64 is all the computer you'll ever need. Yet, if you do want to expand its capabilities some day, you can do so by adding a full complement of Commodore peripherals. Such as disk drives. Modems. And printers.

You can also play terrific games on the Commodore 64. Many of which

will be far more challenging than those you could ever play on a game machine alone.

And as great as all this sounds, what's even greater-sounding

is the price. It's hundreds of dollars less than that of our nearest competitor.

So while other companies are trying to take advantage of the computer revolution, it seems to us they're really taking advantage of something else:

Their customers.

\*Manufacturers' suggested list prices. Monitor included with TRS-80 III only. Commodore Business Machines—PO Box 500R, Conshohocken, PA 19428; Canada—3370 Pharmacy Avenue, Agincourt, Ont., Can. M1W 2K4

**commodore**  
COMPUTERS

Apple is a registered trademark of Apple Computer, Inc. TRS-80 is a registered trademark of Tandy Corp. IBM is a registered trademark of International Business Machines Corp.

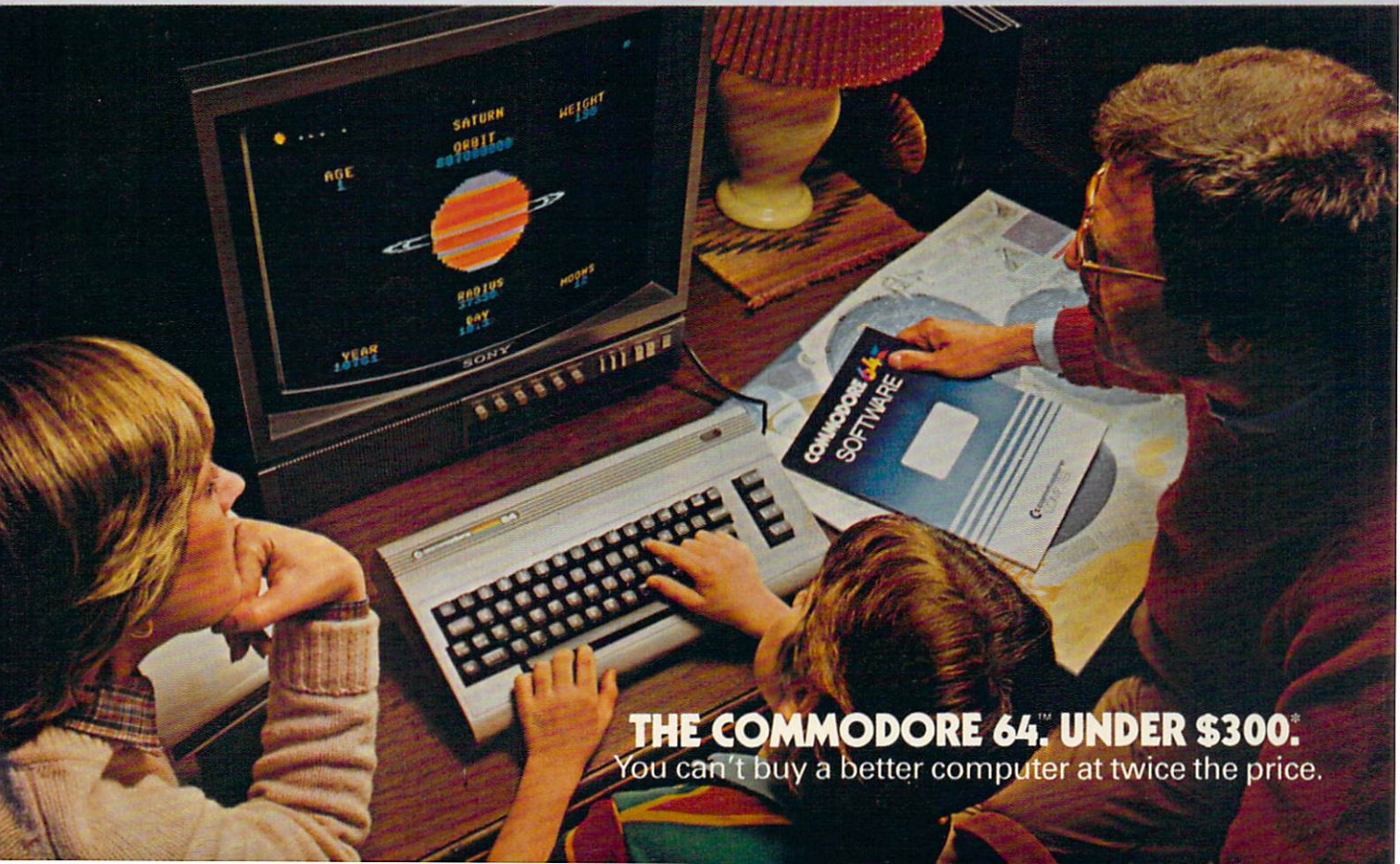

**THE COMMODORE 64™. UNDER \$300.\***  
You can't buy a better computer at twice the price.



## THE SECRETS OF PERFECT MEMORY: ONE AND ONE HALF EARTH DOLLARS

AT LAST: THE WHOLE  
TRUTH ABOUT FLOPPIES.

Amazing book reveals  
all!

How to keep from  
brainwashing your disk  
so it never loses its  
memory.

How fingerprints can  
actually damage disks.  
Unretouched Kirlian  
photographs of UFO's  
(Unidentified Floppy  
Objects)! The incredible  
importance of making  
copies: the Department  
of Redundancy Depart-  
ment—and what goes on  
when it goes on! Power-  
ful secret methods that  
scientists claim can ac-  
tually prevent computer  
amnesia! All this, and  
much more . . .

In short, it's an 80-  
page plain-English,  
graphically stunning,  
pocket-sized definitive  
guide to the care and  
feeding of flexible disks.

For The Book, ask your  
nearest computer store  
that sells Elephant™  
disks, and bring along  
one and one half earth  
dollars.

For the name of the  
store, ask us.

**ELEPHANT MEMORY  
SYSTEMS®** Marketed  
exclusively by Leading  
Edge Products, Inc.,  
Information Systems  
and Supplies Division,  
55 Providence Highway,  
Norwood, MA 02062. Call  
toll free 1-800-343-8413.  
In Massachusetts, call  
collect (617) 769-8150,  
Telex 951-624.

