

Vol 5 No 9

September \$3.50*

The Australian **COMMODORE** and **AMIGA REVIEW**

HOXTON PARK
N.S.W.
NOV 1988
NEWSAGENCY 607 4179
\$3.50

What's happening
with Amiga animation?



- World of Commodore show guide
- GEOS/128 column
- Windows program for your C64
- Latest Amiga news
- Desktop publishing update
- Review - F/A 18-Interceptor

Registered by Australia Post Publication No NGB 6656

* Recommended Retail Price

⚡ Pactronics the new Power in Entertainment software ⚡

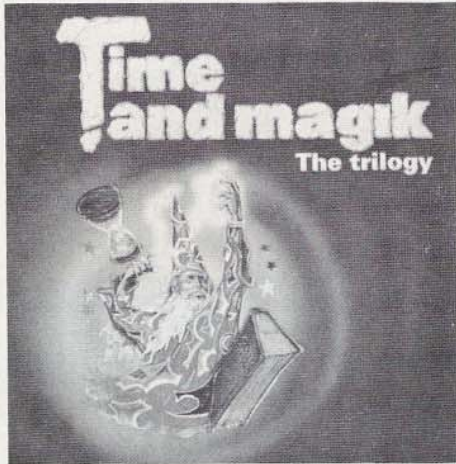

TIME AND MAGIK is a complete trilogy of "Level 9" graphic adventures.

**LORDS OF TIME
RED MOON
THE PRICE OF MAGIK**

Each has been enhanced and enlarged with more text than ever before - 60,000 words, creating Magik and Mystery around every corner. There is a powerful new parser, and all disk versions feature stunning full colour graphics.

You don't have to be into cricket to enjoy Graham Gooch's **ALL STAR TEST CRICKET**. Just plug in your Joysticks and go for it - arcade style. For the serious cricket fan - there's the simulation mode with the accent on strategy and tactics.



- Superb life like animation
- Arcade or simulation mode
- One or two player options
- Full Test Match or Limited Over Match
- Practise mode for both batting and bowling
- Nine built-in Test Sides
- Create your own teams
- High quality sound effects
- Digitised speech
- Action replay of dismissals
- Authentic score cards and bowling figures.

Classic Quest - **Goblin Towers**

Somewhere in the centre of a huge forest lies an old castle. Legends and rumours about it abound, for it has been standing for many hundreds of years, and there are said to be great riches hidden in the depths of the castle. Though many adventurers have gone in search of this wealth, some have disappeared without trace, and the rest have failed to discover the exact whereabouts of the castle. Perhaps there is some truth in the legend of a hideous beast which guards the treasures of the castle.

Other titles include: **FORESTLAND, WITCH HUNT, CATACOMBS.**



Available from Maxwells Office Equipment, Microcomputer Spot, Grace Bros, Chandlers, and from leading computer retailers around Australia.

FOR THE NEAREST RETAILER IN YOUR STATE CONTACT:

N.S.W. : Pactronics Pty Ltd, 33-35 Alleyne Street, Chatswood. (02) 407 0261

VICTORIA : Pactronics Pty Ltd, 51-55 Johnston Street, Fitzroy. (03) 417 1022

QUEENSLAND : Pactronics Pty Ltd, 12 Stratton St, Newstead, 4006. (07) 854 1982

SOUTH AUSTRALIA: Baringa Pty Ltd, (08) 271 1066 ext. 6132

WESTERN AUSTRALIA: Pactronics W.A. 1/757 Canning Highway, Ardross (09) 364 8711

NEW ZEALAND: Micro Dealer, 60 Terakau Drive, Palupanga, Auckland. (09) 274 9300

Mail Order - "Software To Go" - (02) 457 8289



Arcade Classics



Super Pac-Man™

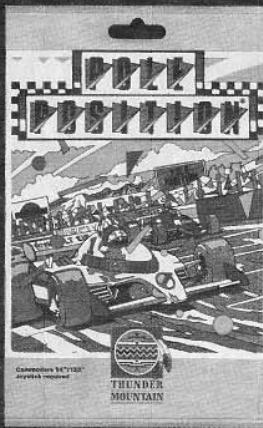

Pole Position™



Jr. Pac-Man™



Galaxian™



MS. Pac-Man™



Pac-Man™



Dig Dug™

A BLAST
FROM THE PAST!

Available on the
following
formats:
IBM, Apple
CBM 64

EXPERIENCE THE THUNDER

5-6 Gladstone Rd, Castle Hill, NSW 2154 (02) 899 2277 FAX (02) 899 2348

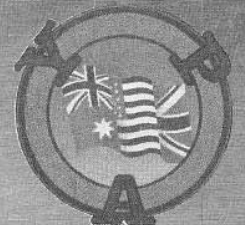

THUNDER
MOUNTAIN

The Australian COMMODORE and Amiga Review

VOL. 5 NO. 9

September 1988

CONTENTS		PAGE
Editorial		3
Ram Rumbles	The latest news	4
Letters	Fastloaders, GEOS printer drivers, Modems etc.	6
World of Commodore	What's happening at the Commodore Exhibition	9
Suite 64 - Disk Magazine 11	Impressive improvements to our disk magazine	14
Graphics Label Wizard	A label maker for the C64	15
Modernising your 64	Was your C64 made before January 1984?	18
Arcade Action	LA Crackdown, Skate Crazy, Arac, Nebulus, Bionic Commando, Karnov, Shoot-em-up Con. Kit	20

AMIGA REVIEW between pages 20 and 21

128 Corner - GEOS	Word processing and Ram expander	26
Superbase	Recovering from errors	28
BBSing in WA	Isolated by distance, desert and sea.	30
C128 Pokes & Sys Calls	Loads of Pokes and Sys Calls	32
Quick Disk Searcher	Find the location of a string of hexadecimal no's	34
Disk Doctor 64	Rescue your disks from corruption	36
Pages Basic Loader	Windows within your Basic program - update	36
Adventurer's Realm	News, reviews and help for adventurers	38

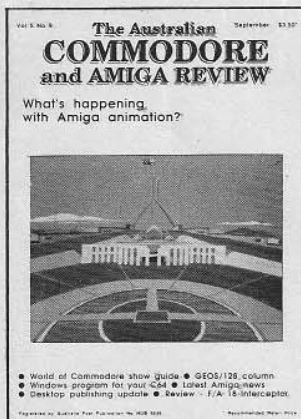

Australian Commodore Review

21 Darley Road, Randwick, NSW 2031.

Phone: (02) 398 5111

Published by: Saturday Magazine Pty Ltd.

Editor: Andrew Farrell

Assistant Editor: Adam Rigby

Advertising: Ken Longshaw
(02) 398 5111 or (02) 817 2509

Production: Brenda Powell

Layout: Amanda Selden

Subscriptions & back issues:

Tristan Mason (02) 398 5111

Distribution: NETWORK

Printed by: Ian Liddell Pty Ltd

Editorial

Watch for the October Edition

OUR AMIGA SECTION is bursting at the seams. We just can't fit enough editorial into the pages available. So, it's time for a change. Starting from our October issue, the *Australian Amiga and Commodore Review* will begin a new life. No longer will the Amiga section be a separate entity.



Instead, the entire magazine will be a mixture between C64/128 and Amiga articles. Our current 50/50 editorial split will continue. However, there are some big advantages. Since we no longer have a redundant second cover, there's more room for editorial. Plus many programs are released on both the Amiga and C64 - now one review will cover all.

Programs such as superbase are now available on both machines - thus columns covering these products could easily contain a mixture of information for both models, along with a few specific items.

We certainly don't want you to think we're forgetting about the C64. In fact, we can probably look after you even better. All the regular sections will stay. A few new ones will be appearing covering BASIC programming from start to finish.

Amiga owners can look forward to tutorials on C and BASIC in coming months, as well as all the usual news, hints and tips, letters from readers, and honest product reviews. Amiga is really happening in a big way down under, and we plan to be there in the thick of it. ■

Andrew Farrell

FOR SALE

Amiga 1000 for sale, 1081 monitor plus external disk drive. Heaps of software plus subscription to *Australian Commodore and Amiga Review*. **\$1800**
Phone Adam (02) 981 1074

The Australian COMMODORE and AMIGA Review

*Make sure of getting
your copy
Subscribe now!*

Please enrol me for issues
subscription to
The Australian Commodore and Amiga
Review, commencing with the
issue.

I enclose a cheque/money order for \$. .

Please charge my

Bankcard number.....

Expiry date.....

Name:.....

Address:.....

.....Postcode.....

Please tick applicable box

First Subscription

Renewal

**TO: The Australian
Commodore
and Amiga Review
21 Darley Road,
Randwick NSW 2031
(02) 398 5111**

Rates within Australia:

6 issues \$18.00 (including postage)

12 issues \$34.00 (including postage)

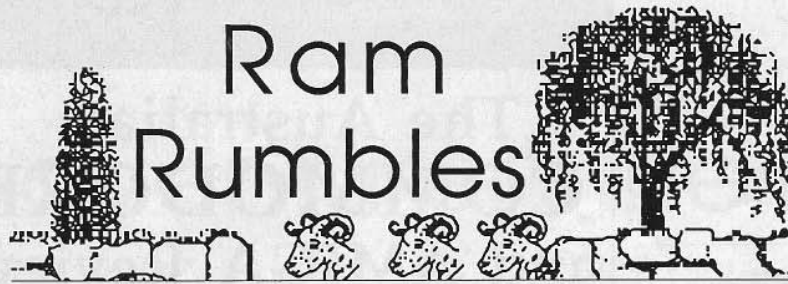

Save the President

In *The President is Missing*, an economic summit in the heart of Austria is turned into a nightmare for the President of the United States and ten European heads.

Deadly serious terrorists have abducted them. The terrorists know what a prize they have and how to use it!

You have been selected as the agent to co-ordinate their recovery before the world slips into chaos.

At your command you have eight agents which you can deploy to anyone of the 48 suspects or twelve locations to interrogate and investigate.

Time is absolutely critical, no time can be wasted chasing false leads.

A top adventure which scored 9 out of 10 in *Commodore User*, 100% in *24 Carrot Gold* and *P.C.W.* said "This game will cause many sleepless nights.

Features interactive audio cassette, which is played simultaneously. (providing useful hints and tips).

Formats: C64 and IBM initially, Amiga and Atari ST quickly after.

For further information: Questor, (02) 662 7944.

Errata

● **Geos 128** works well with Ram expansion. It requires 165K if properly configured, however, so the Commodore 1700 unit mentioned in some copies of the manual won't work as that unit only has 128K. The 1750 unit with 512K is the one to use and Commodore Australia has it.

● **Fleet Systems 4**, the 128 word processor, has a couple of errors in its manual. Page 1-7 points to a list of compatible printers in Appendix G. This is actually in Appendix C. Page 1/2 says that it works with the 1541 drive. In fact

on PAL systems this drive won't work, although there are no problems with the 1571 drive.

New paint program

Just when we thought that no more paint programs were going to come out for the C64.

Masterpiece is a new multicolour paint package for the C64 that allows special effects like scaling, rotation, twisting, and folding of onscreen art, from Scorpion, 19 Harbor Dr., Lake hopatcong NJ 07849, 201-663-0202.

Sounds like it may compete with the likes of *OCP Art Studio*.

Kids' pics

Along a similar vein, *Color Me* from Mindscape is a package to let children make their own colouring books. It has a kid-level drawing program and comes with two disks of clip art, one of which features Rainbow Brite characters. The box comes with paper, buttons, crayons, and other keen stuff. Mindscape also offers additional clip art disks (US\$9.95 each) and supply refills. List price is US\$34.95. 3444 Dundee Rd., Northbrook, IL 60062. 312-480-7667.

Ultima V

The continuation of the long series of *Ultima* games is expected here in Australia soon. It boasts more monsters, magic and mania. This should satisfy all your adventuring needs.

Warp speed

In the theme of the recent explosion of cartridges for the Commodore 64 Cimemaware has released their entry into the market - Warp Speed!

Update

I have to start this month's column with an apology. As most of you know Pactronics tends to market software only where it can get exclusivity to distribute in Australia. This helps to ensure that we can maintain our prices to you and give you good back-up service and the confidence that when you buy a product and there is a problem then our hot line is always available. Well, after having written last month's column I discovered that another importer was bringing in *Arkenoids* and *Zoom* despite having been promised this would not be so. We have therefore cancelled our orders.

The good news, however, is that I have signed up with another company who will shortly be sending us great new games for both the Commodore and Amiga, and I have also found some wonderful new educational products which can sell for as little as \$19.95 on Commodore. We also have coming programs such as trigonometry, algebra, biology, etc of very high quality and standard for the C64 and PC Compatibles.

For those of you who are still patiently waiting, the good news is that the new stock of FINAL CARTRIDGE II and Abacus books have landed - the bad news is that the customs officers strike is still on and we just have to wait our turn for clearance.

You will see further on in this magazine an impartial write-up on our Disk Drive and I am afraid, rather immodestly, I consider it to be the best Commodore Compatible Disk Drive available in Australia today. As you know all Commodore Disk Drives are being advertised as being 100% compatible, but what this really means is that they are compatible with the computer but not necessarily with the software. Based on extensive and time consuming experimentation, we believe that our Drive is compatible with 99.5% of the software, as well as being totally compatible with the C64.

For you Amiga buffs, make sure you look at the advertisements on pages 11 and 18 of the Amiga section. Remember, it Pays to Purchase Pactronics software and Peripherals.

And this goodbye is for the oldies amongst us.

SYLA

Advertisement

Australian Commodore Review

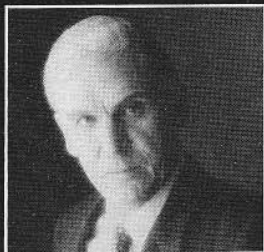

**"COMMODORE COMPUTERS
ARE SO FAR AHEAD OF
ANYTHING ELSE AT THE SHOW,
THEY'RE IN A WORLD
OF THEIR OWN."**

John Gaud

Don't expect to see a Commodore computer
at the Australian Computer Exhibition.

Commodore computers are so far ahead of the rest, they are literally in a world
apart. A totally separate exhibition in conjunction with the Australian Computer Exhibition.

It's called World of Commodore, and admission is free.

WORLD OF COMMODORE

At World of Commodore, you can see the very latest software for the world's most advanced graphics computer, the revolutionary
Commodore Amiga. Including the amazing new colour palette and 3-D graphics software.

You'll also have the chance to saddle up the brand new Commodore PC Colt, Commodore's newest MS-DOS PC.

Like all Commodores, it's dedicated to giving you more features for less money.

And if you're a Commodore C64 owner, you'll see all the latest games, software and peripherals on display and working.

In fact, many of Australia's leading software companies will be at World of Commodore, demonstrating their latest
developments on Commodore computers.

Admission to World of Commodore is free, and the entrance is just next door to the Australian Computer Exhibition.

You could even be the lucky person who wins the "World of Commodore" competition.

So come on in, and find out why the others just can't keep up with Commodore.

 **commodore**

**WORLD OF COMMODORE
ADJOINING THE AUSTRALIAN
COMPUTER EXHIBITION,
DARLING HARBOUR
EXHIBITION CENTRE,
SEPT. 20-22.**

**ADMISSION
FREE!**



ARE YOU KEEPING UP WITH COMMODORE

© 1987 Commodore Australia Pty. Ltd. All rights reserved.

LETTERS

TO THE EDITOR

Fastloaders

I very much enjoy your *Superbase* and *Geos* articles. I would like to see some discussion of the use of duplicate key fields, particularly the methods of selecting all the occurrences not just the first.

Also I would like to know if there are any cartridges which will fastload/save SEQ and /or REL type files. All those which you have reviewed so far either do not have this ability, or do not say anything in the review about these file types.

Two comments on the magazine. First, why don't you use a spelling checker program? Second, too much of the magazine is taken up with games, to the detriment of education and programming.

**John Badger
Eden Hills**

Ed - We do sometimes . . . Try Dolphin DOS or Mach IV.

Paperclip III and MSP 1000

Following your review of *PaperClip III* in the May issue of your magazine, I decided to write to you to see if you can help me.

Up till now I have been quite happily using the original *PaperClip* program, but because of the dual mode setup (IBM/Commodore) of my printer, the MPS 1000, I have not been able to access any pitches other than those available in Commodore mode: elite, NLQ and enlarged. When I originally bought this program, I spent weeks trying to set up a printer file which would access the IBM mode, only to be told later by the company marketing *PaperClip* (ECP) that this was not possible with the current pro-

gram. In every other way, I have been perfectly happy with this program.

However, when I saw that *PaperClip III* was claiming access to eight different printer pitches and listed the MPS 1000 as one of the printers compatible with it, I decided that it was worth spending \$100 to finally be able to use all the pitches my printer was capable of producing.

My problem is that I can't even get the printer file for the MPS 1000 working, let alone access the different pitches. I have spoken to the programmer at ECP in Queensland twice over the phone at my own cost - the Sydney office refused to ring through with my problem!

When the programmer couldn't solve my problem his reaction was: "Well, if you can't do it it's no problem because you can get your money back." He was quite willing to end the discussion on this note, except that I insisted that I wanted the program and asked him to contact the American company with my problem, seeing he couldn't help me. I am still waiting to hear from him.

In desperation I am writing to you as I do not seem to be getting anywhere with the so-called Customer Support services. I have tried changing the Dip switches to the recommended setting for IBM mode (1-1, 1-3 and 1-8 on) but get no printout at all. If I leave all switches off, the printer feeds through one sheet of paper and then prints rubbish. By the way, I am using a Commodore 64. (No interfaces, serial connection).

Any help or suggestions that you could give me would be greatly

appreciated.

**Ann Hodgson
Lakemba**

Ed - Australia really is a long way from realising the true meaning of customer service. One well treated problem can equal dozens of recommendations. Sorry, but we don't have the combination of gear your problems are on to try - however, maybe a reader can help? Contact the magazine by phone if you can.

GEOS printer drivers

I am writing for HELP!

In the June issue of AC & AR (Vol 5 No 6) G. Woodwell's letter mentioned he was using the *Geos* program to type his letter. I also have a Commodore Propack (Commodore 64C and 1541 drive) and a Citizen 120D printer as well. The problem is: HOW does one get a printout from *Geos*???

Please can someone provide some light on this matter as using this manual typewriter and staying sane is just about impossible! Can *geoPaint* be printed as well, I wonder?

**Jennifer Widders
Redfern**

Ed - Our Disk Magazine No 11 has what you're after, as well as a printer driver for: Blue Chip M120, C Itoh 85010 & 10A, Epson FX80, JX80, MX80, Gemini 10X, 4P-Laserjet, IBM 5152 Plus, Imagewriter & Imagewriter II, MPS 801, 1000, OKI 120 NQL, Olivetti PR2300, OKIML92193, Okimate 10, 20, MPS 1200, Riteman Ct, Scribe, Star NB15, Star NL10, Star NX10, Star NX10C, Star SG-10/15, 1526/802. All these are on side 2!

**Questions:
Excelerator, Amiga,
C64 Business!**

Hey Guys!

I didn't get a reply for my last letter. Was it too long? Here's a short version.

Is the Excelerator FSD from Micro Accessories 100% compatible with C64 programs? I've heard ugly rumours to the contrary. What's a nice disk speeder-upperer?

Please! . . . tell me where I can see some of those nice programs you speak so highly of, like *Sculpt 3D*, *Digipaint*, databases and word-processors, AND get competent service with a smile. Everywhere I go I get taken by the nose and led gently to a waiting Atari . . . whose brochure states that Amiga can only sing as high as 7000

Hertz!! (True or False?)

My cousin wants some C64 business programs. Where can I expect GOOD service?

Sorry, I forgot . . . I was reading your FIDOnet article in your March edition, hoping to understand exactly what I must do to tap into FIDOnet. Yes, I know what I need: a computer, modem and terminal program - but I could not find the list of phone numbers I needed! And, where can I get hold of good terminal programs?

**Fabio Barone
Rosebery**

Ed - Yes, there were some problems with early versions of the Excelerator. However, there have been ROM upgrades - watch for news on that soon. As for service, and the programs you've been look-

ing for, try United Computers, 207 Clarence St, City. - And don't believe any of that Atari rubbish! (FALSE!) Business programs for C64 - try Pittwater Distributors on (02) 971-2990. Look in our ACR annual for phone numbers.

Nice modem mods

I read with interest the article in the March issue entitled, 'Nice-1650 - modifications'. In fact so interested was I that I modified my modem as suggested.

There was one point which was unclear. The article refers to terminal 'J' but the makers say DTR line is to go on pin 'E'. My Programmer's Guide also suggests the latter is correct.

My main problem however was that after making the modification

Maxwell

Office Equipment - Commodore Specialists

PC

Hardware and Software

Commodore's

Dealer of the Year

C128

Business and Utilities

C64

Business and Education

AMIGA

Hardware, Software and Accessories

SERVICE

Repairs, Mail-orders and Trade Ins

C64

Games and Utilities

162 - 4 NICHOLSON STREET, ABBOTSFORD 3067

SALES * TRADE-INS * HIRE * 419 6811



it didn't work! I could find no software intended for the 1650 which auto-answered or auto-delayed so the whole exercise was a bit of a waste of time, I use VIP XL as my normal terminal program. I did use the 'E' pin as I believed this to be the correct one.

Could you please put me in touch with the author of the article so I can get more details of the project and perhaps find out what I have done wrong.

In order to make more use of the chip I added a few minor extras which make it very convenient when calling auto baud seeking BBS's, and restore the modem to normal with one three way switch. I enclose a circuit diagram which may be of interest.

I would like to see more articles of this type in your magazine.

Bruce Lloyd Dapto

Ed - So would we! How about you technically minded people out there? We got the article on 1650 modifications from a local BBS - the author was unknown. Sorry - but we can't help. Try leaving a few messages around the traps, maybe somebody else has had your problem. Thanks for the improvements!

Illegal tracks & Doodle programs:

I won't bore you by telling you how good your magazine is or how long I've been reading it (1984).

What I would like is someone to HELP ME!

My first problem is this, I have been using *Easyscript* for about four years, and now I have a work disk which has a bug in the directory. How do I know it's got this bug, you may ask?

I keep getting a disk error "66, ILLEGAL TRACK OR SECTOR, 75,01". I don't wish to wipe out the whole disk as I have a lot of my students' handouts and assignments.

My second problem is that I have just changed my printer from an Epson brand to a Star NX-10c and I now find that Doodle will not output on this printer.

I was looking at the printer output screen and on the bottom there is a sign which reads Epson and Gemini version. (I am not a programmer, just a user of programs for my work). Again I have a lot of circuits on this program that I would like to be able to print out.

Can you HELP ME please with sugar on top.

If you can help me I promise to keep buying this magazine.

**Joseph Bajada
Rooty Hill**

Ed - First the bad news. Your disk is badly damaged - maybe irrevocably. If you can get hold of a program called Disk Doctor you may be able to recover the disk. As for your other problems - there should be a program on your Doodle disk to do the trick. Just select a standard Commodore printer. If you're really stuck, just give us a ring.

Write protected?

I purchased a program called *Speedreader II*. I took a back-up copy (one by using 'Copy Q' and one by using the nibbler). However none of the backups worked.

They defaulted out somewhere in the program. I did get a printout of the program from these backups - but can't get one from the original. I was hoping to improve my limited knowledge of BASIC by checking one against the other.

Now for my question - although the Backups didn't work I thought I would put a write protect tab on them and "Hey Presto" they worked. Just to be sure, I removed the write protect tab, and they, again, didn't work, but as soon as I put the write protect tabs on again they worked. What I want to know is WHY?

Keep up the good work with your magazine but, please, why do we have to wait (in Toowoomba) until almost the end of the month before we get our issues from our local newsagent?

**Jack Gibson
Toowoomba**

Ed - It is possible for a program to check that the disk is write protected before running - and it would appear that is what is happening. You've answered your own question! A simple form of copy protection - or you just fluked it. ACR is now on the newstands around the middle of the month all over Australia, So country areas shouldn't be far behind.

NICE MODEM MODIFICATION.

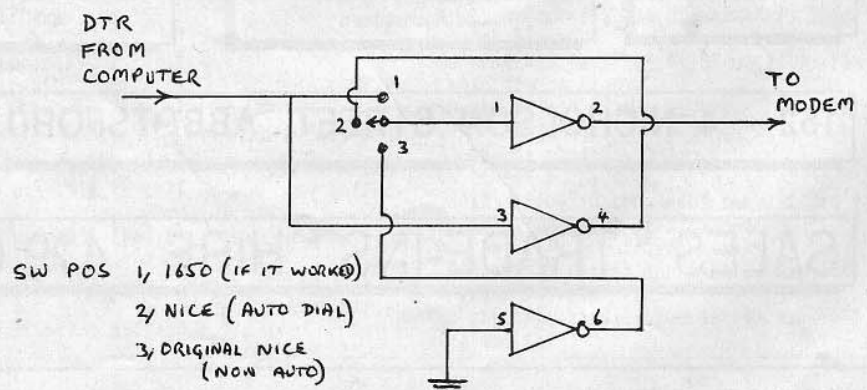



WARRIORS

AVAILABLE FROM MICROCOMPUTER SPOT, K-MART, GRACE BROS
AND INDEPENDENT COMPUTER STORES

Questor

THE CHALLENGE CONTINUES
TELEPHONE (02) 662 7944

Suite 64

Disk Magazine No 11

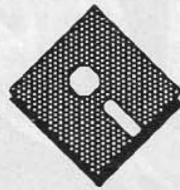

by Adam Rigby

With the release of Suite 64 in North America, we here at the *Australian Commodore and Amiga Review* have been able to improve the Disk magazine to a very impressive level. Complete with a "point and click" menu system utilizing icons, we have fashioned a system that is both easy to use and quick to load - something that is very important on the C64.

After assessing the American competition we found that a number of things are missing in their menu systems and content. We have a strict policy to supply our customers with more programs and less editorial - this has evolved for a number of reasons. One, it is very hard on the eyes to sit and read pages of editorial on the screen. Anyway, who wants to when most people already have the printed magazine.

In regard to the menu systems we have found that the American counterparts either overdo it or ignore it. We found that Loadstar took 90 seconds to load its menu system and that's a long time to wait for something that will allow you to choose another program to load! Suite 64 loads in 11 seconds which is far more practical. Plus the system we have set up is an operating system rather than a menu program - this means that any disk that has ADOS on it can be inserted when ADOS has been loaded.

A bit about ADOS

ADOS was written and designed by Andrew Farrell over a number of weeks in the quest to find the perfect C64 menu system. In a flash of genius Andrew used sprites as the icons and characters instead of hi-res for the background - simple, fast and quick. Using sprites instead of hires graphics has a number of distinct advantages. Speed is much improved, as is the loading time. Also the system tends to be more flexible and readily changeable. Also the ability to design the icons using a simple sprite editor makes life a lot easier. Also this allows the advantage of being able to design a whole series of sprites and archive them for use at a later date.

ADOS for you?

Well, this sounds great, but is it available to me for my other disks? Good question. We will soon be releasing an ADOSifying disk that will allow you to make all your disks boot up with ADOS. Also a disk full of ready-to-use Icons will accompany this to make ADOS a possibility for general use. ADOS has the distinct advantage of allowing beginners to access the full world of computers without having to read pages of information to get basic enjoyment out of their new toy.

What's on No 11

This issue we have made available a large number of DOS utilities such as:

Directory fix — This program is a quick and easy way to fix a disk that has a damaged directory without copying the whole disk.

Disk searcher — This allows the user to find various information in either HEX or Text form. This program is quite useful is general hacking.

Disk Tidier — Sick of disks full of rubbish you never use? Clean them up fast with this helpful spring cleaner!

1541 drive align — Well, well, a software driven drive aligner. Something new every day. This little wonder actually seems to work to the amazement of us all here at ACR.

Disk doctor — Initially from the Amiga disk doctor, this program helps you recover corrupted disks - something that happens quite often here. However, we hope that you never need this program.

Apart from these disk utilities we have a number of all-purpose utilities, that make life easier. For the programmers out there we have included an **80 column program** that will bring joy to your screen - 80 columns on the C64. The programmers here at ACR have found this program a real boon as they can follow their code - there is always a

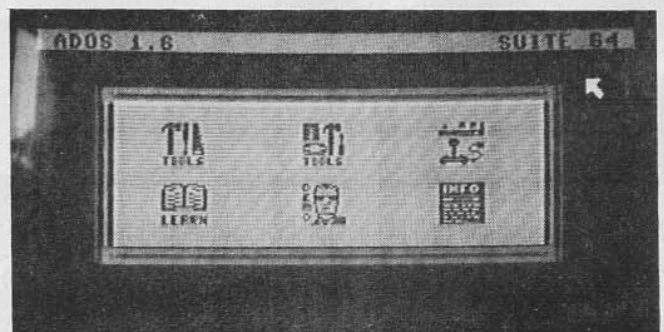
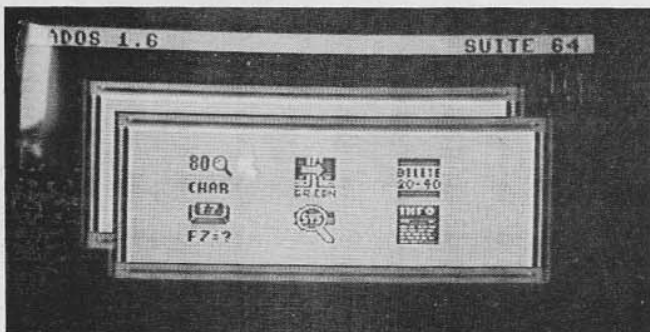

The Future of Disk Drives is Slim

Rec. Retail
\$299

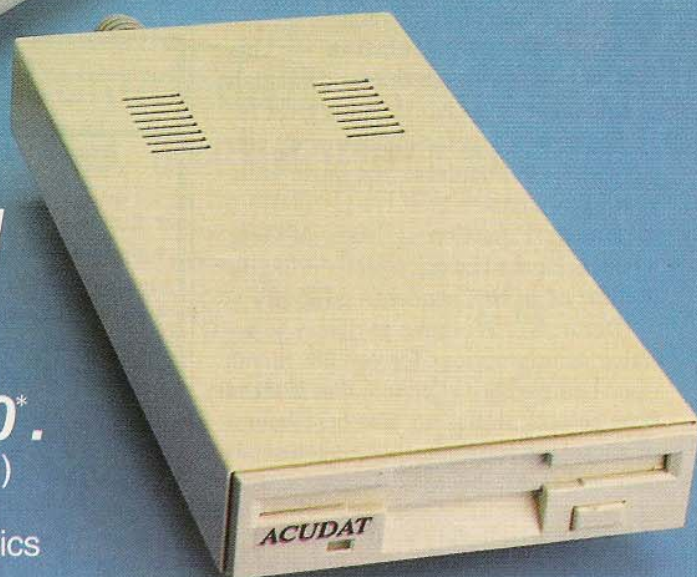
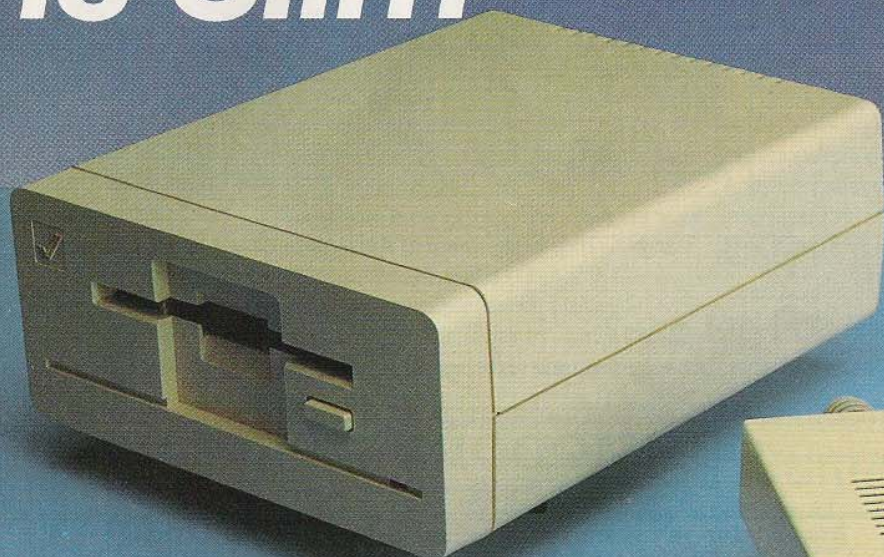

**Slimline, fast, best priced
The Acudat, for Amiga*
computers.**

Suits: A500*, A1000*, A2000*.

- Slimline compact Design (fits under A1000*)
- 20% Faster than Amiga 1010 Drive*
- High reliability using advanced LSI Electronics
- Quiet drive motor for silent operation
- Low Power consumption using CMOS Circuitry
- Superb accuracy using a precise mechanism and brushless drive motor
- Can be operated from A2000* bridgeboard
- External on/off switch
- Sturdy stackable construction

Trade enquiries welcome.
Call the national distributor:
H&R WHOLESALE PTY. LTD.
P.O. Box 4113, Parramatta, NSW 2150.
Tel: (02) 8971044

*Registered trademarks - Commodore Computers.

AVAILABLE FROM: FAIRSTAR COMPUTER CENTRE 293 Church Street, PARRAMATTA, NSW 2150. Phone: (02) 8911944 • FAIRSTAR COMPUTER CENTRE 143 Forest Road, HURSTVILLE, NSW 2220. Phone: (02) 5704555 • SYDNEY UNITED COMPUTERS 207 Clarence Street, SYDNEY, NSW 2000. Phone: (02) 295088 • COMPUTER FIX 2D Auburn Road, AUBURN, NSW 2144. Phone: (02) 6461666 • CHEAPER COMPUTERS P.O. Box 230, FIGTREE, NSW 2525. Phone: (042) 718228 • COMPUTECH COMPUTER CENTRE Unit 7, Church's Centre, Benjamin Way, BELCONNEN, ACT 2617. Phone: (062) 512525 • COMPUTECH COMPUTER CENTRE 8/14 Lonsdale Street, BRADDON, ACT 2601. Phone: (062) 571808 • COMPREPAIR MELBOURNE. Phone: (03) 3669404 • HANOD INVESTMENTS PTY LTD SOUTH AUSTRALIA. Phone: (087) 259533 • COMPUTER VIEW 21 Brisbane Road, BUNDAMBA, QLD 4304. Phone: (07) 2826233 • COMPUTER BYTES & P.C.'s 528 Ruthven Street, TOOWOOMBA, QLD 4350. Phone: (076) 384222 • J. MILLS AGENCIES Suite 4, 231 Balcatta Road, BALCATTA, WA 6021. Phone: (09) 3441660

first. Also for programmers we have included a **batch line delete program** that allows you to delete a group of lines at a time, something that Commodore was rather careless to leave out of BASIC 2.0 (along with everything else!).

Budding graphic artists can transfer their works of art between their various programs using the **Graphic Conversion** program included. Those who prefer to do Jigsaws instead of create master computer art, we can cater for you in this issue with a **jigsaw puzzle program** that accepts all major graphic formats and pulls them to bits for you to put back together. Those who actually enjoy this self torment are welcome to it.

Education — For those unfortunate people who are completing their HSC we have included some programs which may help them to justify using their computer when they should be studying.

Equation Manipulation — This program goes through the fundamentals of equation manipulation and is great for honing your skills for quick mental calculations. It is suitable for those from year 9 upwards.

Linear Equation — Many of these wonders have to be calculated during the lifetime of an HSC student - go to it!

Demos — We have two very interesting demonstrations for you this month - one being a classic picture that is taken from an optical illusion. The best feature of these programs is that you just sit back and enjoy.

GEOS

There is a huge amount of GEOS owners out there that have been ignored too long and we have included a full disk of Printer drivers that will quench your thirst. These include: Bluechip M120, C.Itoh 8510, C.Itoh 8510a, Commodore Compatible, Epson FX-80, Epson MX-80, Epson JX-80, Gemini 10X, HP Laserjet, IBM 5152+, Imagewriter, Imagewriter II, MPS-801, MPS-1000, OKI 120, Olivetti PR2300, OKI ML -92/93, Okimate 10, Okimate 20, MPS 1200, Riteman C+, Scribe, Star NB-15, Star

*How do you
make water
run uphill?
See our
classic hires
optical
illusion
picture*

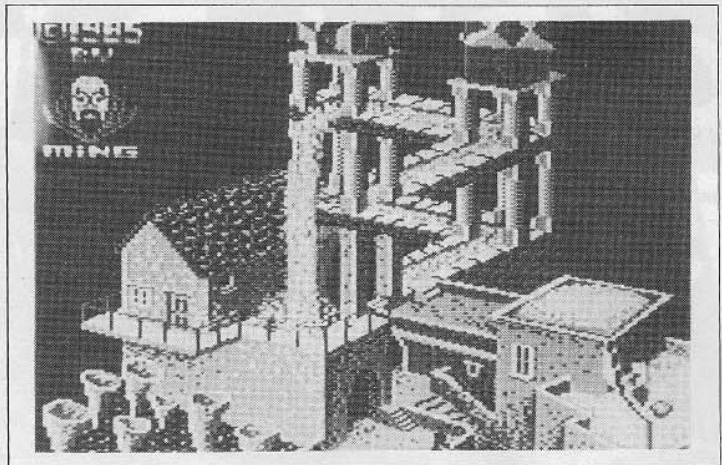

NL-10, Star NX-10, Star NX-10c, Star SG-10/15, 1526.

here at *Australian Commodore and Amiga Review* on (02) 398 5111 and order, we can take Bankcard over the phone. ■

How do I get one?

That's the easy bit - Just phone us

COMMODORE 64/128 Education Pack

A must for ANY student at High School or University!

★ MATHS PACK ★

- * High-Resolution Graph Plotting
- * Numerical integration/differentiation/ equation solving
- * Solve simultaneous equations (with up to 40 equations and 40 unknowns)
- * Numerical solution of first order differential equations
- * Least square curve fitting
- * Conic Analysis and much more

★ ENGLISH/FRENCH

TRANSLATOR ★

Translate English to French and French to English!

★ FOR ENTERTAINMENT ★

SULTAN'S PALACE

This is the big one for which the reward was offered (claimed)

TALKING SAM

Your friend in the computer

TANK BATTLE

SUBMARINE GRID CHASE

★ STAR PACK ★

A planetarium display of the heavens from anywhere on earth

★ MUSIC MAKER ★

Play ANY piece of Sheet Music in one to three voices. A good way to learn Music Principals

★ SCALE YOUR OWN EXAM MARKS ★

This program will correctly add and scale marks to required weights, standard deviation and mean

★ THE ODDS PROGRAM ★

How to bet on a large number of horses and win a set profit (No Matter What)

★ SPRITE MAKER ★

A useful and SIMPLE TO USE little program to create Sprites and multi-sprites and their Data

You get **THE LOT** on one disk for **\$24.95** FROM

GARY McCLEARY SOFTWARE
P.O. BOX 24, EMU PLAINS, N.S.W., 2750

Graphics Label Wizard

A label maker for the Commodore 64 *Reviewed by Eric Holroyd*

ANOTHER VERY useful utility programmed by Cornucopia Software (remember their *SuperCat*, the disk cataloging system which sells for the same price?), this label maker really works well. Many outlets offer label makers, some are pretty basic and not many offer the facility to include graphics from a variety of art programs.

Label Wizard is menu-driven, very easy to use, and even prints out its own instructions from a file on the program disk. You can use *Print Shop*, *Printmaster*, *Software Solutions* etc (and graphics compatible with these formats) plus up to eight lines of text. There's an additional batch of graphics included on the program disk plus an alphabet of initials in capital letters.

The label you design can be displayed in high resolution on your screen so that you can see exactly what it's going to look like before you print, then you can (S)ave the label on your data disk (which can be formatted from within *Label Wizard* if you forgot to format one beforehand) for future use. It's great to be able to do reprints anytime without having to re-design the job from scratch. Of course, you may re-design an existing label if you wish.

Printers

The printer "definition" files on the master disk are for Commodore-compatible and Epson-compatible printers. Most printers should work with one of these



but if you can't get your printer to work properly you're able to build your own printer definition with help from the instructions (which will also display on screen.) Commodore printer users get a bonus here because they're able to use the "non-Commodore" side of *Print Shop* disks and thereby get access to graphics not previously usable.

In the unlikely event of your not being able to get your printer working at all, you're invited to write to Cornucopia Software with your problem and they'll be only too happy to help. Seems to me that they've covered everything properly and it's nice to know that after-sales help is available if required.

Designing a label

When designing a label you may load up to four graphics to memory and swap between them until you're happy with your label.

Epson-type users then have a choice of 10 fonts (or type-styles) to print in, and you get to select the font you want for each line of text. Users of Commodore printers have a more restricted set of fonts corresponding to the features available on 1525 and MPS801 printers.

Select from 1-9999 prints of the same label and off you go. You may

choose to "print the label on the screen" or "print label from disk", or even "print all labels from disk" in the case of a mailing list. This is handy if you do a newsletter mailing or similar, as each label definition is loaded from disk then one copy printed, and the whole job is done automatically. It's not the fastest label printer I've ever seen but it certainly does the fanciest labels. A blank data disk can hold up to 73 label definitions by the way.

Cataloger

In addition, there's a useful program on the master disk which is called Cataloger. This reads in all the graphics from a disk and prints "library sheets" with 7 rows of 4 graphics across, that's 28 to a page, complete with their names. You can now see what all those graphics you've collected look like and use the most appropriate one for the job when designing labels.

The instructions include some useful suggestions for labels in addition to the mailing labels that we're all familiar with. They include:

Lunchbag labels



CORNUCOPIA SOFTWARE
P.O. Box 2638
Portland, OR 97208



The BOSS!
Australian Commodore Review
RANDHICK, NSW 2031
This label made with "LABEL WIZARD"

Pactronics Price List

C64 Business Software

KWIK-WRITE	disk	\$39.95
A full featured word processor		
KWIK FILE	disk	\$19.95
Ideal database for first time user		
KWIK CALC	disk	\$19.95
Spreadsheet program for beginners		
KWIK PAD	disk	\$19.95
Desktop organisers. Calculator, diary etc		
KWIK CHECK	disk	\$19.95
Cheque reconciliation & expense analysis		
KWIK UTILITY	disk	\$19.95
Deluxe DOS utilities, disk based fast loading		
MINI OFFICE II	disk \$54.95 tape	\$45.95
Six-in-one business program; WP, spreadsheet		
MAGPIE DATABASE	disk	\$69.95
Powerful programmable data management		
SWIFT SPREADSHEET	disk	\$69.95
Best selling spreadsheet - 64 /128 on one disk		
INSTANT RECALL	disk	\$49.95
Speedy database, stores records in RAM		
WORD PERFECT	disk	\$69.95
Easy to learn, powerful word processing		

C64 Utility Software

BECKER BASIC	disk	\$99.95
New Basic - programming in Basic under Geos		
GEOSMAN - BOOK & DISK SET	disk	\$69.95
Instruction manual with disk utilities		
D-CODER / N-CODER	disk	\$24.95
Easiest way to interpret Machine Code		
TOOL BOX 64/128	disk	\$24.95
Full of useful sub routines		
MASTERLOCK	disk	\$16.95
Foolproof security - stops ALL copiers		
BLITZ COMPILER	disk	\$44.95
Speed up your Basic programs up to 2000%		
D-COMPILER	disk	\$44.95
Converts a Blitz program back to Basic		
DIR+	disk	\$24.95
Excellent disk cataloguing program		
PARAMETER PAK	disk	\$24.95
100 parameters for hard to back up programs		
KWIK LOAD	disk	\$19.95
Complete disk utilities package		
PRINT POWER	disk	\$59.95
Multi fonts, font options, border options		
AWARD WARE	disk	\$39.95
Design certificates, banners, cards etc		
1541 MASH II	disk	\$49.95
Align your own disk drive		
PHOTOCOPY	disk	\$39.95
Converts Print Shop to Newsroom or Doodle		

C64 Educational Software

SCHOOL SOFTWARE		
MAGIC MATHS	(AGE 3-7)	
GEOGRAPHY	(AGE 12-16)	
MATHS MANIA	(AGE 8-12)	
BIOLOGY	(AGE 12-16)	
BETTER SPELLING	(AGE 9-Adult)	
PHYSICS	(AGE 12-16)	
BETTER MATHS	(AGE 12-16)	
CHEMISTRY	(AGE 12-16)	
disk	\$18.95	tape \$14.95

SESAME STREET

Superb range of educational programs. Covers problem solving, predicting, logic and reasoning		
ERNIES BIG SPLASH	(AGE 4-6)	
GROVERS ANIMAL ADVENTURES (AGE 4-6)		
ERNIES MAGIC SHAPES	(AGE 4-6)	
ASTRO GROVER	(AGE 3-6)	
BIG BIRDS DELIVERY	(AGE 4-6)	
PALS AROUND TOWN	(AGE 4-6)	
	disk	\$49.95
LCL MICRO MATHS	disk \$49.95 tape	\$39.95
Advanced maths (Year 9-11)		

ARRAKIS ADVANTAGE SOFTWARE

ALGEBRA 1 / VOLUME 1 - SETS & NOTATIONS		
	disk	\$49.95
Sets, set notation, set types, operations etc		
ALGEBRA 1 / VOLUME 2 - NUMBER SYSTEMS		
	disk	\$49.95
Number uses, subsets, operations on integers		
ALGEBRA 2 / VOLUME 1 - EQUATIONS AND FORMULAE		
	disk	\$49.95
Terms and expressions, equations, inequalities		
ALGEBRA 2 / VOLUME 2 - LINEAR EQUATIONS		
	disk	\$49.95
Linear equations, systems of equations, functions etc		
ALGEBRA 3 / VOLUME 1 - POLYNOMIALS		
	disk	\$49.95

Operations on polynomials, rational functions, roots etc		
BIOLOGY 1 - RESPIRATION		
	disk	\$49.95
Mechanics of breathing, oxygen transport etc		
BIOLOGY 2 - DIGESTION AND NUTRITION		
	disk	\$49.95

Nutrients, digestive system, health, nutrition etc		
BIOLOGY 3 - REPRODUCTION AND DEVELOPMENT		
	disk	\$49.95
Male & female reproductive systems, etc		
BIOLOGY 4 - CIRCULATION AND THE HEART		
	disk	\$49.95

Blood, veins, , arteries, lymph glands etc.		
CHEMISTRY 1 - THE ATOM		
	disk	\$49.95
Dalton's, Thomson's, Rutherford's & Bohr's models, tables etc		
CHEMISTRY 2 - THE PERIODIC TABLE		
	disk	\$49.95

Periods, periodic law, periodic properties etc		
GEOMETRY 1 - BASIC GEOMETRY		
	disk	\$49.95

Perimeter, area, volume, point, line, plane etc		
GEOMETRY 2 - PLANE AND SPACE GEOMETRY		
	disk	\$49.95

Circles, polygons, triangles, quadrilaterals etc		
PHYSICS 1 - MOTION		
	disk	\$49.95
Speed and velocity, acceleration, mass etc		
PHYSICS 2 - LIGHT		
	disk	49.95

Waves, particle theory, speed, wave theory		
STATISTICS 1 - INTRO TO DESCRIPTIVE STATISTICS		
	disk	\$49.95
Sampling, inferential statistics, probability etc		
TRIGONOMETRY 1 - INTRO TO TRIGONOMETRY		
	disk	\$49.95

Trigonometric functions, right angles, sine, etc

C64 Graphics

MAGIC MOUSE	mouse and disks	\$129.00
Includes driver routine for GEOS + software		

MAGIC MOUSE	set	\$69.95
Mouse with multi-function software		
ARTIST 64	disk	\$89.95
Advanced graphics program for the C64		
KWIK PAINT	disk	\$12.95
Simple to use drawing program, ideal for kids		
BLAZING PADDLES	disk	\$69.95
Complete with lightpen, ideal for children		

C64 Entertainment Software

CLASSIC QUEST		
Series of text only adventures, easy to hard.		
GOBLIN TOWERS - reasonably easy		
FORESTLAND - fairly difficult		
WITCH HUNT - difficult		
CATACOMBS - not for beginners		

	disk	\$49.95
ALL STAR TEST CRICKET (C64/128)		
	disk	\$39.95
New, enhanced version of Graham Gooch's Test Cricket		
IMPACT	disk	\$39.95

Best selling arcade-type game comes to the 64.		
TIME AND MAGIK disks \$39.95 tapes \$29.95		
Complete trilogy of level 9 graphic adventures		
WHEEL OF FORTUNE	disk	\$34.95
All the features of the original game show.		
JEOPARDY	disk	\$29.95
Adaption of the popular TV game show.		
FAMILY FEUD	disk	\$29.95
All the drama and excitement of the TV game.		
CONCENTRATION	disk	\$29.95
Test your memory in this version of the classic.		

C64 Peripherals

PACTRONICS DISK DRIVE		\$349.00
Replacement for 1541 Commodore disk drive.		
DATASETTE		\$59.95
Ultra reliable, with red LED light		
FINAL CARTRIDGE III		\$139.95
Many features to numerous to list.		
ACTION REPLAY MK IV		\$149.95
The ultimate add-on cartridge.		
MOUSE/CHEESE SET		\$129.00
Best mouse for the C64. With own software.		
MAGIC MOUSE	set	\$69.95
Mouse with multi-function software		

PC Business Software

PROTEXT PC	disk	\$199.00
Professional Word Processing		
PROTEXT FILER	disk	\$69.95
POP-UP database module for PROTEXT		
PROTEXT OFFICE	disk	\$99.95
Pop-up add-ons for PROTEXT, mail merge etc		
EVERYMAN'S ACCOUNTING SYSTEM	disk	\$149.00
Small business accounts, debtor, creditor etc		
MONEY MANAGER PLUS	disk	\$99.00
Cash book, personal accounts system etc.		
TOP COPY	disk	\$149.00
Windowing, multi-document word processing.		

These products are available from your local retailer (see inside cover)

RAM JET EXECUTIVE
(AMSTRAD PC 1512 ONLY) disk \$189.00
Disk cache, print buffer, screen accelerator etc
SNIP INTEGRATED ACCOUNTING
disk \$499.00
Total financial control. Debtors, creditors, etc
TOP COPY PLUS disk \$299.00
Advanced word processing.
DIAMOND disk \$249.00
Spreadsheet, Graphics, and word processor.
TWIN ADVANCED disk \$189.00
Spreadsheet, Database and Graphics.
CHARTMAN disk \$129.00
Brilliant Business graphics program.
HS-2000 HANDY SCANNER \$599.00
Best value text and graphics scanner around.
200 DPI, 105mm scanning width. Complete with
Halo Desktop Publishing Editor to edit and add
MINI OFFICE PROFESSIONAL PC
Integrated program for your PC \$189.00
Absolutely the best!
BUSINESS TOOLS disk \$49.95
77 business forms, 33 contracts, 105 letters.
EASY DOS disk \$49.95
On-line MS DOS tutorial.
PRINT POWER disk \$69.95
Multi fonts, font options, border options.
AWARD WARE disk \$49.95
Design certificates, banners, cards and more

ABACUS INSTANT REFERENCE BOOKS
Clear and concise information on a wide range
of MS-DOS programs
DBASE III Full command and instruction set.
LOTUS 1-2-3
Clear instructions for the standard spreadsheet
MICROSOFT WORD
Uncluttered command summary.
MS-DOS 3.3
Caters for all versions including DOS 3.3.
GW-BASIC Comprehensive instruction tutorial.
WORD PERFECT The perfect accompaniment.
All above books \$24.95
Example programs demonstrate principles.
SCIENCE AND ENGINEERING book \$49.95

PC Educational Software

SCHOOL SOFTWARE

A range of entertaining, educating software
MAGIC MATHS (AGE 4-8)
MATHS MANIA (AGE 8-12)
BETTER MATHS (AGE 12-16)
BETTER SPELLING (AGE 9-ADULT)
MAXI MATHS (AGE 12-16)
CHEMISTRY (AGE 12-16)
BIOLOGY (AGE 12-16)
PHYSICS (AGE 12-16) disk \$39.95
SESAME STREET
Superb educational programs. Covers problem
solving, predicting, logic and reasoning.
ERNIES BIG SPLASH (AGE 4-6)
ASTRO GROVER (AGE 3-6)
GROVERS ANIMAL ADVENTURES (AGE 4-6)
BIG BIRDS DELIVERY (AGE 3-6)
ERNIES MAGIC SHAPES (AGE 4-6)
PALS AROUND TOWN (AGE 4-6) disk \$39.95

CHINEASE disk \$69.95
Learn how to write and speak Mandarin
Chinese.
MICRO MATHS disk \$69.95
Advanced maths program, for older students.

ARRAKIS ADVANCED SOFTWARE
ALGEBRA 1 / VOLUME 1
SETS AND NOTATIONS disk \$59.95
Sets, set notation, set types, operations etc
ALGEBRA 1 / VOLUME 2
NUMBER SYSTEMS disk \$59.95
Number uses, subsets, operations on integers.
ALGEBRA 2 / VOLUME 1
EQUATIONS & FORMULAE disk \$59.95
Terms and expressions, equations, inequalities.
ALGEBRA 2 / VOLUME 2
LINEAR EQUATIONS disk \$59.95
Linear equations, systems of equations etc
ALGEBRA 3 / VOLUME 1
POLYNOMIALS diisk 59.95
Operations on polynomials, rational functions.
BIOLOGY 1 - RESPIRATION disk \$59.95
Mechanics of breathing, oxygen transport etc
BIOLOGY 2 -
DIGESTION AND NUTRITION disk \$59.95
Nutrients, digestive system, health, nutrition etc
BIOLOGY 3 - REPRODUCTION AND
DEVELOPMENT disk \$59.95
Male and female reproductive systems, etc
BIOLOGY 4 - disk \$59.95
CIRCULATION AND THE HEART
Blood, veins, capillaries, arteries, lymph glands.
CHEMISTRY 1 - THE ATOM disk \$59.95
Dalton's, Thomson's, Rutherford's and Bohr's models,
tables etc.
CHEMISTRY 2 -
THE PERIODIC TABLE disk \$59.95
Periods, periodic law, periodic properties etc
GEOMETRY 1 -
BASIC GEOMETRY disk \$59.95
Perimeter, area, volume, point, line plane etc
GEOMETRY 2 - PLANE AND SPACE
GEOMETRY disk \$59.95
Circles, polygons, triangles, quadrilaterals, etc
PHYSICS 1 - MOTION disk \$59.95
Speed and velocity, acceleration, deceleration.
PHYSICS 2 - LIGHT disk \$59.95
Waves, wave interaction, particle theory, etc
STATISTICS 1 - INTRO TO DESCRIPTIVE
STATISTICS disk \$59.95
Sampling, inferential statistics, probability etc.
TRIGONOMETRY 1 - INTRO TO
TRIGONOMETRY diisk \$59.95
Trigonometric functions, right angles, sine etc
BUSINESS DYNAMICS disk \$39.95
A complete business primer.
COMPUTEREASE disk \$39.95
Tutorial on how to use a PC, printer, disks etc

PC Games Software

TRILUM ADVENTURE GAMES
AMAZON disk \$59.95
Based upon the novel by Michael Crichton.
FAHRENHEIT 451 disk \$59.95
Bring the written word back from the brink of
extinction.

PERRY MASON AND THE
MANDARIN MURDERS disk \$59.95
Who did it?
CLASSIC QUEST
Five text adventures from beginners to nearly
impossible. disk \$39.95
GOBLIN TOWERS - Reasonably easy
FORESTLAND - Fairly difficult
WITCH HUNT - A difficult adventure
CATACOMBS - Definitely not for beginners
CORNUCOPIA - Gigantic and complex
IMPACT disk \$59.95
Best selling arcade-type game comes to PC's.
STARQUAKE disk \$59.95
Over 500 screens full of animated action.
TIME AND MAGIK disk \$59.95
Complete trilogy of level 9 graphic adventures.
WHEEL OF FORTUNE disk \$59.95
All features of original game show.
JEOPARDY disk \$49.95
PC adaption to the popular TV game show.
FAMILY FEUD disk \$49.95
Play Fast Money just like the TV original.
CONCENTRATION disk \$49.95
Exciting PC version of Classic concentration!

Amiga Business Software

DATARETRIEVE disk \$159.00
Full database, with easy to use interface.
BECKERTEXT disk \$299.00
Superb full featured word processor.
TEXTPRO disk \$99.95
Simple to use full featured word processor.
ASSEMPRO disk \$189.00
Assembler, monitor, disassembler, editor etc.
PUBLISHER PLUS disk \$189.00
Improved version of this desk top publishing
program..
EXPRESS PAINT VERSION 2.20 disk \$149.00
Painting editing with 64 colours in low res!

Amiga Books and Manuals

PRESENTING AMIGA book \$19.95
A beginners guide
AMIGA FOR BEGINNERS book \$39.95
Every detail required to get used to Amiga.
AMIGA TRICKS & TIPS book \$49.95
Library calls, animation, sound, IFF graphics etc
AMIGA MACHINE CODE book \$49.95
Guide to learning 68000 machine code.
AMIGA BASIC INSIDE & OUT book \$49.95
Guide to Amiga Basic with heaps of programs
AMIGA DOS INSIDE AND OUT (COMING
SOON) Price on request
Complete guide to the Amiga operating system.
AMIGA SYSTEM PROGRAMMERS GUIDE
(COMING SOON) Price on request
Everything you need to program your Amiga.

Amiga Games

TIME AND MAGIK disk \$59.95
IMPACT disk \$49.95
MORTVILLE MANOR disk \$69.95
The greatest detective game with speech ever
made.

These products are available from your local retailer (see inside cover)

Home canned fruit and vegetable labels

- Personalized book plates
- Home bottled wine and beer labels
- From the desk of . . . labels
- Kitchen canister labels, etc etc.

Label Wizard is set up to print on standard mailing labels and allows you to use from 1 to 4 across. Multiple labels may only use standard font however, and should also be 3.5 inches wide by 15.16 high, with 1.8 inch vertical spacing between labels. To use all the fonts you should therefore use single labels. Personally, I've used 2-across labels but only printed the left-hand one, then turned the sheet of labels upside down (after printing one batch) to print some more.

All in all I found this a most satisfactory utility and I got very good results with the minimum of fuss. My Gemini

10X worked okay with no modifications necessary to the Epson printer definition and a colleague owning a Citizen 120D used the Epson file with the same high degree of success.

If you haven't yet got a good label printing utility, or are looking to replace a basic one with something better, then try this one. I'm sure you'll be happy with it.

To further enhance this fine utility, and your collection of suitable graphics, there are currently four graphic library disks available at \$14.95 (US) each. Every disk contains 100 graphics, with *Print Shop* format on one side and *Printmaster* format on the other.

The *Label Wizard* is distributed by Westend Computers (03) 350 5144 for a RRP of \$45.00. ■

20 FOR X=1024 TO 2023: POKE X, 1:
NEXT

Save it, because you will need to use it later, and then RUN it. Nothing should appear to happen. But, when it is finished, run the cursor over the screen - you will be able to see the 'A's under the cursor.

Now type in the Moderniser program at the bottom of the page, save it, and then run it.

What the machine code routine does is transfer the KERNAL into the free RAM below it. Line 100 changes the routine that causes our "problem" so that the computer is now like a post January 84 one. Line 110 switches out the old KERNAL, and switches our "new" one in. Clear the screen, move down a bit, and type POKE1024,1 again. A light blue 'A' should now appear like it does on the newer 64s.

Reload the two line program from before and run it. It should work perfectly.

Unfortunately, this program will not work if another program is being used, use the area below the KERNAL. So my suggestion to you is to copy this "new" kernal onto an EPROM chip (see June issue) and then replace the old chip with this.

And finally, to new 64 users, when you write programs for magazines to use pre-84 users a favour and either make them compatible with this, or make sure you use the colour memory whenever you use the screen memory! ■

Modernising your 64

by Paul Dwerryhouse

COMMODORE MADE many versions of the good old C64. These ranged from the original 64 to the Executive SX64, and finally to today's C64c. But some 64s have internal differences that are not widely known. One of these concerns 64s that were made before January 1984.

To find out approximately when your 64 was made, turn it on, clear the screen, and move the cursor down a few lines with the cursor keys. Now type POKE 1024,1 and then press [RETURN]. If your computer was made after January 1984, an 'A' should come up in the top left hand corner, coloured light blue. If yours was made before that date, the 'A' that appears will be coloured dark blue, thus rendering it invisible against the dark blue background.

The "problem" lies in the KERNAL chip which was updated by Commodore around that time. The routine that was changed originally made the colour mem-

ory exactly the same colour as the background whenever the screen was cleared. Nowadays, the colour memory is made the same colour as the cursor.

This change makes any programs using screen memory without colour memory unusable on old 64s, yet they seem to work well on new ones. If your 64 is an old one, type this in:

10 PRINT CHR\$(147)

```

5 REM ***      C64 MODERNISER      ***
6 REM *** BY PAUL DWERRYHOUSE ***
7
10 FOR I=49152 TO 49193: READ A: POKE I, A: B=B+A: NEXT
20 IF B<>7594 THEN PRINT "ERROR IN DATA": STOP
30 DATA 169,0,133,251,169,160,133,252
40 DATA 169,0,133,253,169,224,133,254
50 DATA 160,0,177,251,145,251,177,253
60 DATA 145,253,200,192,0,200,243,230
70 DATA 252,230,254,166,252,224,192,200
80 DATA 233,96
90 SYS49152
100 POKE58587,134:POKE58588,2
110 POKE1,PEEK(1)AND253

```

L.A. Crackdown

reviewed by
Eric Holroyd

In this third release from the Epyx "Master's Collection" you're an ace drugs detective (the manual said "crack narcotics investigator" which I thought was a lovely pun!)

Your brief is to search out and smash a Los Angeles drug gang believed to be operating from the Pacific Shipping Company's warehouse.

To help in the task you choose an assistant from four "rookie" cops whose data files are displayed on screen. Their names, height/weight, police history and social outlook etc are there to help you decide on a partner. I liked the idea of No 4, Felix Schwarzenegger. He sounded so big and strong, just the guy to have along when you're crime-busting in LA!

Start the game by choosing where to send the surveillance van from LAPD HQ. The manual advises the first menu choice as "go to" and then "warehouse". Choose with your joystick, although there are keyboard equivalents if you prefer.

Once at the warehouse you stay in the van and send the dummy (sorry, rookie!) inside to check out the scene. The screen display is very good with the top half divided vertically to show both the view from the van and what the rookie himself sees. Below that is a four-section display showing a plan of the warehouse, the options menu, a bug monitor and a clock/calendar. All this info comes back to you whilst you're safely ensconced in the van so all you have to do is direct the rookie's actions and evaluate everything for further action . . .

Your rookie can carry out all sorts of tasks (Search, Take a picture, Arrest, Plant a bug, Review, Identify etc) which are directed by your choices from the options menu and he can plant up to four electronic bugs to help gather information. You can record the suspect's tele-



phone calls on your van equipment via one of these bugs and even have him pick bugs up again to relocate for checking out more suspects. He'll interview suspects and arrest them too if you tell him.

You're advised to give him a rest every 12 to 16 hours or he may quit the job, so watch the clock/calendar display which tells elapsed time since the investigation started. You can "compress" time if your rookie is watching a suspect who's gone off to sleep for instance and save yourself the trouble of sitting there with no action. The correct time is still logged however.

I found it best to take notes as I went along. There's so much detail in this game that I couldn't remember some of the vital things that had happened and so made wrong judgements. It's a very good action strategy game



and you need to be on your toes all the time.

The very helpful booklet has plenty of game-play hints, as well as many LAPD case histories of suspects from Criminal Records. Study these carefully when planning your strategies and it'll pay off. When all the evidence is in and you think you have enough to go on, you may get the rookie to arrest the ring-leader, but watch out he doesn't make an escape attempt!

I found this to be a very good game and I liked it a lot even though I'm not usually into adventure/strategy games. This one's different as there are very good graphic displays of what's going on (even down to a winking dot on the map when the surveillance van is going to a new location) and it was quite absorbing.

There's a "save" feature so that the current investigation can be stored on a data disk for later game-play, a good inclusion as you could easily play one game over several sessions. Incidentally, there's no typing involved (except for Y or N) as the choices are all on the screen.

I didn't like the copy protection used and in fact found it most annoying. Both sides of the disk rattled the heads on the 1541 drive, something which always disconcerts me, and I'd like to think that Epyx would use some other form of copy protection on future releases.

Our review copy came from Questor (02) 662 7944. ■

Skate Crazy

by David Smith

"Freddy's the name and skating's the game", according to the introduction to Skate Crazy. While playing this game you begin to realize that "crazy" just isn't the word for it.

The aim of this arcade-type game is to buzz young Freddy and his little skates around one of two courses: the "Car park Challenge" or the "Championship Course", and to gain "street cred" on your "credometer". Trying to impress the judges also helps.

Freddy is reasonably easy to control in the Car Park Challenge, where you have to skate through gates, jump tires, and dodge those annoying little remote controlled cars. This game also thoughtfully supplies ramps which you are to jump, and perform tricks and stunts on, in mid-air. The judges seem to like nice little twists and turns in your jump, therefore leading to a higher total score.

Championship Course is a little harder where Freddy must dodge and duck obstacles in a building site. He must also look out for angry "brickies", who occasionally chuck bits of brick at him.

In level two Freddy crosses a lake to a park, where he must dodge the quite amusing deadly wildlife.

I'd like to tell you about levels three

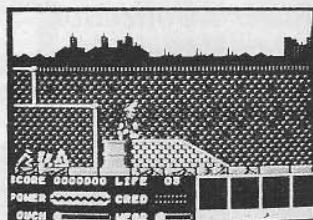

and four, but, you know how it is, Freddy likes to lose his lives just too often.

The graphics in this game are quite good. From behind Freddy looks as though he is skating. The lads from Gremlin Graphics have done quite a good job on likeable little Freddy, with his pleasing hat and sunnies. Movement is a little bit limited, and Freddy sometimes

just does not want to be told where to go, (a mind of his own, you might say).

Championship Course has nice scenery, but the brickies' faces leave a lot to be desired. Sound and music too, is pleasing.

One thing that strikes the player, (well, it struck me) as strange is the inability to jump over obstacles on the course, so I decided to stick to skating round them, which incidentally, the judges do not seem to like, making you lose some points. Other than losing points, it's not hard to rate highly in the "ouchmeter", which is not a good thing.

Overall, this game has a good story line, but I'm sorry to say has that little something lacking. Compared to some other C64 games, such as *Skate or Die*, this one is just not up to scratch, but if you like that dodge and jump sort of thing you might just enjoy *Skate Crazy*.

Review copy came from OziSoft (02) 211 1266. RRP - cassette \$29.95 and disk \$39.95. ■

Arac & the Arachnidroid

by Eric Holroyd

This is one of those English arcade adventures full of strangeness but very colourful creatures. It's really a ladders and platform game with on-screen puzzles to solve plus bits and pieces to collect.

The hero is Arac, a droid who bounces around quite nicely looking a bit like an underwater Thingonaspriug. He can glide right or left and can also fire little nets to entrap the various beasties floating around. Once trapped, the creatures are imprisoned in a cage until Arac wants them to help him do something. They'll help him do one thing only and get their freedom in return.

You have to guide Arac around the 100 screens to find various components which will transform him into the Arachnidroid (a creature with devastating powers) whose main take in life is to find and deactivate three reactors deep inside the underwater fortress. He can do this either by zapping his way through everything or by using the captured creatures with a mixture of strategy and plan-

ning. A bit of both would be the best way to go here, I think.

This game came to me on cassette and its inlay had all the game instructions as well as a description of the creatures. A weird mixture of English and German was used here and I must confess that I liked some of the German names of the beasts better than the English ones.

For instance: Rock Hopper came out as "Der Kraftige Hupfer", Big Borer was "Der Grosse Langweiler" but my favorite was one called the "Malevolent Man of War" which in German was "Das Kriegerische Boswillige Ding". Has a nice resounding ring, doesn't it?

The rest of the creatures include: A Stingray, a Robot Guard, and a Stinger. all these things have different powers which Arac can get them to utilise on his behalf. Big Borer is described as being bad-tempered but if he's pointed in the right direction he can gnaw right through a wall, very useful to Arac in his quest through the citadel. The Malevolent Man of War has the very handy facility to defuse delicate electronics which is also helpful when Arac is trying to knock out the fortress's radar and other stuff.

There's a nice on-screen display below

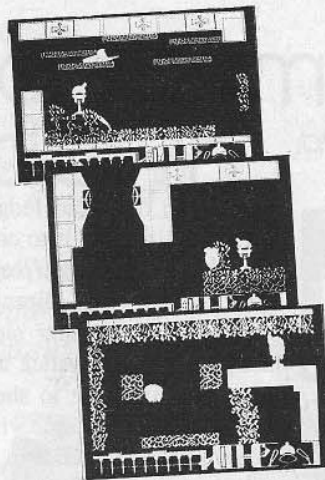

the play area showing Arac's status and energy percentage and to the left of this is the cage where the "netted" creatures swim around awaiting Arac's call. The whole thing is quite colourful and playable with a reasonable amount of lasting interest involved. Play it with joystick or keys from either cassette or disk.

If you're into arcade adventures you'll probably like this one as it has some unusual features including icons and pointers to make selections.

Review copy from YPA (02) 899 2277, RRP C\$12.95 D\$19.95. ■

Nebulus by Phil Campbell

Demolitions never work. Not the first time, anyway. I once stood in a crowd, waiting to see an old building blasted. Unfortunately, it didn't work. Eventually, we all went home. Even the TV news crew, who desperately needed something interesting to fill that little gap after the weather report.

Nebulus is a very unusual Commodore 64 game. In it, you play the part of a small, green, frog-like demolition expert. You are frog-like because everyone on the planet Nebulus looks this way. Nothing personal. Like Sydney in the autumn, Nebulus is a very wet place.

Eight giant towers have mysteriously appeared in the sea. As they were built without proper planning permission - probably by a Japanese consortium - they must be demolished. That is your job.

As the highly trained field expert of Destructo Incorporated, you must travel from tower to tower in your mini-submarine, climb to the top of each one, and activate a special destruction sequence. But this is far from easy.

Each cylindrical tower is covered with a network of ledges, tunnels and lifts. You must work your way up, avoiding bouncing eyeballs, flying molecules and other hazards, in less than 100 seconds.

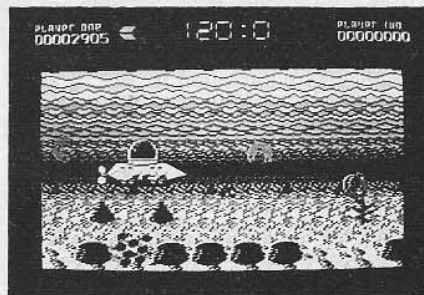

Otherwise, it is back to the bottom - and you have only two more chances before the game ends.

If you get bounced or bumped by an obstacle, you will fall. Exactly how far depends on what is underneath you - perhaps just a level or two, or maybe into the sea below. Points are awarded for shooting bouncing balls and flashing blocks, with extra points if you complete the climb on time.

The manual promises a bonus "fish catching expedition" between towers. It sounds like fun, and I wish I could tell you what it was like. But I am still trying to get to the top of the first tower.

Nebulus features "rotational 3D scrolling". This is unique. As you move around the outside of the tower, the screen display rotates to keep up with you. This is a very clever piece of pro-

gramming, and to make sure that we all appreciate it, the manual points out the technique uses "precise hidden surface removal running at 25 frames per second".

As well as being clever, the game is visually appealing. The cartoon like characters are well animated with a wide range of movements. Bouncing eyeballs wink, and your green frog-like persona strolls, jumps and falls with style.

Joystick control is totally intuitive. Sometimes a forward push on the stick takes you up on a lift and sometimes through a door, but the movement always seems to come naturally. *Nebulus* gets full marks in this department. This is a game that made me yell in frustration and squirm in anger, and that's a rare treat. It seems easy - but there is always just one more obstacle to beat.

Most annoying of all is the time limit. Having used my best tactics and my finest timing to get within sight of the top of the tower my time kept running out. I tried, I really tried. I wanted to be able to describe a demolition first hand and to try the bonus screen and to find out what colour the second tower was going to be. Sorry.

Distributed by OziSoft [(02) 211 1266] *Nebulus* is available on both disk \$39.95 and cassette \$29.95. It is addictive, challenging and plain good fun. I recommend it highly even if I am still waiting to see a decent demolition. ■

Bionic Commando

by Eric Holroyd

Ten years have passed since the devastating war when the Zargon missiles of the enemy destroyed our civilisation. Our only hope for regaining our home world and rebuilding our lives lies in the hands of our elite force of BIONIC COMMANDOS.

So says the inlay on the package of this game from Capcom. It's a multi-level ladders and platform game whereby you (the aforesaid Bionic Commando) must infiltrate the enemy bases to destroy them and neutralise their doomsday missile.

To start the game BC drops by parachute. Guide him to a safe landing with the joystick and press the button when you want him to land on a ledge. Be careful you don't lose him over the edge though, or you'll lose one of the three lives you start off with.

Joystick control of BC is well-implemented and he runs and jumps around to do your bidding with great gusto. He uses his bionic arm (it looks just like a line with a grappling hook at-



tached) to overhead ledges and then climbs up it to continue the attack. He can reach quite a long way directly overhead or to either side, just position the joystick and press the firebutton to shoot his arm out. He can swing around on his bionic arm as well as pulling himself up on it. He'll crouch to avoid head high shots if you pull back on the joystick. The enemy

throws grenades and bombs though, as well as firing from their guns so it's best to keep climbing and jumping around to stay on the move.

At various points in the game extra weapons are parachuted to BC to augment the standard double shotgun he starts out with. They include: Grenade launcher, Rapid-fire gun, and a Plasma bolt-cutter. He may also receive a Turbo-charger for his bionic arm which gives extra speed. If BC catches a weapon it's displayed at the top of the screen along with how many lives are left.

The playfield is huge, with quite smooth scrolling as you move around it.

There are five levels in all, each with its own special dangers: Start off in the Dying Forest and watch out for killer bees and other dangerous flying insects. Progress to the Castle avoiding gun turrets, cannons and electric wires. Look out too for the kamikaze soldiers carrying explosives. Next comes "Infiltration" where you try to get into the underground complex via the sewer system which is infested with strange, lethal creatures. Down here too, are evil machines which catapult their drivers out to fight on if they get hit. Once you get as far as the Control Room you'll have to get to the missile with all speed, blasting the locks off some "immovable doors" first of all. Battle the soldiers and bomb-dropping helicopters as well as avoiding the "stomp machines" which do their level best to flatten you (*Ed: dreadful pun there!*).

At last you're in the Silo which is the final and most difficult level. This joint is full of surprises and I'm going to let you find out what they are for yourself. Suffice it to say that you've got to work even harder than before to stop the launch of the doomsday missile.

I enjoyed the arcade action in this game and I think it has a good deal of lasting interest. Definitely worth a look if you're a shoot-em-up freak.

Review copy from Ozisoft (02) 211-1266. RRP C\$29.95, D\$39.95. ■

Karnov

This is the quest for the lost treasure of Babylon and you'll have to defeat Ryu the evil Wizard along the way. You'll be playing the part of Karnov, the fire-breathing Russian in this fast-action/strategy combination.

This game is based on the original Data East arcade classic (*Your Sinclair* is quoted as saying it's "the most accurate conversion of an arcade hit in years") and has nine very large levels of play. The disk needs to be in the drive all the time as each successive level loads on comple-

tion of an existing level. The action scrolls in all four directions and once I'd got into it, it became quite absorbing. It never got boring as I quickly discovered that I couldn't learn all the "geography" as it's so big and there are so many routes to get to and from various places.

There's a variety of strange and bizarre monsters (have you ever been killed by a skeleton riding an ostrich?) whose main task in life is to prevent Karnov completing his quest. He's a pretty agile fellow though, and can run, swim, jump, climb and even fly, but he still needs help from you to get through the levels.

The plot itself seems familiar enough: The world is about to end and unless Karnov can defeat Ryu, regain the Treasure of Babylon, and then return it to its rightful hiding place we're all doomed.

The action is set in the village of Creamina where the Wizard Ryu had punished the locals for hiding the treasure all these centuries by dumping all these horrible creatures there to terrorise Creamina for eternity (or until Karnov can get rid of them, whichever comes sooner!)

Karnov is the only one (as usual) who has the knowledge and power to succeed and to start his quest he has to find

VIATEL ADAPTORS ONLY \$79.80 SAVE \$160 FROM COMMODORE.



Commodore is offering Viatel adaptors for only \$79.80, a saving of \$160. So if you own a Commodore 64C, 128 or 128D, transform your computer into a 2-way system, through which you can receive and act on information.

Send in this coupon now. Offer closes September 30, or until stocks last.



Commodore Business Machines SPECIAL OFFER
PO Box 404, Round Corner, NSW 2158

Please send me _____ (number required) Viatel Adaptor/s at a cost of \$79.80 each

Name: _____

Address: _____ Postcode: _____

Method of Payment (Please tick):

- Cheque Money Order Bankcard
 Mastercard Commodore Credit Card

Card No.:

--	--	--	--	--	--	--	--	--	--	--	--	--	--	--	--	--	--	--	--

Expiry Date: _____ Today's Date: _____

Card Holder's Signature: _____

Cheques and money orders should be made payable to: Commodore Business Machines Pty Ltd

John Singleton Advertising COM 0147

all the bits of the mandatory map . . .

Then there are 11 icons to be collected along the way, all of which have varying powers: Boots give double the jumping power, Ladders help to reach "out of the way" icons, Boomerangs give extra fighting power and can be used again if Karnov jumps to catch them on return, Apples also give extra firepower.

It's a good game, quite addictive and of lasting interest but not without a few gripes from me as regards presentation. The 32 page finely-printed booklet has only five pages of interest to C-64 English-speaking users. The rest are devoted

to how to load and operate it if you're using a Spectrum: models +, 128, m+2, or +3 (hence the reference to *Your Sinclair* on the packaging) or on your

Amstrad CPC 464, 664 or 6128. All this is then repeated in both French and German so that 28 of the pages are of no interest to me and my C-64. I can't see why the makers don't just print one sheet of paper for us, one for the Speccy and Amstrad owners and the same again for

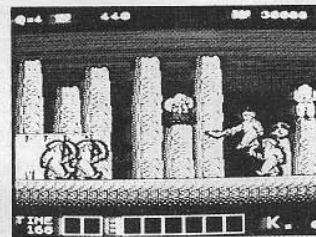
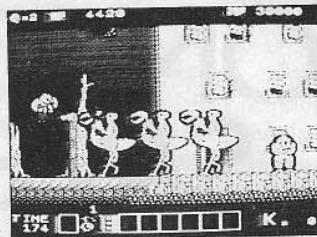

French and German users.

That apart, I liked the game and found it pleasing to play and Karnov was easy enough to control with the joystick. Definitely worth a look.

From Questor (02) 662-7944 RRP C\$29.95, D\$39.95. ■

Shoot-em-up Construction Kit by Phil Campbell



YOU NEED NEVER buy another computer game again. Why not? Because now you can program your own.

That is the promise of the new *Shoot-em-up Construction Kit*. This program, available on Commodore 64 cassette and disk, also promises to reveal all the secrets of professional games programmers and give you the power to produce "chart-topping blasters".

Four sample games are included, giving a good indication of what the package can do. The first is a classic outer-space klingon-zapper. It is well done, with little to indicate that it is the product of a construction kit. Mind you, in this case the graphics were designed by a professional.

Another sample game - *OUTLAW* - follows an entirely different theme. This time you control a cowboy, fighting off venomous snakes and arrow-firing Indians on a trek through the desert.

The demonstration games prove that the Construction Kit works. But it does not prove that I can get similar results. Can I?

The answer, of course, is "That depends . . .". That depends on how artistically I can manipulate little dots on my video screen, on how creative I am in de-

signing my game scenario, and above all, how patient I am.

Impatient, uncreative and unartistic persons need not apply.

However, the Construction Kit certainly provides you with all the ingredients for a good game. You just have to do the cooking.

The first ingredient is a "blank game" - a blob moving against a background of dots arranged on a grid. This is the canvas on which your game will take shape.

Games are built up with a set of nine Editors. Almost everything can be changed, including sprite designs, backgrounds, attack formations, player limitations and sound effects.

The Sprite Editor allows you to design and use 127 sprites in each game. A sprite, simply put, is any moving object on the screen - space ships, bullets, enemy fighters, even explosions are sprites.

Using the joystick, it is a simple matter to reshape and colour these sprites however you wish. Commands to slide, mirror and copy the sprites are provided, making the design process simple and convenient.

Your game may only need two of the 127 available sprites. If you are aiming for quality, however, you will wish to

design sprites with different angles and perspectives. This will allow your spaceship, iced donut or whatever else to twist and turn elegantly on the screen - but it will also take a lot of time and work.

Once you have designed your sprites, you must animate them. In other words, they must be told how, when, where and why to move. Firing rate, bullet speeds and point score values are also set for each object, before moving to the Sound Effects Editor to fine tune the 24 available sounds.

Everything works well, and for a while it is good fun. Beginners can experiment with the sample games to gain confidence and experience - you can change almost anything.

In fact, the *Shoot-em-up Construction Kit* is highly recommended. It is a creative program, and should give many hours of satisfaction.

But remember, it all takes time and patience. Assembling sprites and background graphics is plain hard work - and that, I suspect, is the biggest secret of professional games programmers. If you keep this in mind, you will be well pleased with the kit - and you might even design that elusive "chart-topping blaster".

Our review copy from YPA Holdings, (02) 8992277. RRP cassette \$34.95, disk 39.95. ■

CINEMAWARE
P R E S E N T S

MOE

the THREE STOOGES™

LARRY

CURLY

Can **THREE** Stooges
Save **ONE** orphanage
From **FORE**closure?!

OUR HEROES

They can save the day
by making **ASSETS**
of themselves!



THE EVIL BANKER
He took their **NEST EGG**
and told them to **BEAT IT!**



THE WIDOW AND HER 3 BEAUTIFUL DAUGHTERS
They're about to be thrown out on their **ARREARS!**

"NYUK, NYUK."

"OH, A WISE GUY!"

"RUFF! RUFF!"

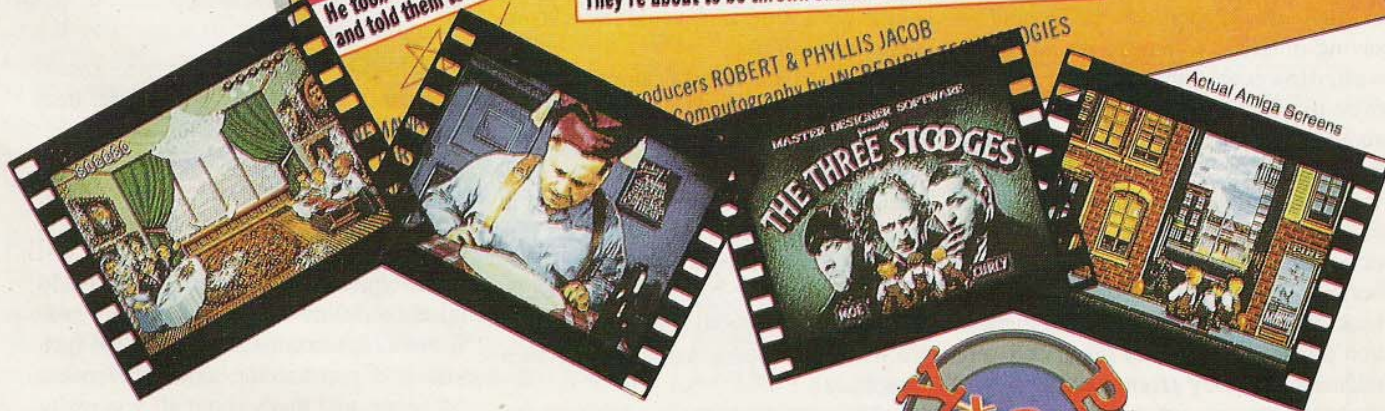

Producers **ROBERT & PHYLLIS JACOB**
Computography by **INTEGRAL TECHNOLOGIES**

Actual Amiga Screens

Available for the following formats: Amiga, Commodore 64 and IBM

YPA Holdings Pty Ltd
5-6 Gladstone Road, Castle Hill, NSW 2154
Phone: (02) 899 2277, Fax: (02) 899 2348



128 Corner — GEOS

by Harry Waterworth

As a user of the Geos range of products for the past year and a half, the article in the July edition confirmed what a lot of 128 owners already know, and that is that the 128 is "The Boss" of the eight bit computers. I had been using the Geos 64 programs until about two months ago when my copy of Geos 128 arrived, together with the dedicated 128 versions of *geoWrite Workshop*, *geoCalc* and *geoFile*.

Firstly, to all you 128 owners with existing Geos 64 products, there's the old good news/bad news story. The good news is that Berkeley's in California offer an up-date service at much reduced prices. The bad news is that their customer service is poor to say the least. My up-grade copies took THREE months to arrive after payment had been sent, and it also took numerous letters of complaint to finally get results.

Cost details (as at March '88) are as follows:-

Geos 128 Upgrade (from Geos 64)	US\$24.50
geoWrite Workshop 128 (From Writers Workshop 64)	US\$20.50
Postage	US\$ 9.00
TOTAL	US\$54.00

This cost me \$75 in Aussie dollars back in March, and when you think that both of these programs sell for \$129 each in Australia, ie total cost \$258; that's a saving of \$183, so maybe it's worth the wait. However, three months is a bit over the top, and Berkeley Softworks should look closely at this side of their operation.

Now, to quickly elaborate on a couple of items in the July article. As mentioned, there are a number of disk swaps between the original boot disk and the back-up systems disk during the installation process. The reason for these swaps relates to Berkeley's form of copy protection. What is happening is this:-

The System disk is writing a serial number on to the Back-up disk, and it is these disks that are then used for the future installation and running of other Geos programs, ie *geoCalc 128*, *geoFile 128*, *geoPublish 128* etc. When you purchase these additional programs and install them as per instructions, they will then also be imprinted with the same serial number. This means that any newly installed program will only ever work with your own boot disk, and not with anybody else's.

The other item mentioned in the same article concerns the margins in *geoWrite*. With *Geos 128*, you are supplied with *geoWrite* version 1.3 on the applications disk. With this version, the margin settings on screen appear as 1.2" left margin and 7.2" right margin. In fact, if you use these settings, the printout (using a Citizen 120D printer) will come to the edge of both sides of your paper when the printout is effected.

All this means is a bit of experimentation with your own printer to see what the final outcome will be, and you then set your margins accordingly. However, I would strongly advise that any reader who has purchased *Geos 128* should also go one step further and buy *geoWrite Workshop 128*, for without this additional program, the word processing side of the Geos programs would leave something to be desired.

Some of the extra features you get with the *geoWrite 128* package are as follows:- headers and footers; single, one and a half and double line spacing; decimal tab stops; individual formatting of paragraphs; the ability to select an ENTIRE page of text to change fonts, re-format etc; capacity to use superscript and subscript; a word search and replace facility; individual formatting of paragraphs.

There are many more additional fea-

tures, but the best one is the full 80 column screen display, which means no more side to side scrolling. In fact, *geoWrite 128* requires an 80 column monitor, as it cannot be used at all in 40 column mode. Accordingly, if you don't have a monitor with 40/80 column capacity, then stick with the basic *Geos 128* package, as the *Writer's Workshop* will be useless to you.

1351 mouse and 1750 Ram Expander

Now, to deal with the 1351 Mouse and the 1750 Ram Expander. I have been using the 1351 Mouse for the past nine months or so, and I have now had the Ram Expander for the past three months. All I can say is that *Geos 128*, the mouse and the 1750 Ram Expander are made to go together.

A word of warning; if you don't wish to buy a 1750 expander, then don't even look at one in action, for the difference has to be seen to be believed. Once you have seen one and tried it, you will certainly want to buy one. The difference is astounding, to say the least. With an additional 512K of Ram available, this takes your 128 computer up to 640K, more Ram even than that "other" computer, the wellknown Amiga 500, has in its native form.

Wordprocessing

In this month's article we will deal with *Geos 128* and *geoWrite 128*, the word processing side of the Geos family. After installing *geoWrite*, the next thing to do (after making a back-up copy) is to create a work disk.

A typical work disk might be made up of the following files:- Desktop; *geoWrite 128*; four or five fonts of the type you find you use the most; Preference Manager, and that's about all you really

need. This will leave plenty of space on the disk for the documents you wish to create.

It is not necessary to have the printer driver or the input driver files on your work disk when using *Geos 128*. As long as these files are correctly placed on your boot disk, ie the first of the printer files on the boot disk must be the one for your printer and the first input driver (either mouse or joystick) must also match the device you will be using, then these files will be the automatic default files every time you use Geos.

You can also add other files you may find useful, such as a calculator; an alarm clock; a note pad, plus a few more, and these are all fully described in the manuals. Having tailored your work disk, you are now up and running. If you have the Ram Expander, your next step is to copy the work disk into the Ram disk, (which only takes about forty seconds or so) then open the Ram disk and you're ready to start work on your file.

When you open up a new file and start typing, the default font is BSW, (short for Berkeley Soft Works). However, you can easily change to one of the other fonts by simply using the mouse to click on the font menu, and then selecting one of the other six fonts provided.

For ease of on-screen reading, I generally type in either University or California font in 10 point size, and then select boldface from the style menu. When the document is completed, if you wish the printout to be in a different font, the procedure is easy. You simply click on the options menu on the top of the screen. A drop-down sub-menu then appears from which you select the last option "select page", and the screen changes to reverse video. You then select the desired font, size and style and when that is done, your changes are immediately effected. All that is left to do is to click the cursor anywhere on the page, and the screen changes from the reverse video mode back to normal, and you then see what the final product will look like in print.

Mouse control

The beauty of the Geos system lies in the fact that there are no keyboard controls or special programming techniques to daunt the novice user. Everything is done with the mouse in a similar fashion to some of the Amiga programs. You simply point at the appropriate menu, and with one or two quick clicks, your fonts and styles are changed, paragraph markers are set, margins are expanded or reduced and the finished document appears on screen ready for printing.

Geos is a WYSIWYG product (what you see is what you get) so if you don't like any of your changes in fonts, styles etc, then it is a simple matter to click away with the mouse, and in no time, you will come up with the right combination to suit the task at hand.

Other facilities that are available include a cut and paste facility; page numbering and dating; left, right, centre or full

line justification; the capacity to insert graphics from *geoPaint* into your document and many others too numerous to mention. Now that this dedicated 128 version of Geos (coupled with *geoWrite 128*) is available, it should find a place in the homes of all 128 owners, particularly with the ready availability of the ram expander.

With the new, powerful software being released to support this tool, any 128 owners who were perhaps looking to update to a more powerful computer will probably now opt to stay with their existing set-up (and save themselves a fortune to boot).

Next month, we will take a look at *geoPaint* and provide some hints and tips to get better looking graphics. In the coming months we will also look at *geoCalc*, *geoFile* and *geoPublish*, and also other non-Geos programs that make use of the additional power of the ram expander. ■

Note - GEOS 128

We have been informed that some faulty program disk were put out by Berkeley Software. They apologise for this problem, caused by a bad batch in manufacture. If you have trouble with your program refer to Computermate (02) 457 8118.

Commodore computer PCB exchange service

- ◆ Same day certified mail despatch ◆
- ◆ Three months warranty cover ◆
- ◆ Re-assembly instructions included ◆

Commodore Vic 20, C16, Plus 4 **\$49**

Commodore C64, 64C **\$89**

- Simply remove your faulty board from its casing
- Your board must be complete and in serviceable condition.
- Forward your securely packed board together with your remittance to:

P PTY. LTD.
Parcom

Whites Hill Shopping Village
Samuel Street
Camp Hill, QLD, 4152
Phone (07) 395 2211

BANKCARD/MASTERCARD/CHEQUE/POSTAL ORDER

NAME.....
ADDRESS.....
PHONE.....PC.....
PAY BY CHEQUE..... B/C..... M/C..... Postal Order.....
CARD NO.....
EXPIRY DATE
SIGNATURE.....DATE.....

Superbase

Recovering from errors

by Peter Gallen

THIS MONTH we'll start off with some news which also answers some of the questions I've received about the availability of *Superbase: the Book* - Dr Hunt's valuable book on using Superbase. By the time this article is published, Ozisoft should have taken over national distribution of Precision Software products, including *Superbase* and *Superscript*. This may not lead to an immediate supply of the book but you will now have a contact point for service and supplies.

I've also heard that the programmer's version of *Superbase* for the Amiga has now been launched locally, but the long promised Utility Program for the C128 is still not available!

This article will concentrate on the inevitable problems associated with recovering from errors.

First, some general comments and suggestions which are applicable to all C64/128 files, including *Superbase* ones.

SPLAT FILES: These are sequential files that appear in the directory marked with a '*', and are usually caused by a failure to close the file when writing it to disk. This may be due to a system failure or disk full error. Most Commodore texts state that this is an unrecoverable error and the disk should be immediately 'validated'. But what about all that valuable data you spent lots of time collecting and entering? Well, all is not as bad as at first appears. I think the basis for the following recovery program was first published in *Transactor* magazine - I've been using a version of it on an old 8032/8050 combination at work quite successfully for some years. It is based

on a little documented command - 'm', which is one of the three commands for handling sequential files. These are 's,r' = seq.read, 's,w' = seq.write, and 's,m' = seq.mend. (I think that's what it's short for!). The program listed in FIG 1. illustrates this technique and I won't explain it further except to point out that it renames the temp file to the original name at the end. Don't forget to validate the disk AFTER running this program to ensure the directory has been updated.

USE OF VALIDATE: Many manuals will tell you that validating a disk will destroy relative and random access files. Well, that may be, however the good folk at Precision somehow overcame this problem and I can assure you that you can validate your Superbase disks with no problems. This is a particularly good idea after a system crash or lockup and certainly will not cause any harm if done regularly or when you suspect that the directory listing of 'blocks free' is incorrect. Don't forget that validating a disk will remove splat files irretrievably.

Figure 1.

```

10 rem recover a splat file
20 input"enter corrupted file name";f1$
30 input"enter temporary file name";f2$
40 open 1,8,9,"0:"+f1$+","s,m": rem note use of m
50 open 2,8,8,"@0:"+f2$+","s,w"
60 get#1,a$
70 if a$="" then a$=chr$(0)
80 if st=64 then 1000
90 printa$;print#2,a$;goto60
1000 close1:close2
1010print:print" verifying disk...."
1020 open1,8,15:print#1, "v0"
1030 print:print"deleting temporary file....."
1040 print#1, "r0:"+f1$+"="+f2$:close1

```

Errors

Errors in *Superbase* are usually due to 'disk full' or 'data/index mismatch'. The *Superbase* manual offers no help in recovering from such errors except to try 'export' and even Dr. Hunt can be terse - suggesting that to recover from such an error you write a program to read forward to the error and one to read backwards from the end. In this way you can recover most if not all your data. You usually will lose at least two records but this is much preferable to starting over.

Unfortunately, no demo programs are given, so to help out I've written two such programs, Fig 2 and Fig 3. These may not be elegant, but they should be easy enough to follow and customise.

Of course the best method to use to recover a damaged database is the Utility Program provided on the *Superbase V2* disk (C64 only). Until the C128 version is available I suggest that it could be used to recover C128 files as long as they don't use more than one side of a disk. Experimentation before you get into trouble is advised and be sure you are using a copy of your data disks!

Once you have recovered your data and re-entered any lost data, you may be left with unwanted files. This may happen at any time, so I've included a program to delete records and file definition from *Superbase* and then to delete the file from the directory. This may be adapted to suit any single one of these tasks. Refer to Fig 4.

I've been asked if you can create 'list' files on a second disk drive. This would be a great asset in saving valuable disk space. However I've not been successful in this - if anyone out there can help it would be great to hear from

you! Unfortunately due to business commitments this month's article is shorter than normal, although I believe it covers important issues.

Don't forget to drop a list of suggestions or problems to ACR or direct to me at PO Box 115, Rozelle, NSW 2039.

BBSing in Western Australia

by Nathan Cochrane

Figure 2.

```
10 rem move forward to recover data
20 file "australia"
30 select f
40 a$=[item1]:b$=[item2]:c$=[item3]
50 file "restore"
60 clear
70 [data1]=a$:[data2]=b$:[data3]=c$
80 store the record
90 file "australia"
100 select n
110 goto40
```

Figure 3.

```
10 rem restore backwards
20 file "australian"
30 select l
40 a$=[item1]:b$=[item2]:c$=[item3]
50 file "restore"
60 clear
70 [data1]=a$:[data2]=b$:[data3]=c$
80 store the record
90 file "australia"
100 select p
110 goto40
130 rem **** if disk space is critical
use this line 100 to automatically
140 rem **** delete the record after it
has been transferred
150 rem 100 select c:delete: select p
```

Figure 4.

```
10 rem delete file totally from disk
20 file "filename"
30 select f
40 select d:eof 60
50 goto40
60 select d: rem deletes file from su-
perbase
70 maintain o"s0.filename": rem de-
letes file from directory
80 menu
```

COMPUTER TO COMPUTER telecommunications has taken off in a big way in the past few years. With prices of hardware and their associated software packages falling in quantum bounds, not only have more people been able to take advantage of electronic message services (commonly known as Bulletin Boards or BBS), but more people have been able to outlay the large sums of money required to set them up in the first place.

Western Australia, isolated from the rest of the world by distance, desert and sea, is the ideal stomping ground for this new breed of Phone Phreaks, BBS Bof-fins and other assorted creatures of the phone lines. From on-line games to the infernal Amiga/Archimedes/Atari ST debate, these boards have enough to keep everyone entertained and itching for more.

Many SysOps in the past few months have recognized the fact that a huge downloads section need not necessarily be the best way to increase your user base or the quality of your information. To this end an increasing number of local boards are switching to specific interest areas in an effort to attract the general user (often with hobbies outside computing) and the serious hacker/programmer, rather than just the pirate back to their systems.

One of these specialty boards is **Kardinya Turbo**. Run off a PC, the SysOps might just have found an answer to the QBBS/Binkley vs Opus debate. In an effort to customize their board to their own specifications, the SysOps have written their own software, and the results are very pleasing to say the least. All baud rates are supported up to 2400/2400 and as far as I know there are no bugs at all in the system. Oddly enough

the board's specialty is programming, mainly in 'C', Modula 2 and Assembler.

Another specialty board goes by the handle **Codiac Republic**. Codiac has gone in the other direction and provides a role playing service for its members. For all aspiring DM's this board is an absolute must.

Lightning is perhaps one of the

Horseracing, Trots or greyhounds Winners galore

With our new race tipster a unique powerful easy to operate selection system you respond to a number of questions and the **Race Tipster** will find the horse with the most chances of winning. Points for all runners are shown on screen.

Disk or tape \$39 post included.

The Race Selections

Analysers— A program which will allow you to bet up to 3 runners in a race. (Similar to the popular Dutch book) The computer will show you how much to bet on each runner (\$1 units) and display all investments and dividends.

Disk or tape \$39 post included.

The two power programs \$59

Our book **Treasure Chest** for C64/128 is still available. It is a compact and handy guide full of unusual programs, sub routines and programming hints. Learn to use **POKE PEEKS USR SYS** and other tricks by the book and get free **Lotto Analyser**, **Typing Tutor** or **Maths Tutor** on disk or tape.

Price of book \$23 post included.

For details of book contents or racing programs send your stamped and self addressed envelope (large) without obligation. Please send cheques or money orders to:

Apex Computer Products

35 Spruce Street
Loganlea, Qld, 4131
(07) 299 6669

best known local boards. Sponsored by a WA retail outlet, it is vital to the continued existence of FidoNet in this state. SysOp'd by Simon Blears, the board also boasts a Trailblazer modem and through its national and local Echoing facility allows users to keep abreast of current events. Being so far away from the central population areas in the Eastern States, Perth relies heavily on Fido for this vital conferencing information.

A big talking point on WA Echo-mail at the moment is the subject of "users' rights". A few disgruntled members of the local community are complaining that users are totally at the mercy and whims of the SysOps. They go on to claim that their freedom of speech is thus being curtailed and such a situation is therefore undemocratic.

The feeling, however, of the overwhelming majority of both users and SysOps is that this is absolute nonsense. Bulletin Boards are often run at substantial money losses by their dedicated owners and provided as a service - not a right - to those who choose to access the information these boards provide. SysOp privileges belong firmly in the hands of those that spend so much time and effort building their systems up, certainly not to the general community. Imagine what the results of a clumsy novice could be to a system if he had such 'rights'.

It is the general feeling that the users' rights line of thought is either foolish, grossly irresponsible or utterly naive.

A big part of any service a board offers is its on-line games. Two of the most popular in WA are *Star Web* and *Trade Wars*.

Trade Wars is an interplanetary trading game. Players journey from star system to star system buying and selling commodities a la *Elite* in the hopes of making a fast credit. The game has a reasonably large following and all decisions entered are carried out in real time.

Another more complex, though in essence similar version of the game is *Star Web*. Same as before, players can interact with each other, buying and selling from planet to planet, but all moves are calcu-

lated for their time and point value and then store, to be carried out at the end of the day. This ensures that greedy gamers don't necessarily have the edge by hogging the game's time. Sadly neither of these great games is multi line.

Another on-line service that is also very popular is *The Neverending Story*. From the seed of a script, users are encouraged to provide their own plot to add to the whole. The results are in turn comical, sad, frightening or just plain nonsensical but never ever boring.

One of the new boards to have gone on-line in recent months, and where you will find *The Neverending Story*, is called **Terminal** (no jokes, please!). Terminal is also a member of the Fido community and as such has access to all the conferences and so on. Terminal runs QBBS/Binkley with a multi tasking manager assuring that the board is always on-line during housekeeping chores. Terminal plans on switching over its software and going multi-line sometime in the near future.

Terminal boasts an extensive PD software downloads area for most popular machines as well as the latest Terminal and Echo messages. The board has instituted an Abuse Corner in an effort to keep such comments off the other areas by providing an outlet for rivalries. This ensures that the integrity of the board is sustained so that people who do not wish to read such comments do not have to have it inflicted unwittingly on them.

One of the more unusual features of the board is its ongoing competition - The Running Man. People are divided into teams and carry out a real life (well, nearly anyway) game of hide and seek. Provided with sketchy details, the team target another team for a mock assassination. No Violence is Permitted. Strict rules of conduct ensure that situations do not develop in which someone could be hurt either through action or inaction. People found breaching these conditions will be thrown off the board and prohibited from playing again. Response, especially from gamers, has been very encouraging and plans to have the game off

the ground shortly are under way.

With all this diversity and activity it is no wonder that the computer industry (especially Commodore computers) is doing so well in WA. In the past year many new boards have opened their gateways to new users and old hacks. This is doubly encouraging as whilst they share many common traits, there is a greater choice and diversity in the local scene than there was even as short a time as eighteen months ago.

While there are the chronic callers who will dial anything with a prefix, many of these boards boast a large and fiercely loyal user base. This rise in users (many of them officially registered with the SysOps) can be attributed in the main to more powerful computers combined with faster, cheaper and more reliable modems with increasingly more features. It also stems from a growing awareness that there is an exciting, inexpensive and informative world just a phone call away.

The future of bulletin boards in WA certainly seems bright. From plans to open up new Amiga developers boards (not available to the general public), subsidiary mail order services with special offers for members and remote programming courses - to name a few - there certainly is no lack of interest of vitality in the West as far as telecommunications and bulletin boards are concerned.

One last word. If WA users are to get the most out of their boards and Fido, there must be a continuing commitment to quality. A BBS stands or falls on the value of its information, and that means contributions across all sectors of the BBS community must be of a high standard and on an ongoing basis. This will help to ensure that the boards are kept up to the current high level of excellence users have come to expect and enjoy.

And that goes for the humble BBS everywhere.

Kardinya Turbo - (09) 331 1695, Cordiac Republic - (09) 481 2139, Lightning - (09) 275 8225, Terminal - (09) 389 8048. ■

Australian Commodore Review SUITE 64

Disk magazine No. 11

C
O
N
T
E
N
T
S

Education

- ★ Equation manipulation
- ★ Linear equations
- ★ Probability

Utilities

- ★ 80 Characters
- ★ Graphic converter
- ★ Batch line number deleter
- ★ Function key definition
- ★ System call locator

DOS Utilities

- ★ Fix directory
- ★ Text search
- ★ Disk tidy
- ★ Drive aligner
- ★ Disk doctor

Entertainment

- ★ Hi-res jigsaw puzzle

Demos

- ★ Hi res optical illusion graphic
- ★ Animated boxes

Geos printer drivers

- ★ Bluechip M120, C.Itoh 8510, C.Itoh 8510a, Commodore Compatible, Epson FX-80, Epson MX-80, Epson JX-80, Gemini 10X, HP Laserjet, IBM 5152+, Imagewriter, Imagewriter II, MPS-801, MPS-1000, OKI 120, Olivetti PR2300, OKI ML -92/93, Okimate 10, Okimate 20, MPS 1200, Riteman C+, Scribe, Star NB-15, Star NL-10, Star NX-10, Star NX-10c, Star SG-10/15, 1526.



**DISK MAGAZINE
NO 11**
Double sided disk

 Please send me issue 11 of Suite 64 @ \$12.95
 Please send me issues 1-6 @ special price of \$49.95
 (For more information on back issues
 see our advertisement in this issue.)

Detach and send to Gareth Powell Publishing
 21 Darley Road Randwick, 2031
 Or Phone (02) 398 5111 with Bankcard Order

Name:..... Address:.....
 Postcode:.....

Cheque Bankcard No.:..... Expiry Date:.....

Signature:.....

Please add \$2.00 for postage and packaging and allow two weeks for delivery.

(NOTE: these disks are not for Amigas)

C-128 Pokes

POKE	EFFECT
24,1	MAKE LISTING "GARBAGE"
24,27	DISABLE THE ABOVE
24,37	DISABLE LINE NUMBERS DURING "LIST"
24,27	ENABLE LINE NUMBERS DURING "LIST"
24,53	CAUSE SYSTEM LOCK-UP
24,27	DISABLE THE ABOVE
208,0	CLEAR KEYBOARD BUFFER BEFORE INPUT
241,X (X=1-16)	CHANGE CHARACTER COLOR
775,171	CRASH ON "LIST" COMMAND
775,81	DISABLE THE ABOVE
775,139	DISABLE LIST
775,81	ENABLE LIST
775,200	ENABLES LINE NUMBERS ONLY ON "LIST"
775,81	DISABLES THE ABOVE
792,125	DISABLE RESTORE
792,64	ENABLE RESTORE
808,98	DISABLE RUN/STOP & RESTORE
808,100	DISABLE RUN/STOP
808,110	ENABLE RUN/STOP
808,222	DISABLE RUN/STOP & RESTORE
808,110	ENABLE RUN/STOP & RESTORE
808,233	DISABLE RUN/STOP
808,110	ENABLE RUN/STOP
816,0	DISABLE LOAD
816,108	ENABLE LOAD
818,180	DISABLE SAVE
818,78	ENABLE SAVE
819,245	DISABLE THE ABOVE
2592,0	DISABLE KEYBOARD
2592,10	ENABLE KEYBOARD
2594,64	DISABLE REPEATING KEYS
2594,255	ENABLE REPEATING KEYS
2594,0	ENABLE SPACE/DELETE/CURSOR KEYS REPEAT
53265,11	SCREEN BLANKING
53265,27	DISABLE THE ABOVE
53296,1	ENABLE FAST MODE (2 MHZ)
53296,252	ENABLE SLOW MODE (1 MHZ)
53220	JOYSTICK PORT 1
56231	JOYSTICK PORT 2
53280,X (X=1-16)	SET BORDER COLOR
53281,X (X=1-16)	SET SCREEN COLOR

C-128 SYS Calls

SYS	EFFECT
3072	"AHOY" BUG REPELLENT "ON"
4864	"COMMODORE" MAGAZINE ENTRY PROGRAM "ON"
5120	"RUN" PERFECT TYPIST "ON"
5150	"RUN" PERFECT TYPIST "OFF"
32800/123/45/6	DISPLAYS AUTHORS NAMES
65341	COLD START
65357	GO TO 64 MODE
65375	TOGGLE 40/80 COLUMNS

To reset the computer to C-64 mode from within a C-128 program include a line as follows:-

(line no.)bank1:poke 65528,77:poke 65529,255:bank15

The above compilation has been gleaned from many sources and we suggest that you experiment with the various commands to find the ones best suited to your purposes. ■

Commodore and Amiga Annuals 1988

The most valuable publications you could ever hope to add to your magazine collection.

In a special Annual edition, one each for the Commodore and Amiga Computers, these provide the most exhaustive guide to home computing in Australia. Each Annual contains a comprehensive glossary of terminology divided into special subject categories.

Subjects such as communications, graphics, music, small business and entertainment are given coverage.

For beginners there's tutorials, and for the expert articles on subjects you've only heard about - Listings of software packages and comparisons of leading brands.

Don't Miss Them!
Great value at \$5.95
Available NOW direct from us

To: Gareth Powell Publications, 21 Darley Road,
Randwick, 2031. Phone (02) 398 5111

Name.....Address.....
.....Postcode.....
Cheque.....Bankcard.....No.....Exp.....
Please send meCopies of Amiga Annual 1988
Please send meCopies of Commodore Annual 1988
at a cost of \$5.95 each plus \$1.00 P. & P.

Don't miss out on these great bargains!

Australian Commodore Review Disk Mags Nos 1 to 10

<p>Disk Magazine One \$10</p> <p>Forest Raiders - Full machine code shoot 'em up Machine code paint, border, input and flash routines Nice Lister - for readable listings on non-Commodore printers. Recover II - for recovering deleted files, and a catalog program - for getting a disk directory without losing your program <i>And More...</i></p>	<p>Disk Magazine Two \$10</p> <p>Programs demonstrating 3D graphic plots A terminal program called Teleport A tutorial on bits and bytes Character editor - for designing your own custom alphabets and graphics & A full demonstration of Electronic Card File <i>And More...</i></p>												
<p>Disk Magazine Three \$10</p> <p>Programs: Hangman, Labyrinth, Calendar, Finance, Typing Practice, Roadblock, Bird Invaders Feature: Constructabrix - education and graphic construction program for younger users <i>And More...</i></p>	<p>Disk Magazine Four \$10</p> <p style="text-align: center;"><i>Featuring:</i> Graphic Workshop _ a complete design system for sprites, graphics, and character sets - with tutorials Also: Typing Tutor - a complete typing program Works on errors, counts your speed <i>And More...</i></p>												
<p>Disk Magazine Five \$10</p> <p>Utilities for using Newsroom on an MPS 802 plus printing disk cover with directories, writing signs, printing Doodle and Printshop pictures and more all on the MPS 802! A demonstration of games in the future <i>And More...</i></p>	<p>Disk Magazine Six : \$12</p> <table border="0" style="width: 100%;"> <tr> <td>Games: Bert the Bug</td> <td>Home Inventory</td> </tr> <tr> <td>Hangman</td> <td>Graphics: Light Fantastic</td> </tr> <tr> <td>Demos: Amiga Pharoah</td> <td>Utilities:</td> </tr> <tr> <td>Space Harrier, Max Headroom</td> <td>1571 Utility</td> </tr> <tr> <td>The Pacer, Sade</td> <td>DIR@828</td> </tr> <tr> <td></td> <td>Disk Filer <i>And More...</i></td> </tr> </table>	Games: Bert the Bug	Home Inventory	Hangman	Graphics: Light Fantastic	Demos: Amiga Pharoah	Utilities:	Space Harrier, Max Headroom	1571 Utility	The Pacer, Sade	DIR@828		Disk Filer <i>And More...</i>
Games: Bert the Bug	Home Inventory												
Hangman	Graphics: Light Fantastic												
Demos: Amiga Pharoah	Utilities:												
Space Harrier, Max Headroom	1571 Utility												
The Pacer, Sade	DIR@828												
	Disk Filer <i>And More...</i>												
<p>Disk Magazine Seven \$12</p> <p>Utilities: Anti-Isepic, Sledgehammer, Fast Format, Renum- ber, PS/PM/NR, PS Printer, Graphics Editor. Other: Joystick Tester, Irish Jokes, Convertor, Ultimate Writer, Home Finance, Oscilloscope, Dice Roller, Chord Maker, Dark Forest, Don Martin, Funny, Music Classics. Demos: Karate Kid II, Thrust Concert, 3D Demo, and more. For 128: Bootmaker 128/64 Utility, Convert Basics utility.</p>	<p>Disk Magazine Eight \$12</p> <p>Utilities Track and Sector, Function Keys, Unscratched, Relocatable directory, Tape Rename Home/Business Calendars, Chequewriter, Screen clock Graphics ESCOS version 2.99, Newsroom Camera, Clear Screen, Future Writer , Demos, Enterprise II, Eddie Murphy Games A super special for issue 8.</p>												
<p>Disk Magazine Nine \$12</p> <table border="0" style="width: 100%;"> <tr> <td>C64</td> <td>C128</td> </tr> <tr> <td>14 graphics and music demonstrations from Compunet Little Invoicer Sprite Clock Sprites in the Border Also various games, utilities and graphics programs.</td> <td>128 Disk Filer 128 Block Reader Also three music programs</td> </tr> </table>	C64	C128	14 graphics and music demonstrations from Compunet Little Invoicer Sprite Clock Sprites in the Border Also various games, utilities and graphics programs.	128 Disk Filer 128 Block Reader Also three music programs	<p>Disk Magazine Ten \$12.95</p> <p>Features our new ADOS point and click menu system, using simple pop-up windows, and icons to select programs. Cup challenge - sailing simulation Amiga memories Escos with Music Define your function keys Othello Look-alike Compiled Appointment Manager (March ACR)</p>								
C64	C128												
14 graphics and music demonstrations from Compunet Little Invoicer Sprite Clock Sprites in the Border Also various games, utilities and graphics programs.	128 Disk Filer 128 Block Reader Also three music programs												

<p>Order Form</p> <p>Name.....</p> <p>Address.....</p> <p>.....Postcode.....</p> <p><input type="checkbox"/> Cheque <input type="checkbox"/> Bankcard <input type="checkbox"/> MoneyOrder</p> <p>No:.....</p> <p>Expiry Date.....</p> <p>Signature.....</p>	<p>Please send me:</p> <p>_____ copies Disk Magazine No 1 @ \$10</p> <p>_____ copies Disk Magazine No 2 @ \$10</p> <p>_____ copies Disk Magazine No 3 @ \$10</p> <p>_____ copies Disk Magazine No 4 @ \$10</p> <p>_____ copies Disk Magazine No 5 @ \$10</p> <p>_____ copies Disk Magazine No 6 @ \$12</p> <p>_____ copies Disk Magazine No 7 @ \$12</p> <p>_____ copies Disk Magazine No 8 @ \$12</p> <p>_____ copies Disk Magazine No 9 @ \$12</p> <p>_____ copies Disk Magazine No 10 @ \$12.95</p> <p>PLUS \$2.00 P+P TOTAL _____</p>	<p>Post to:</p> <p>Australian Commodore Review 21 Darley Road Randwick, NSW 2031 OR Use your Bankcard and phone us to order on: (02) 398 5111</p> <p style="text-align: center;">Please allow two weeks for postage and delivery</p>
<p>Postage and packing \$2.00</p>		

Panes Basic Loader

IN OUR JULY magazine we ran a programming article on an amazing creation by Andrew Baines which allows you to produce windows within your Basic program. However, due to space limitations we were only able to include the assembly language source code (a weird tongue spoken by machine language programmers). For all the rest of us who prefer to use Basic here's a version that includes the necessary program in DATA statements ready for you to type in and run. Refer back to the article in July for details of how to use it. If you don't want to type it in a working version is on Disk Magazine No 12.

```

790 if asc (c$)=1 then print#1, spc(6)*p
art match"
800 if asc (c$)=2 then print#1, spc(6)*[
BLK]text found[WHT]"
810 z=1: rem we got at least 1 match
818 rem sectors not read in sequential
order but 0,10,1,11,2,12 etc
820 print#15,"m-e" chr$(38) chr$(3): rem
continue scanning
830 goto 660: rem loop back for more
840 close 15
850 if z=0 then print "[DOWN][DOWN][RGHT
][RGHT][RGHT][RGHT]no matches foun
d on this disk"
860 print#1
870 close 1
880 print "[DOWN][DOWN][RGHT][RGHT]done"
: goto2000
890 rem **** read error channel ****
900 input#15,er,er$
910 return
920 rem **** disk code ****
930 data 169,0,133,15,133,70,169,1,133,1
4,32,75
940 data 242,133,67,32,142,3,169,128,133
,4,165,4
950 data 201,128,240,250,32,132,3,32,82,
3,133,16
960 data 208,40,24,165,15,105,10,133,15,
197,67,144
970 data 222,230,70,165,70,133,15,201,10
,144,212,169
980 data 0,133,15,133,70,165,14,201,35,2
40,84,230
990 data 14,165,14,76,8,3,32,142,3,96,16
2,1
1000 data 232,240,35,189,0,7,205,1,4,240
,2,208
1010 data 243,160,1,232,240,17,189,0,7,2
17,1,4
1020 data 208,230,200,204,0,4,208,239,16
9,2,96,169
1030 data 1,96,169,0,96,173,0,28,41,8,20
8,10
1040 data 173,0,28,9,8,141,0,28,208,12,1
65,15
1050 data 240,8,173,0,28,41,247,141,0,28
,96,76
1060 data 5,208
1070 rem **** convert hex to dec if nec
essary ****
1080 if left$(h$,1)<>"$" then h=val (h$)
: goto 1150
1090 h$=right$(h$, len (h$)-1)
1100 h=0
1110 for i=1 to len (h$)
1120 a=asc ( mid$(h$,i,1))-48
1130 h=h*16+a+(a>9)*7
1140 next
1150 return
2000 input"[DOWN][DOWN]again (y/n) y[LE
FT][LEFT][LEFT]";yn$
2010 ifyn$="y"thenrun
2020 end

ready.

```

```

10 i=50500
20 read a:if a=256 then 40
25 ck=ck+a
30 poke i,a:i=i+1:goto 20
40 ifck<>95979thenprint"error in data st
atements":end
50 open3,8,1,"@:pane,p,w"
60 poke157,128:poke251,68:poke252,197
70 poke780,251:poke781,241:poke782,199
80 sys65496:close3
90 rem poke 50525 for top left corner
100 rem poke 50526 for top right corner
110 rem poke 50527 for bottom left corne
r
120 rem poke 50528 for bottom right corn
er
130 rem poke 50529 for horizontal
140 rem poke 50530 for vertical
199 z$=chr$(0)
200 sys50500,0,0,11,1,1,0,1,"try this on
"+z$+"for size"+z$
210 sys50500,10,10,11,13,2,1,1,"a"+z$+"b
"+z$+"c"+z$+"d"+z$
215 a=peek(780):a=a+64:a$=chr$(a)
220 sys50500,0,20,11,1,1,0,1,"you chose
"+a+z$
500 end
50500 data 76,135,199,76,99,197,0,0
50508 data 0,0,0,0,0,0,0,0
50516 data 0,0,0,0,0,0,0,0
50524 data 200,176,174,173,189,192,221,1
41
50532 data 83,197,142,78,197,140,79,197
50540 data 160,0,152,162,0,24,46,83
50548 data 197,144,1,232,138,153,80,197
50556 data 200,192,2,208,238,24,78,83
50564 data 197,78,83,197,173,80,197,208
50572 data 3,76,216,197,173,91,197,133
50580 data 253,173,92,197,133,254,32,165
50588 data 197,169,216,32,168,197,76,216
50596 data 197,173,136,2,133,252,160,0
50604 data 132,251,24,105,4,141,82,197
50612 data 177,251,145,253,200,208,249,2
30
50620 data 254,230,252,166,252,236,82,19
7
50628 data 208,238,96,142,82,197,174,75
50636 data 197,172,74,197,24,32,240,255
50644 data 174,82,197,96,173,75,197,141
50652 data 89,197,173,74,197,141,88,197
50660 data 32,199,197,173,83,197,141,134

```

```

50668 data 2,173,93,197,32,210,255,56
50676 data 173,76,197,237,74,197,168,140
50684 data 86,197,173,97,197,32,210,255
50692 data 136,208,247,173,94,197,32,210
50700 data 255,56,173,77,197,237,75,197
50708 data 170,142,85,197,141,84,197,173
50716 data 78,197,133,251,173,79,197,133
50724 data 252,238,75,197,32,199,197,173
50732 data 98,197,32,210,255,173,87,197
50740 data 141,134,2,160,0,177,251,240
50748 data 14,32,210,255,230,251,164,251
50756 data 208,241,230,252,24,144,236,16
6
50764 data 211,236,76,197,240,14,176,17
50772 data 169,32,32,210,255,166,211,236
50780 data 76,197,208,244,169,32,32,210
50788 data 255,230,251,164,251,208,2,230
50796 data 252,173,134,2,141,87,197,173
50804 data 83,197,141,134,2,173,98,197
50812 data 32,210,255,206,85,197,174,85
50820 data 197,16,158,238,75,197,32,199
50828 data 197,173,95,197,32,210,255,172
50836 data 86,197,173,97,197,32,210,255
50844 data 136,208,247,173,96,197,32,210
50852 data 255,76,181,198,173,88,197,141
50860 data 74,197,173,89,197,141,75,197
50868 data 96,173,81,197,208,12,173,0
50876 data 220,41,16,201,0,208,247,76
50884 data 56,199,238,88,197,238,89,197
50892 data 32,168,198,206,89,197,238,77
50900 data 197,238,77,197,32,116,199,32
50908 data 5,199,173,0,220,41,1,201
50916 data 0,208,3,76,16,199,173,0
50924 data 220,41,2,201,0,208,3,76
50932 data 36,199,173,0,220,41,16,201
50940 data 0,240,57,32,5,199,76,222
50948 data 198,160,100,162,255,202,208,2
53
50956 data 136,208,248,96,32,116,199,206
50964 data 75,197,174,75,197,236,89,197
50972 data 208,186,238,75,197,76,216,198
50980 data 32,116,199,238,75,197,174,75
50988 data 197,236,77,197,208,166,206,75
50996 data 197,76,216,198,173,80,197,240
51004 data 40,160,0,173,91,197,133,251
51012 data 173,92,197,133,252,173,136,2
51020 data 133,254,169,0,133,253,173,92
51028 data 197,32,174,197,169,216,133,25
4
51036 data 169,0,133,253,165,252,32,174
51044 data 197,56,173,75,197,237,89,197
51052 data 172,81,197,208,2,169,0,96
51060 data 32,199,197,164,211,174,86,197
51068 data 177,209,73,128,145,209,200,20
2
51076 data 208,246,96,32,121,0,32,0
51084 data 226,224,37,176,91,142,74,197
51092 data 32,0,226,224,24,176,81,142
51100 data 75,197,32,0,226,224,37,176
51108 data 71,142,76,197,32,0,226,224
51116 data 24,176,61,142,77,197,32,0
51124 data 226,224,16,176,51,142,83,197
51132 data 32,0,226,224,2,176,41,142
51140 data 81,197,32,0,226,224,2,176
51148 data 31,142,80,197,32,253,174,32
51156 data 158,173,165,13,208,6,32,221
51164 data 189,32,135,180,32,166,182,142
51172 data 78,197,140,79,197,76,136,197
51180 data 76,72,178,240,256

```

ready.



Prime
Artifax



Mail Order
(02) 817 0011
Amiga
C64 & C128

HUNDREDS
MORE
TITLES
ON
LIST

Amiga - Accessories

Nashua Diskettes Box of 10	\$29.00
Disk Box - Holds 40	\$15.95
Disk Box - Holds 80	\$21.95

Amiga - Books

Amiga for Beginners	\$39.95
Amiga Tricks and Tips	\$49.95
Amiga Machine Code	\$49.95
Amiga BASIC	\$49.95

Amiga - Games

Name your game, and we'll get it for you! Or choose from these top sellers:-

Test Drive	\$54.95
Pink Panther	\$59.95
Ferrari Formula One	\$59.95
Interceptor	call

Amiga - Utilities

ARP 1.1	\$8.95
Anti-Virus-PAK	\$8.95

Amiga - Magazines

Australian Amiga Review	\$2.00
Amiga Live Twin Disk Set	\$24.95
Megadisc	\$19.95

Amiga - Productivity

Textpro	\$149.00
Beckertext	\$154.95
Analyze	\$219.00
Organise	\$179.00
Scribble	\$179.00
The Works	\$339.00
Publisher Plus	\$179.00
Excellence	CALL
Gizmoz 2.0	\$99.00
Fleet Check	\$54.95

C64 - Accessories

5 1/4 Inch Disks - pack 10	\$9.95
Slimline Case	\$24.95
User Port Expander	\$24.95
Mach Five	\$45.00
Dolphin DOS	\$179.00

C64 - Utilities

FINAL CARTRIDGE III	\$129.00
Action Replay IV	\$129.00
Pactornics PCD 5.25 Drive	\$349.00
Best DOS Utilities	\$16.95
MPS802 Publisher 2.0	\$24.95
Becker BASIC	\$95.00
Blitz! Compiler	\$44.95
D-Compiler	\$24.95
Kwik LOAD	\$12.95
MOUSE&CHEESE	\$119.00
VoiceMaster	\$79.95
Freeze Machine	\$89.00
Expert Cartridge 3.2	\$108.00

C64 - Entertainment

World Class Leaderboard	\$39.95
Wonderboy	\$24.95
Buggy Boy	\$34.95
Chuck Yeagar F.Sim	\$34.95
Marble Madness	\$34.95
Skate or Die	\$34.95
Yes Prime Minister	\$49.95

C64 - GEOS

GEOSMAN - Book & Disk	\$69.95
Utilities, instructions and help.	

C64 - Productivity

Mini Office II - DISK	\$59.00
Paperclip III	\$89.95
Kwik Write	\$39.95
Kwik File	\$19.95
Kwik Cheque	\$19.95
Magpie Database	\$54.95
C64 Cashbook	\$99.00

CALL
NOW
FREE
ADVICE

Send to: **Prime Artifax**, 23 Bonnefin Road, Hunters Hill, 2110 NSW
Or phone your order through on **(02) 817 0011**

Name:.....

Address:..... Postcode:.....

Mastercard Bankcard Expiry Date:..... (No credit card accepted without signature)

Signature:.....

Products required:..... add \$2.00 P. & P.

Adventurer's Realm by Michael Spiteri

HELLO! HELLO! HELLO! Welcome once again to the dark and mystic caverns of The Realm - Australia's only adventure column dedicated to Commodore computer users.

Adventure's Realm offers everything adventurers need, from special bulletin boards, through to hints and hint sheets, debatable debates, problems to solve, and space for you to air your grievances or just make a point. Most importantly, the address to write to is:

Adventurer's Realm 1/10 Rhoden Court
Nth Dandenong Vic 3175

I'll reply to any problems I can cater for, otherwise the problem will appear in the magazine. Please enclose a s.a.e or stamp in case I am able to reply.

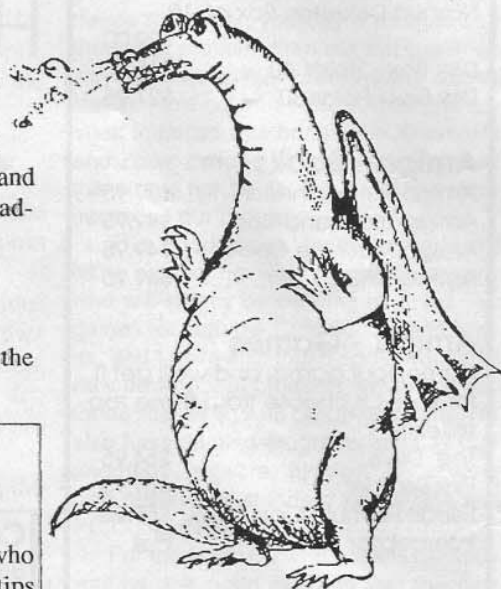

Stop Press: official Realm Bulletin Board set up in WA

Yes folks, Terminal BBS in WA has exclusive rights to all of the Realm's tips and hints. Free membership of this bright new bbs, with already over 200 members means, again, all it will cost you is the price of a phonecall. Terminal BBS accepts all baud rates, is available to all computer users, including C64 and Amiga owners. Another fantastic feature of this BBS is that users can take part in an on-line adventure game. Two have already been set up - *Running Man* and *Neverending Story*. The Realm database should be available by the time you read this - so log on and find out!!

Meanwhile, adventurers in NSW

should log onto Down Under BBS, who have exclusive rights to the Realm's tips in NSW and ACT. It should also be up and running now, and is also a free service offered by the Realm.

Don't forget these telephone numbers:
Terminal BBS (WA) Ph: (09) 389 8048
Down Under BBS (NSW)

Ph: (02) 674 6647

We are still looking for bulletin boards in Victoria, Queensland, South Australia, Northern Territory (?), and of course Tassie. Write to the Realm if you would like your BBS to be part of this new adventure network.

Realm's Debate Centre

Okay! This month we have a new debate rolling, covering a very controversial topic.

Over the last year there has been a trend by software firms to release adult oriented software. First Infocom released the mischievous *Leather Goddesses*, then Sierra with *Leisure Suit Larry*. Cinemaware have released such products as *Defender of the Crown* and *King of Chicago*, that aim at a more mature market. I want to know how people feel about this new trend in computer software. Should we welcome this form of adult software with open arms, despite how explicit it may become? And how is it affecting the younger generation?

If you are under 18, I'd like to know how easy it is to obtain such software, and if the under-age prevention techniques actually work. With such software being too easily accessible, and computers becoming even increasingly popular, is it really a threat to society? All views published.

Realm's Official Hint Sheets

Here is the current list of hint sheets now available from the Realm free of any charge. Please enclose a stamped address envelope large enough to hold the hint sheets you require (A4), and only ask for the ones you really desperately need.

Kabyashi Naru, *ZZZZZZ*, *Adventureland*, *Pirate Adventure*, *Faery Tale*, *Bard's Tale* (five pages), *Borrowed Time*, *Zork 1,2,3*, *Hitchhikers Guide*, *NeverEnding*

Story, *The Hobbit*, *Lord of the Rings*, *Hampstead* and *Castle of Terror*.

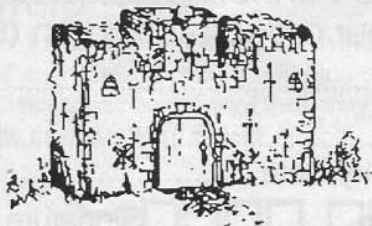

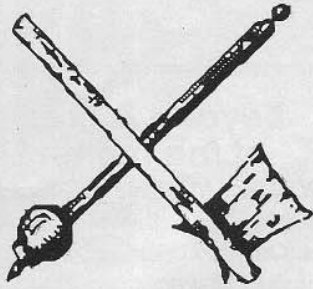

Realm's Chitchat

Kamikaze Andy writes "I'm rather puzzled about the 'spot illustrations' that are found in the Realm. So far I've seen an elephant, a butterfly, a hat, a servant, a housewife(?), and some balloons. What all these characters have to do with adventures, I'm not sure. Why not use pictures of monsters, treasure maps, swords, shields, dragons, etc?"

MS: Karla Slack is working on some adventure orientated drawings that aren't so violent, and these should appear in future issues of ACR. Meanwhile, we've tried to follow your suggestions in this Realm.

The Gatz Hacker writes "I think that some kind of yearly volume, compiling, cataloging and ordering of all of the Realm's hints, reviews, etc would be great for people like myself who have only just started getting *Australian Commodore Review*."

MS: I'll try and organise a quick review of all the year's games, plus hundreds of hints for either the *ACR Annual* or the Xmas issue. Keep reading this spot for more info.

Adventurer of the Month

This award goes to nobody in particular, since nobody did anything particularly fantastic this month.

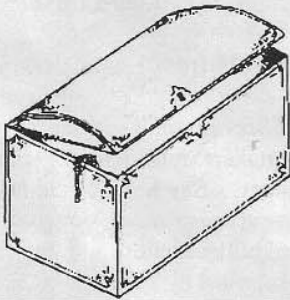

Troubled Adventurer's Department

Welcome to the land of the insane. A land where people become stuck in an huuge mountain of adventure games, and then find themselves suffocated with problems. Can you help?

Vivienne Slater, now a professional adventurer, has got herself stuck in places very few people have dared to ponder. In *Jinxter* she has been transformed into a guardian and is back at the NeverEnding Lane but is having problems with a bus that sort of, well, SPLATS her. Then in *Rigel's Revenge* (a game about a revenging Rigel), shooting soldiers are preventing her from getting into or past the hut after No Mans Land. Finally into the land of *Spellbreaker*, she has spent many an hour trying to feed a rock something phosphorus. Weird eh?

Lynn Jackson of Gwynneville in NSW is stuck in quite a few games. Firstly, she is sitting in a tip truck on a mining field in *Island of Spies*, but is so far unsuccessful in moving the truck! Then in *Temple of Doom* she wants to cross water (!). A certain *Lost Planet* has a green man guarding a mirror, and the game *The Lost Ones* has what seems to be an unclimbable cone-shaped hill.

"I am a very troubled adventurer" writes Risole (*MS: No. Don't write in and ask me if that's his real name or not*). Risole is stuck in *The Uninvited*. Here are his problems...

- 1) How do you get the key off the little Red Devil?
- 2) How do you get past the dogs guarding the chapel?

3) How do you get rid of the ghost in the bedroom?

Ricky Pezzimenti is stuck in *Labyrinth*. Yes folks, another maze sucks up a helpless adventurer. This time it's a hedge maze. Ricky is also stuck in *Grand Larceny*, and wants to know how to get to the very top of the building.

Andrew Kent is stuck in *Maniac Mansion* (disk version). How on earth does he get out of the dungeon? (Another maze, I think !)

Chris Coombes is back (did he ever go?) and is stuck in *The Pawn*. He is stuck in the paper wall room. Once before he managed to get down to the cream doors but he can't remember how he did it. And when he does get down to the cream doors, how does he get past them?

David Newmann is stuck in a quad of games...

Lord of the Rings Pt2: How do you cross the river in Lothlorien? *Hacker II:*

How do you tell the MRU to do anything in MRU Command Mode? *Labyrinth:* After killing the guards, how do you enter the castle? *Holy*

Grail: Where do you take the Grail?

A chap called Aaron is stuck in *Aztec Tomb 1*. He can't get out of the garden! He can get past the bull into the waste yard but no further.

Kamikaze Andy is stuck in *Jinxter:*

- 1) What do I do with the flies?
- 2) How do I open the door in the castle?
- 3) How do I get past the Green Witch, Jannedor?

Jonathon Robinson of Attwood is stuck in *King Solomon's Mines Pt1*. He wants to know what items he should buy from Trader Jim's Outpost. He is current-

ly stuck in the ravine and doesn't know where to go or what to do from there.

Shane Whalen of Chapman in *ACT* is stuck in a couple of games. In *Magician's Ball*, he doesn't know what to use to kill the magician and how to do it? The other game is *The Bard's Tale*. He wants to know how to get into the fourth level of *Mangor's Domain*.

David Couche is having problems in

The Pawn. Once you get past the snowman, how do you open the heavy doors, and how do you open the safe in the office?

Finally, Ron Abernethy of Northcote in Vic has the following problems -

The Temple Curse: How do you get into the boat?

Jack the Ripper: How do you get out of the motel without being arrested?

Help for Troubled Adventurers

(or . . . *The Smart Adventurer's Department*)

Many thanks to all those who wrote in giving help to the poor demented souls that appeared in previous issues.

For: Walter Brank

From: Suzanne Parkes and David Couche and Noel McAskill and Mannequin

Game: *The Pawn*

Help: Give the guru some fresh water and he'll make sure you find some light. You'll find some money in the dwarves house in the residential area and you can also use the chit you find elsewhere to buy from Honest John. Just throw the white (light) at the snowman.

For: M Morris

From: Suzanne Parkes and Noel McAskill and Mannequin

Game: *The Pawn*

Help: The devil will give you the poison, just ask! Give Jerry Lee a beer, buy you can't pass him. You just collect points.

For: J. Waller

From: Suzanne Parkes and Lynn Jackson and Chris Sims

Game: *Island of Spies*

Help: Get Parachute. Wear Parachute. Pull Lever. Pull Ripcord.

For: John Fulton

From: Vivvienne Slater

Game: *Lord of the Rings*

Help: Get Merry to swim in the lake.

For: Suzanne Parkes

From: Vivvienne Slater

Game: *Guild of Thieves*

Help: Spell the word backwards to cross the coloured squares.

For: David McKinney

From: Mannequin

Game: *Classic Adventure*

Help: Give the egg to the troll.

For: Mrs Walker

From: Chris Sims

Game: *Temple Curse*

Help: To escape from the pool, row east, row west, row south.

For: Anne Barnes

From: Chris Sims

Game: *Lost Planet*

Help: From Limestone Cave, go n.n.s.e.w. To return go e.s.s

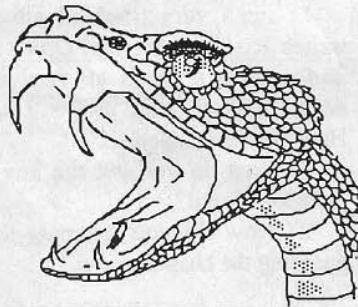
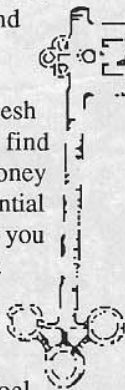

Beyond Zorker of the month

Well-named Risole gets this award for asking for a *Beyond Zork* hint sheet. Only a Zorker would ask for a hint sheet that doesn't exist yet.

General hints for Magnetic Scrolls adventure games

Guild of Thieves

- To open the opaque case, get all 4 coloured die, go to the case and roll all the die until they come up with 5. Insert the respective coloured dice into the coloured slots.

- For the cauldron, the ingredients can be learnt from the macaw.

- The plastic bag, designer dress, china pot, ruby, chalice, and ring are some of the many treasures. Deposit all 15 treasures in the night safe to open the Bank.

- Use the pick to get the mineral chips, and the spade to open the coconut.

- Use the mirror to reflect the beam of light on the wax and melt it to get the gem.

Jinxter

- The plastic key can be melted to fit a certain unopenable mailbox.

- Listen to the magpie to get something useful.

- Get rid of the clockmaker by distracting him and throwing something at the oil lamp.

- The sock and bungare useful for canoe holes.

- The can of worms are useful for dirt mounds

(Above tips supplied by Kamikaze Andy)

The Pawn

- There is an IOU from Honest John in the fountain.

Guild of Thieves

- At the undertakers, raise flap to get behind the counter. - Say hello to the Myrah bird.

- Open the red billiard ball.

(Above tips supplied by Tex)