

Vol 4 No 8

August \$3*

The Australian COMMODORE and AMIGA REVIEW

**Finding a
top class
disk drive**

Reviews:

Road Runner
Freeze Machine
Euphony
Virtuoso

Eagles
Xevious
Flyspy
Trap



Programming:

User Defined Characters
Basic is Easy
Dice Roller
Fast Change Button

Regulars:

Super Column
Arcade Action
Machine Code

FREEZE MACHINE



DISTRIBUTED BY
MICRO ACCESSORIES OF S.A.

MADE IN SA



The Australian Commodore and Amiga Review

Vol 4 No 8 August 1987

CONTENTS

HARDWARE

- 6. **Freeze Machine** - the latest in frozen techno-gadgetry
- 8. **Disk Drives Directory** - such a big selection. Which one should I buy?

SOFTWARE

- 14. **Game of the Month - Road Runner** - cartoons must elusive character has finally been captured!
- 16. **Behind the Screens** - the games Eagles, Xevious, Flyspy and Trap
- 24. **Crossword** - the latest from Uncle Pete
- 28. **Virtuoso 64** - a powerful and flexible music editing system that takes your C-64 to its musical limits
- 32. **Euphony** - details about the updated program
- 37. **Fast Change Button** - modifying Fast Load for the C128
- 42. **The Super Page** - the use of surnames etc as key fields has a problem.

AMIGA TODAY

between pages 24 and 25

PROGRAMMING

- 33. **One Liners** - a couple of quick routines
- 34. **Define your wishes** - multi-coloured characters, memory positions, and UDG's
- 40. **Machine Code Tutorial** - first of a regular tutorial on binary and other mysteries
- 44. **Dice Roller** - display in large sprites your roll of the dice.
- 47. **Basic is easy** - an introduction to the world's most popular language

Australian Commodore Review
Top Rear, 4 Carrington Road, Randwick,
NSW 2031 Phone: (02) 398 5111
Published by: Saturday Magazine Pty Ltd.
Editor: Andrew Farrell
Advertising: Ken Longshaw (02) 398 5111
Production: Brenda Powell
Layout: Amanda Selden
Subscriptions & back issues:
Tristan Mason (02) 398 5111
Distribution: NETWORK
Printed by: Ian Liddell Commercial Printing

REGULAR APPEARANCES

- 2. **Editorial**
- 3. **Ram Rumblings**
- 4. **Letters**
- 25. **Arcade Action**
- 40. **Machine Code Tutorial**

Editorial



NO DOUBT you welcomed the unannounced increase in thickness of last month's issue. Including the Amiga section, we now boast 64 pages of juicy magazine for you to read. Compare that with the overseas magazines landing at your newsagent for around \$7 and you're talking value plus.

In the past we have encouraged your ideas, brickbats or bouquets. To the larger degree we have taken much notice of these. There are more programming articles, fewer games reviews, more tutorials, and starting this month we've added a guide to BASIC and machine

code.

As far as possible, regular items such as Adventurer's Realm, Arcade Action and Paul Blair's Super Column, will appear.

Amiga articles will still appear in the main body of the magazine.

However, these will be directed at non-owners. That will leave more space for 64 users. If there's anything you'd like to see that we're not doing, please do write in as soon as possible.

This month, we examine all the disk drives Commodore has ever released, and explain just what they can and can't

do. We also review the latest in alternative units, a slim-line from Micro Accessories.

Jason Briggs continues his guide to User Defined Characters, and Eric Holroyd, our music man, examines *Virtuoso*. This program allows you to produce a stand-alone program that will play your tunes. Add to your own games for background music or effects.

Freeze owners will also be pleased to read about the latest version, now called the Freeze Machine.

Full review inside.

Enjoy.

Andrew Farrell

Make sure of getting your copy - subscribe now!

The Australian Commodore Review DIRECT SUBSCRIPTION

Please enrol me for issues subscription to The Australian Commodore Review, commencing with the issue. I enclose a cheque/money order for \$

OR

Please charge my Bankcard or American Express card, number
Expiry date

Name:

Address:

. Postcode

Rates within Australia:
6 issues \$18.00 (including postage)
12 issues \$34.00 (including postage)

TO: The Australian Commodore Review
Top Rear, 4 Carrington Rd
Randwick NSW 2031.
☎ (02) 398 5111.

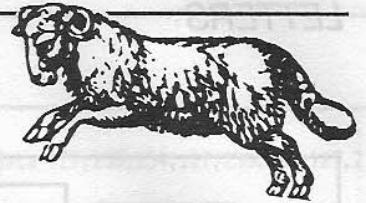

RAM RUMBLINGS

Commodore announces \$100 million Indian contract

Commodore Australia announced a major contract with a multi-million dollar computer company in India.

The deal involves a five year \$100 million manufacturing and technology transfer program with Commander Computers Limited of India.

Commander Computers is 60% owned by Commodore Computers Inc. of the U.S.A., 20% by the State Government of Orissa and 20% by public issue.

The contract involves the supply of computer components for final machine assembly in India and marketing throughout India by CC.

The completion of the negotiations were made by the Australian and Asia/Pacific Managing Director, Mr. Tony Serra, with the assistance of the Asia/Pacific Manager, Mr. Ron Webb.

Mr. Serra said, "A lot of time and effort from all areas of the Commodore Company went into the planning and negotiations to secure this contract."

The potential market in India is about 10% of the population base of over 700 million. In addition the Indian government has committed itself to a policy of having computers in every school within the next three years.

Mr Serra said, "The machine assembly will include the C64, 128, PC and Amiga products of the Commodore range." Production will start immediately and launch date for the products will be mid September with U.S.A. and Indian government involvement.

"We see India as a more lucrative short to medium term market for the computer industry than China. The simple fact of not having to overcome the barrier of machine and software language is a major bonus in dealing within the Indian market.

"In May 1986, we announced a five year plan for Commodore in the Australian and Asia/Pacific marketplace whereby we would be more aggressive and market orientated enabling us to become a \$100

million company by 1990.

"The reaction to our push may very well see us at that level in the region by the end of fiscal 1988," Mr. Serra said.

\$12 million printer agreement

Commodore Computers signed a \$12 million agreement with Sydney based computer peripheral distributor IPL-Datron to market a range of PC printers.

Under the two-year agreement, IPL-Datron will supply laser, dot-matrix and thermal printers for Commodore. The printers will service the entire range of Commodore computers from the C64 for the home market to the complete range of IBM-compatibles and the Amiga for the business sector.

According to Commodore's Australia/Asia Pacific Managing Director Mr. Tony Serra, the printers will be tailored to Commodore's specifications.

Mr Serra said the agreement was the first regional deal made by Commodore which usually bought on a global scale.

"The Australian market is particularly sophisticated," he said. "While Commodore is relatively more successful in Australia than other parts of the world, we want to make a strong impact on the business market. This means we urgently need quality printers to match our business computers."

The agreement will position Commodore as a major market force in the business printer sector.

"The printers will be so keenly priced that it will be difficult for anyone to overlook them," Mr Serra said

For IPL-Datron, the agreement marks its biggest OEM contract.

IPL Managing Director Stead Denton said, "We believe this is the biggest OEM printer deal ever made in Australia.

"We were able to offer Commodore a range of printers which provided quality, market acceptance, versatility and adaptability to their need."

The printers include the Oki Laserline 6 laser printer which will be fully developed to HP+ specifications for Commodore, 10 inch and 15 inch dot matrix print-

ers with single and dual 9 pin print heads and a no-impact thermal printer.

Mr Denton pointed out that IPL-Datron was a specialist OEM supplier to the Australian market, able to assure Commodore that they would not compete for sales.

"Our policy is that we never sell direct to government or corporations, an important aspect of Commodore's new thrust into the business market."

Mr Denton said that IPL-Datron was probably already the third largest supplier of printers to the Australian PC market.

"We don't show up in any of the industry surveys because we don't subscribe to them," he said. "The contract with Commodore will bring us very close to the leaders."

FREE SOFTWARE for COMMODORE 64/128

Any one of these four programs:

- Race Selections Analyser
- Lotto Selections Analyser
- Typing Tutor
- Maths Tutor

on disk or tape, will be yours **FREE**,

when you buy our new book:

COMMODORE 64/128

TREASURE CHEST,

a compact and handy guide, full of unusual programs, subroutines and programming hints. Make your own programs using POKES, PEEKS, USR, SYS and other tricks.

For details of book contents send your stamped and self-addressed envelope without any obligations.

Price of book is **\$23.00** post incl. Please send cheques or money order to:

APEX COMPUTER PRODUCTS

35 Spruce St, Loganlea
Qld. 4204

LETTERS

TO THE EDITOR

MPS 1200 vs 1541 problems solved!

I am writing to you in the hope that, through your magazine, no-one will have to go through the same situation as I was recently in. After many years of using a C 64, 1541 drive and 1525 printer (so many years the drive and C64 both cost me \$699 each), I decided I needed a better printer, so eight weeks ago I bought a MPS1200 (for \$489, they were \$349 at the Commodore Warehouse Sale and racing out the door, when will I learn?).

As soon as I connected up the MPS1200 it became obvious there was a compatibility problem as the drive went crazy if the printer was on line and I tried to access the drive, I got "device not present", "file not found", "drive not ready" etc etc. So I rang Commodore: after ringing several times a day for sev-

eral days and not being able to contact "technical support" I started to wonder if they existed (they are in meetings, on other lines, out to lunch, or "nobody seems to be answering at present, could you try again later") and so talked to "service" who couldn't help, except to refer me to a service agent who kept the printer for two weeks, found no problem, so kept the drive overnight, returned the lot saying they didn't know what was wrong but if it didn't go away to bring the lot back. After their first effort they had to be kidding. Again I rang Commodore, again "technical support" were regularly unavailable. Over the next few weeks I spoke to three other service agents but their lack of ideas of what the problem could be was so uninspiring I didn't let them have a chance.

Then, about two weeks ago I

wrote to Commodore, no reply as yet. Finally I talked to Brian Fielding and crew from CTS (Commodore Tech Services of Carlton) who were at Commodore's Warehouse Sale. They thought a chip in the earlier 1541 drives may cause the problem so I bought a replacement, fitted it, and no more problems.

So, if anyone with an old 1541 is having trouble with a MPS1200 connected, changing the 901229-03 chip for a 901229-05 might save you a lot of trouble.

Stephen McEwen
Orange, N.S.W.

Printer compatibility

I recently purchased an MPS1200 Commodore printer to use with my C64. I must say that until I read a review in your magazine, about three months ago, I was unsure as to which brand of printer to

PRINTER COMPATIBILITY CHART

CPU TYPE	MPS 1250	DPS 1101	MCS 810	MCS 820	MPS 1280	MPS 2020	LP 806
64	YES	YES	YES	NO	NO	NO	NO
128	YES	YES	YES	NO	NO	NO	NO
128D	YES	YES	YES	NO	NO	NO	NO
Amiga 500	YES	NO	NO	YES	YES	YES	YES
Amiga 1000	YES	NO	NO	YES	YES	YES	YES
Amiga 2000	YES	NO	NO	YES	YES	YES	YES
PC 5	YES	NO	NO	YES	YES	YES	YES
PC 10	YES	NO	NO	YES	YES	YES	YES
PC 20	YES	NO	NO	YES	YES	YES	YES
PC 40	YES	NO	NO	YES	YES	YES	YES

N.B. Parallel connecting cables are not supplied with printers but are available as options.

Specifications subject to change without notice

purchase. I think after using the MPS1200 myself, that this is a very good quality printer.

My question is, if at a later date I update my computer from the C64 to an Amiga 500 or 2000 can I still use the MPS1200 printer.

I have been reading your magazine for the past two years and I think that the articles in it are very well put together. I especially like the machine code programs that are printed in assembly code.

Alex Martin
Ocean Grove, Vic.

Ed. Any printer with a parallel port will work with the Amiga range. (see chart).

Our magazine

Having just read the June edition of *Australian Commodore Review* I feel inclined to make a few comments.

I was not impressed with the article on Programmable Characters. It appears to be a verbose rehash of the contents of pages 108-114 of the *Programmers Reference manual*.

It is my opinion that the four pages devoted to this article could have been better used for things not in a book nearly every C64 owner has a copy of. The missing *Adventurer's Realm* or a few hardware reviews would have been better.

I was so impressed, however, with the article on the contents of *Disk Magazine Six*, that I am sending you a cheque for one. It seems to be exceptional value for \$12. (I would also be very interested to read more about the "inexpensive digitiser" mentioned in that article.)

Michael Boyes
West Pennant Hill, N.S.W.

Ed. It is a sad fact that not that many do have a *Reference Guide*. We get constant requests for memory maps all of which appear in the *Guide*. Glad you like the disk magazine — we'll keep it coming!

Pen Pal

I just thought I'd write to congratulate you on an excellent magazine. I just bought my first issue and find it much better than the overpriced American magazines I used to buy.

How about starting a Pen Pal column? I think this would be a great idea. Could you please publish my full address. I would like to get in touch with anyone aged 13+, male or female who uses a 64.

Nic Atherden
7 Carter Street
Randwick, N.S.W

Ed. Ok, Pen Pals start writing!

Circuit diagrams

I am an avid reader of your magazine, although not yet a subscriber. I am wondering if you could possibly help me, or advise me on how to go about obtaining a circuit diagram for a Commodore C128D and the Commodore 1901 colour monitor.

I have been to see a number of Commodore stockists, and they all advised me to try Commodore themselves. However, after writing to them a number of times, the last time being on 2nd July 1987, it would appear to me that they are not at all interested in purchasers of their equipment, who may have technical enquiries to make.

Keep up the good work with your magazine, which as far as I am concerned is the best magazine on Commodore available in Australia.

Ricci Green
Belrose, N.S.W.

Ed. Call Gabe at Sydney United Computers (02) 295 5088

Printer Problems

I have a 128D with a Compute Mate-100 Parallel printer with a Xetec Suter Graphix Jr. interface. The problem is when I am using *Certificate Maker*, *Printmaster*, *Printshop*, *Dooble* or any graphics programs, the printout is only about 50 charac-

ter wide instead of 80 character.

Please could you tell me how I can fix this problem as I have tried everything. I have switched all function switches on the Super Graphix, tried all of the print codes in the program and in the printer, it will print 80 character in text mode.

R.E. Melksham
Carole Park, QLD.

Ed. A graphic dump is only 50 characters wide - you can't stretch out what ain't there.

Garfield

I have recently discovered that the *Artist 64* can be used to combine the graphics with *Garfield*! I have also found out it also will work on *Teddy Bear-Rels of Fun*. You simply save your graphic with the *Artist 64* and then leaving your data disk still in the drive, type

Load"P-(filename)",8,1

and then when it has loaded type this :

Save"(CRTC0>(filename)",8,1

But this will be a Cartoon and won't be able to be loaded normally as an Electronic Cartoon slide show.

Shane McGregor
Merrylands, N.S.W.

BACK ISSUES

are still available

for only

\$2.00 each

Just give **TRISTAN**

a call

on

(02) 398 5111



Presenting the Fabulous Freeze Machine

In a mere matter of manic moments you can speed up a load, save your favourite protected program or format a floppy. All this and more using the latest in frozen techno-gadgetry from Micro Accessories. Andrew Farrell, the man with more computers than a Commodore warehouse, donned his Bolle's for this report.

YES folks, it's all true - and I did write that intro. Kiss goodbye to *Freeze Frame 3B,D* or even *Freeze Frame Five*. They've gone one better and named it the *Freeze Machine*. This time there's two buttons, and two modes of operation.

Default power up mode displays a blue screen on a blue background. This is the fast load menu. Press the right button, and bingo, a red screen on a red background appears. This time you're in Lazer mode. Each of these mysterious menus provides a unique set of operations and commands.

The instructions included throw little light on the real capabilities of this device. Instead they make the whole affair sound more like an adventure game, complete with appropriate puzzles and mysteries to solve.

To quote a hint sheet I received on the device:- "Experimenting is by far the best way to learn more about this product".

What is it?

For the uninitiated, *Freeze Machine* was originally a copy device. It works by snap-shooting the entire memory of the 64. This is then compacted and rearranged before being saved to disk. The result is a fast load version of your favourite commercial program on disk, or cassette.

However, this latest version includes something more. A fast load system called Lazer Boot and a fast load system called Fast Load. Using the first format, normal programs may be converted to the Lazer arrangement, which stores data as *USR* rather than *PRG* files. The best part about the system is that you don't neces-

sarily need the cartridge in place to use it.

Lazer Boot

A program(s) is saved at the start of your directory that acts as a boot up for the disk. In other words, load this little proggy first, and it transforms all future loads into Lazer speed. Simply select from a menu the program you wish to load, and away you go.

Sounds simple, but on my first attempt I discovered that either the loader is temperamental or I had followed the contorted instructions incorrectly. My program would not load and run. I asked Micro Accessories for better instructions. A hint sheet promptly arrived. I would have thought simple instructions rather than vague hints would have been better. Nevertheless, I pushed on and tried again.

To establish what the difference was between the fast load and lazer load system I tested both out and timed the difference. In the process of describing what I'm doing, I hope to throw a little light on how to use this product. Perhaps Micro Accessories would like to use the remainder of this article as a rough for their new instruction book.

Test Drive

(The rewritten instructions.)

How to Use the Fast Loader :- First, from the blue menu screen, format a disk. After fifteen seconds a directory of your disk will appear. Pressing the space bar will return you to the main

menu. Now choose 'I' to install the fast boot.

After about five seconds, the disk directory will appear, this time with the files *BOOT* and *MENU*. Press the space bar to return to the main menu. You can now save files onto this disk.

At this point I exited from the *Freeze Machine*, and wrote a two line program that printed "I'M RUNNING" all over the screen. I saved this to the disk I had just prepared. According to the instructions, you can now *BOOT* the disk. Type *LOAD"0:"*,8,1* and the boot program loads the menu program which then loads the disk directory. This is then listed to the screen.

“Experimenting is by far the best way to learn more about this product.”

To *LOAD* and *RUN* a program, move the cursor up to the appropriate line and press return. My program loaded, but the whole operation seemed to bomb out, and the run was never executed. I typed *LIST* and all seemed to be in tact. So, there is a glitch guys - hope you can fix it.

The *FAST* loader was fast. My program loaded in just under three seconds, compared with just under three seconds for a normal load. Mmmmm.. perhaps I should use a bigger program, so that the difference is more obvious. So, I dug up my trusty modified version of *Easy Script*. After 37 seconds of standard loading time it was in memory and ready to be saved onto the fast load disk. This I did.

Again, I loaded the *BOOT* program, and from the directory pressed return on the same line as the *EasyScript* file appeared. After just over eight seconds it had loaded.. but did not *RUN*! You don't necessarily need the cartridge in place for this option to work.

How to Use the Lazer Loader :- Simple. Do exactly as you did for the fast loader, except that now instead of SAVING files you want directly onto the LAZER BOOT disk, you must convert them. Select 'U' for utilities from the red menu screen. Now choose the 'x' option to convert files.

Insert a disk and press 'Y' or 'N' to choose which files you wish to swap over to LAZER format. These will then be loaded, and a prompt appears to insert the destination disk. I tested this option out using EasyScript, which is about 57 blocks long. This time loading was further improved down to an amazing 6 seconds. After being converted the file was slightly larger - up to 61 blocks.

Now the difference is obvious. The Lazer Loader, although more cumbersome to setup, is much faster. Rather than loading the menu from disk. the

same program is built into the cartridge. When in position, just move to the right menu, get a directory and press return on the file you wish to load.

Freeze Facilities

This is the sensitive part of this device. By rights, I don't even feel sure I should be discussing it. Yes, it is for backing up programs. You can save your copied files to either Lazer or Fast load format. Or you can save it as a normal programs file - for use with Dolphin DOS or similar.

Novaload programs may be backed up, and there's also a game killer option. This little piece of trickery can try to turn sprite collision, and/or background collision off. This is great for trying to get through games that are just too tough.

Some caution is required. Only try

this modification on your backup copy of the program in question.

Conclusions

Freeze Machine is without doubt a big improvement over earlier. There are a dozen more features I haven't mentioned, all menu driven. The only two downfalls are the obscure documentation and the fact that neither fast loader will correctly run a program. I hope both these problems will be fixed soon.

Just what the new snapshot facilities will copy is not a good subject for this magazine. However, I'm sure it is very good.

Micro Accessories will be publishing a newsletter to keep owners up to date with developments, so you will be well supported for the \$108 this little baby costs.

Keep up with Commodore at Maxwell The Commodore Centre

The largest range
the very latest and

No. 1
for

**SALES, SERVICE
and SUPPORT**



500/1000/2000

**SYSTEM &
PACKAGES**



Sidecar, Hard Drives 3½" & 5¼" Drives, Parallel & SCSI Drives, Digitisers, EasyL, Penmouse, Synthesizers & M.I.D.I., Graphics & C.A.D. Music & Sound Samplers, Games & Business, Color Dot Matrix, Thermal & Inkjet Printers, Desktop publishing.

*** NEW RELEASES ***

Butcher, Dimmer, Flipside, Parhome, Phasar, Maxiplan Plus, Prism, Best Acc., Pro-video CGI, Digiview II, Supra Drive, Guild of Thieves, Power Windows, Cli Mate, FS Scenery II, Custom Screens, Delux Video 1.2, Kings Quest III, Flight Sim. Cable.



C64/128

1201/1802/1901 Monitors, 1541C/1570/1571 Disk Drives, Cartridge Expanders & Joysticks, 128 Ram Expansions, Lightpens, Mouse EPROM programmers & Blank Cartridges, Business, Accounting, Word Processing, Databases, Spread sheets, Inventory, Gen Ledger, Languages, CAD.

*** NEW RELEASES ***

Graphics Galleria, Flight Sim, Japan & Star Disk, Mario Bros., Air Combat Emulator, Artist 64, Geos. Prog. Ref. Guide, Geos Printer Cable, IBM to 64 Printer Cables, 64 Serial to RS232 Faces How to get the most out of Geos Disk, Army Moves, Disector V Wonder Boy, Barbarian, Family Feud, BBS 64/128, Stifflips.



5/10/20/40

**COLOR &
MONO
SYSTEMS**



Hires Mono, Hires Colour, Business Software, Hard Drives, Hard cards, AGA cards, Multifunction Cards, Mouse & Joysticks, Ram upgrades, Package offers.

*** NEW RELEASES ***

OMNI 123, Retailer, Motor Trader, Rental Manager, PSI 5 Trading Co., F15 Strike Eagle, Mean 18, Conflict in Viet Nam, Boulderdash II, Star Trek, Top Gun, Great Escape, Kings Quest, Silent Service, Dam Busters, Championship Boxing.

MAXWELL 162 NICHOLSON ST., ABBOTSFORD 3067 • PHONE (03) 419 6811 • VIATEL 64266

Disk Drives Directory

by Andrew Farrell

When we piled them on top of each other, even Commodore was surprised just how many existed. Add third party devices and you have one awful large selection to choose from. Andrew Farrell takes a guided tour of the range.

SMALL, fast, fat or thin. Different colours, speeds and capacities. Some compatible, some not so compatible. Which model will do the job you need, and where you can grab hold of some of those rarer models, is the subject of this article.

There are two main breeds available, serial and IEEE. The latter was designed for Commodore's older range of CBM machines. However, using an interface it is possible to operate an IEEE disk drive via the usual serial port. Bulletin boards commonly operate on these drives due to the large capacity. Program developers also find them useful for the same reason. With some variation, there are roughly six drives which fit the IEEE category. These all have obscure names and vary primarily in capacity and number of drives per unit.

Hard disks

Two hard disks are available. These have been copied in various forms by third party suppliers, and we may begin to see more of these readily available in Australia soon.

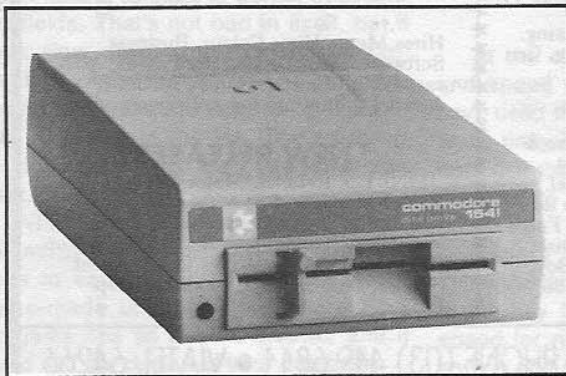

Imagine almost 8 Megabytes of storage and you have a top of the line D9090. At under \$500, you can't go far wrong if you're considering a setup that requires high-speed mass storage. Higher capacity is available for a whole lot more bucks. In fact a total of \$1850 will buy you a 10 Megabyte ST10C, Miniscribe drive with Commodore interface. Both the D9090 and the ST10C can be purchased through Graham Lee.

The man who pioneered bulletin board systems in Australia is now not only selling the software to run them, but the hardware as well! Catch Graham during the day on (02)665 0111 - and don't forget to mention where you saw his number.

He also sells the Leading Edge IEEE interface, a necessary evil if you plan to use any IEEE device with a Commodore 64.

Both the D9090 and its smaller cousin, the D9060 are cumbersome and heavy. The smaller version has a meagre 5 Megabytes of storage. Once up and running, both these beasts are best left alone. Parts may be hard to come by, and not all dealers can service these older units.

Dual drives

In our next category are the IEEE dual drives, which



are still around in good number. The 8250 and 8050 are very similar. The former boasts just over 1Megabyte per drive, whilst the other is just on the 520K mark. Both require double sided double density disks to operate reliably. These are a little more expensive than usual.

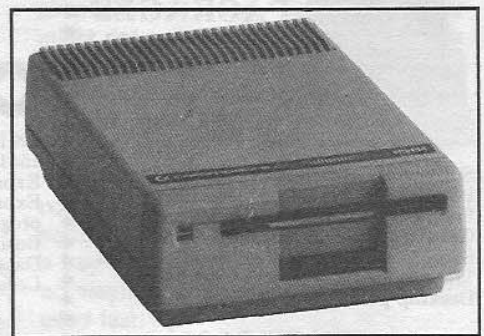

Commodore 1561

Once again, an ideal way to set up a BBS system that may have several disks full of software for downloads. These can be mounted or removed from the floppy drives, whilst a hard disk does the job of keeping track of members and messages.

The DOS format of all the 8250 and 8050 is NOT compatible with the 1541. However, the dual drive 4040 and single drive 2031 are close enough to be able to read and write 1541 format disks 99% of the time. These are often used for disk software production.

Some IEEE interfaces support DOS

4.0. This means you can use simple commands to copy or format disks. Alternatively, why not purchase an old PET, and like I do, use it for achieving or just a spare computer to view disk directories.

Single Serial drives

Now to the more familiar names such as the 1540, 1541, 1570 and 1571. One not so familiar might be the 1561. This miniature drive, the one on top of the pile on the picture, is a 3 1/2 inch version of the 1541. It was never released in Australia, and you can't buy one anywhere that I know of. It was slightly faster, and more reliable than its big brother, but never made the big time.

Vic 20 owners may remember the 1540. Originally in a creamy colour, it was the

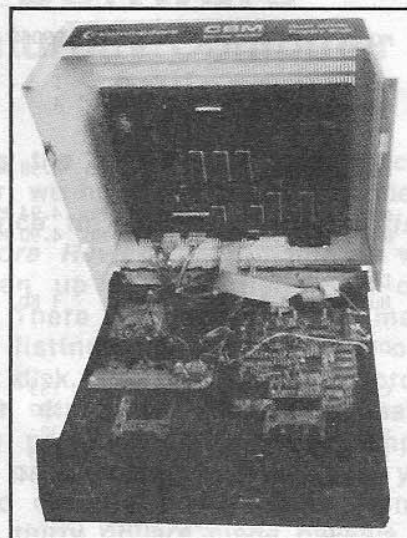

Commodore CBM 8040

first single drive that followed the new sleeker styling of Commodore's consumer range. The sleeker lines I refer to are those which followed the demise of the

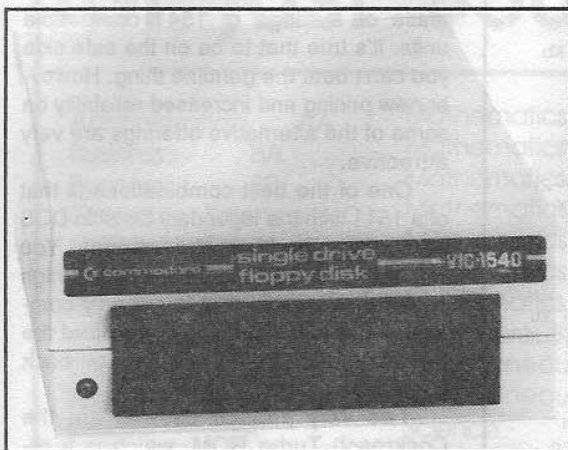

Commodore C64 PROBLEMS?

HERE IS YOUR NO FUSS SOLUTION

A RETURN MAIL BOARD EXCHANGE SERVICE

INCLUDING 3 MONTHS WARRANTY
AT AN UNBEATABLE PRICE OF

\$89.00 INCLUDES
POSTAGE AND HANDLING

*Simply undo a few screws to remove your computer board from its casing and unplug power lead and keyboard connectors.

*Your board must be complete with all chips etc. and must be in a serviceable condition.

*CHECK your power supply is not at fault before sending your board.

*Your exchange board is sent by certified mail the same day we receive your board. Full re-assembly instructions included.

Mail securely packed board with remittance of \$89 to :-

PARCOM PTY. LTD.

FREE POST NO. 9 CARINA QLD.4152

PHONE (07) 395 2211

BANKCARD-CHEQUE-POSTAL ORDER

NAME.....ADDRESS.....

PC.....

PHONE.....PAY BY CHEQUE.....BANKCARD.....POSTAL ORDER.....

CARD NO.....EXPIRY DATE.....

SIGNATURE.....DATE.....

COMMODORE DISK SYSTEM SPECIFICATIONS

MODEL	D9090	D9060	8250	8050	4040	2031
Drives per Unit	1	1	2	2	2	1
Heads per Drive	6	4	2	1	1	1
Formatted Storage Capacity per Unit	7.47 Mb	4.98 Mb	2.12 Mb	1.05 Mb	340 Kb	170 Kt
Max Sequential File	7.41 Mb	4.94 Mb	1.05 Mb	521 Kb	168 Kb	168 K
Max Relative File	7.35 Mb	4.90 Mb	1.04 Mb	183 Kb	167 Kb	167 K
Disk System Buffer RAM (Bytes)	4 Kb	4 Kb	4 Kb	4 Kb	4 Kb	2 Kb
DISK FORMATS						
Cylinders (Tracks)	153	153	77	77	35	35
Sectors/Cylinder	128	192	-	-	-	-
Sectors per track	32	32	23-29	23-29	17-21	17-21
Bytes per sector	256	256	256	256	256	256
Blocks Free (Unit)	29162	19442	8266	4104	1328	664
TRANSFER RATES (Bytes/Sec)						
Internal to Unit	5 Mb	5 Mb	40 Kb	40 Kb	40 Kb	40 Kb
IEEE-488 Bus	1.2 Kb	1.2 Kb	1.2 Kb	1.2 Kb	1.2 Kb	1.2 Kb
ACCESS TIMES (Milli-seconds)						
Track-to-track	3	3	5	*	30	30
Average Track	153	153	125	**	360	360
Head settling time	15	15	-	-	-	-
Average Latency	8.34	8.34	100	100	100	100
RPM	3600	3600	300	300	300	300
* Track-to-track: Micropolis 8050 = 30 ms. Tandon 8050 = 5 ms.						
** Average Track: Micropolis 8050 = 750 ms. Tandon 8050 = 125 ms.						
PHYSICAL DIMENSIONS						
Height (in.)	5.75	5.75	7.0	7.0	7.0	5.5
Width (in.)	8.25	8.25	15.0	15.0	15.0	8.0
Depth (in.)	15.25	15.25	13.75	13.75	13.75	14.25
Weight (lbs.:	21	21	28	28	28	20
ELECTRICAL						
Power (watts)	200	200	60	50	50	40
Voltage (all Models)	110 - 120 VAC, 60 Hz					

boxy PET range.

The primary difference between the 1540 and the 1541 is that of speed. Although the 1541 will work with a Vic 20 the 1540 will not work with a Commodore 64 unless you issue a special command. All of this is of course irrelevant since the 1540 is no longer available.

Its successor operates at around 300 CPS, which is slow by any standard. Since its release there have followed a swag of speed-up devices ranging from plug-in cartridges to complete ROM changes and cable variations.

As an interim step to supporting the newly released C128, Commodore provid-

ed the 1570. Much higher data transfer rates are supported, however only single sided formats may be read. The 1571 solved this problem, providing a drive which is reasonably compatible with the 1541 whilst being able to handle a host of new formats.

Big Blue Reader demonstrates the flexibility of this new drive very well in that it reads and writes MSDOS disks with ease. The same drive is also capable of reading and writing single and double sided MFM CP/M formats including EPSON QX-10, IBM-8 SS and DS (CP/M 86), KAYPRO II and IV AND OSBORNE DD.

C128 owners can only make use of the 1571's improved facilities in 128 and CP/M mode. For compatibility purposes it's often handy to have a dinky-di 1541. Copy protection on many games is exceedingly fussy, occasionally refusing to work with the newer drives.

For the Commodore 64 owner, several options are available following the release of a range of 1541 compatible units. It's true that to be on the safe side you can't beat the genuine thing. However new pricing and increased reliability on some of the alternative offerings are very attractive.

One of the best combinations is that of a 1541 with the legendary Dolphin DOS as supplied by Micro-Accessories. You will then have a state of the art high speed disk system that is not only compatible but reliable. If you can't afford the \$170 this extra luxury will set you back there are cheaper alternatives.

Two very popular choices are the Cockroach Turbo ROM, which is a replacement ROM for the computer, and the EPYX fast load cartridge. Both offer additional commands to make better use of the improved loading speeds attained.

At this time we're on the brink of a new ROM release for the 1571. I can only recommend that you delay any purchases where possible until the upgrade has taken place.

Conclusions

Purchasing a disk drive is a very important step to upgrading your system. You'll never go back to using cassette, and your software collection will probably grow at an alarmingly faster rate.

For serious use, some of the older drives offer excellent levels of reliability whilst greatly increasing storage space. Beware that IEEE cartridges inevitably destroy some compatibility, however in certain applications that is no consideration.

Personally, I would never do without my trusty 1541. However, the old 4040 is invaluable for backing up disks using our equally old CBM 4032. Many Bulletin Boards are operated successfully using an 8250 or the more recent 1001 drive, which is basically a single drive version of its predecessor.



The Commodore 128

...so powerful, it's 3 computers in 1



It's a productivity computer!

The Commodore 128 will amaze you with its new generation of powerful yet easy to use productivity software. Like 'Jane', which allows you to follow simple symbols instead of typing complicated commands. And because it's so easy to learn, you'll have the 128 working hard in minutes! You get 128K of RAM both 40 and 80 column displays, and 16 colours for graphics.



It's a family and education computer!

Switch to Commodore 64 mode and you can use more than 3,000 software packages proven on the Commodore 64, The World's No. 1 selling computer. That's power – power for studying, word processing, education, home accounts, programming, fun and games and much, much more.



It's an advanced business computer!

The Commodore 128 lets you use software packages like 'Wordstar, dBase II and Supercalc', all in 80 columns. The Commodore 128 gives you all the computing power most businesses will ever need now or in the future.

Power without the price. \$699.

Excelerator Plus - 1541 Compatible Alternative

Sleeker, slimmer and stylish. Boasting greater reliability and its own external power supply for less heat problems, Micro-Accessories Excelerator Plus looks like a hard drive to beat. Andrew Farrell put it through the lab.

I'm always interested to examine a substitute for the 1541. There is so much room for improvement. One such disk drive that is a fair swap is the Excelerator Plus.

Far smaller than a 1541, and substantially lighter, the Plus is a more attractive unit from the start. Housed in a rigid metal casing that's about two thirds as long and four fifths as wide as the old trusty, it's also a lot squarer.

Imagine the actual dark area of the 1541 and you have the height and width of the PLUS. Inside, the circuit board wraps around the drive mechanism. There's no room for a Dolphin DOS, or similar speed up device. Only one of the chips on our review model was socketed.

The drive mechanism is similar to that of the latest 1541, with a swivel door. The disk slot is not spring loaded, and the disk sits well inside the drive. On several occasions I inserted two disks together, as the first was not visible!

A single LED provides an indication of

power, drive in use and errors by displaying either a green, red or flashing red light respectively.

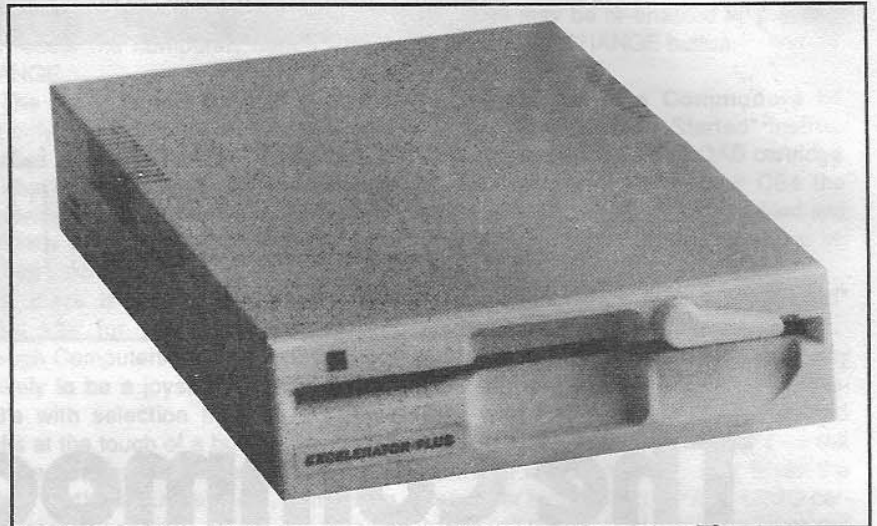

In operation the PLUS is deathly quiet. The familiar drive knock still occurs, but after hours of testing we experienced none of the alignment problems of the 1541. Heat dissipation is not a problem, since this unit has an external power supply that is connected using a din plug. At the back of the unit, there is a rocker switch for power and three din sockets next to each other.

Two provide serial input/output, whilst the last connects the power cable. Underneath the unit is another surprise. Dip switches allow you to select between device 8, 9, 10 or 11. Far

simpler than unscrewing the case of your 1541 and soldering a wire link!

None of the games we tested had trouble loading, but as with all of these types of things, compatibility problems don't normally show their head until further down the line.

Conclusions

At this stage, I could safely recommend the Excelerator PLUS as a viable

alternative for the 1541. It operates smoothly and consistently. For crowded desks, the PLUS has a tight foot print, and a quiet disposition. On the advertisements we are assured that it is faster than a 1541.

During a few simple comparison tests, the only operation in which the PLUS excelled at was formatting a new disk. (See Table). The final crunch is price. Estimates are as low as \$350, so it sure is competitive.

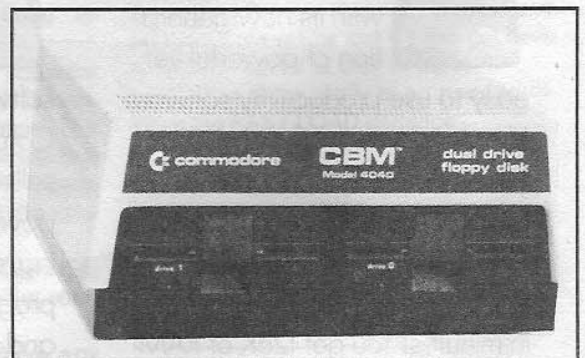

OLIVETTI DM105

- * FULL COLOUR PRINTING ON THE AMIGA
- * USES FABRIC RIBBON
- * NO SPECIAL PAPER NEEDED
- * 115 CPS DRAFT 25 CPS NLQ
- * 3 MILLION CHAR BLACK RIBBON LIFE-2M COLOUR
- * TRACTOR OR FRICTION FEED



AVAILABLE NOW **\$649.00**

SEND SAE FOR FREE SAMPLES



HUGE RANGE OF AMIGA SOFTWARE

0.5 Mb TO 2 Mb MEMORY EXPANSIONS

** FULL 2.5 MEGS FOR UNDER \$1000.00 **

LATEST RELEASES

- * Aegis 3D Videoscape
- * Karate Kid II
- * Express Paint
- * Digi Paint
- * Easy!

CHECK OUR PRICES

- * Instant Music \$69.00
- * Delux Print \$99.00
- * 3.5" Disks \$49.00
- DS DS 3M

**SEND SAE
FOR
CATALOGUE**

LARGE ENVELOPE PLEASE MAIL TO BLACKTOWN

COCKROACH
GRAPHICS
UTILITY



MK. IIIB



**FREEZE FRAME
UTILITIES DISC V2.0**

**DOLPHIN DOS
THE EFFECT IS STAGGERING.**

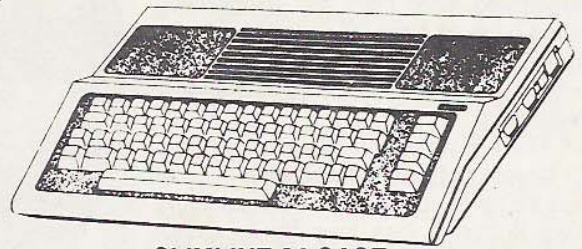

SLIMLINE 64 CASE

COMPUTERSCOPE

PTY LTD

NORTH SYDNEY

TOWER SQUARE
155 MILLER ST,
NORTH SYDNEY.

957 4690

BLACKTOWN

CNR PATRICK ST & KILDARE RD
2/9 PATRICK ST,
BLACKTOWN.

831 1718



ROAD RUNNER

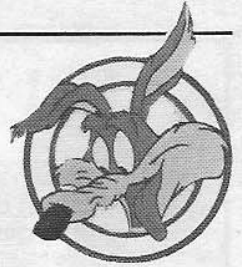

by J. Mark Hunter

THE caption across the front of the package reads, "Cartoon's most elusive character has finally been trapped." And that is indeed front page material. A feat of near impossibility, the greatest challenge known to modern man and coyote. But it gets done this time. Yes, you'll finally see it happen people - the ambush of the *Road Runner*.

Popped up on screen, *Road Runner* quickly became my favourite game for 1987. Just being able to delve back to the happy days of a life when you had time to watch the cartoons, and always time for the sarcastic whims of the supercilious Road Runner.

Well, now they're taking place again on screen, but with you behind the wheel. The opportunity is here to control the mayhem manoeuvres of the desert bird and out-distance the mean-mouthed Wile E. Coyote.

Unfortunately, the Road Runner suddenly looks like becoming an endangered species with a less than fine-tuned precision mind such as a human's directing his step. He never got caught before, but as we learn the new U.S. Gold game, we go through so many trials and errors trying desperately to keep ahead of the hotly-pursuing coyote, that the Road Runner suffers a crucial blow to his outstanding reputation.

There is an opportunity here for Wile E. Coyote to finally get this elusive prize and it's up to you to keep his opportunity from knocking less than thrice, or it's Road Runner burgers tonight!

For a change we're cruising left of the screen, backtracking through the traffic flow and sailing downstream. And they're off to the simulated tunes of the Warner Bros theme track and object number one is to keep ol' Roadie fueled up with strategically deposited birdseed.

With the wolf-type creature rocking hard on his fouled feet it becomes your duty to outmanoeuvre the wolf firstly into the New Mexico desert freeways and into

the traffic. Don't get yourself run over here or you of course lose a life, but if the coyote gets it we're talking an extra half thousand points.

"Cartoon's most elusive character has finally been trapped."

Then it's a class A racing circuit through fabulous twists and bends with a so-sweated chase through the curves it kills you! You think you're just about out of there and BANG! the coyote straddles a rocket and he's turboed himself within his first possible reach. His finger prints are on the Road Runner's tail feathers and ... no, the kid gets away and you're into the next phase ... boulders hurtling

down from an Arizona cliff face and check this one out - the coyote has this souped up pogo stick and you don't know where he's going to be bouncing next! It's a marvellous game!

And it just gets tougher and tougher, folks. Enjoyment absolutely chokes your pleasure chords and being impressed just comes naturally. The antics of the characters, the graphics in dynamic clarity and detail and the changes of tune each phase of the game to even the Lone Ranger rhythm sections is quite a piece of entertainment.

Here's a few things to remember: keep eating the seed. It's quite worthwhile because if you get them all in each phase you get an extra 10,000 bonus points. If you should miss five of the seeds you will faint and also lose a life. Upon eating seed containing iron filings Wile E. Coyote may slow you down by us-

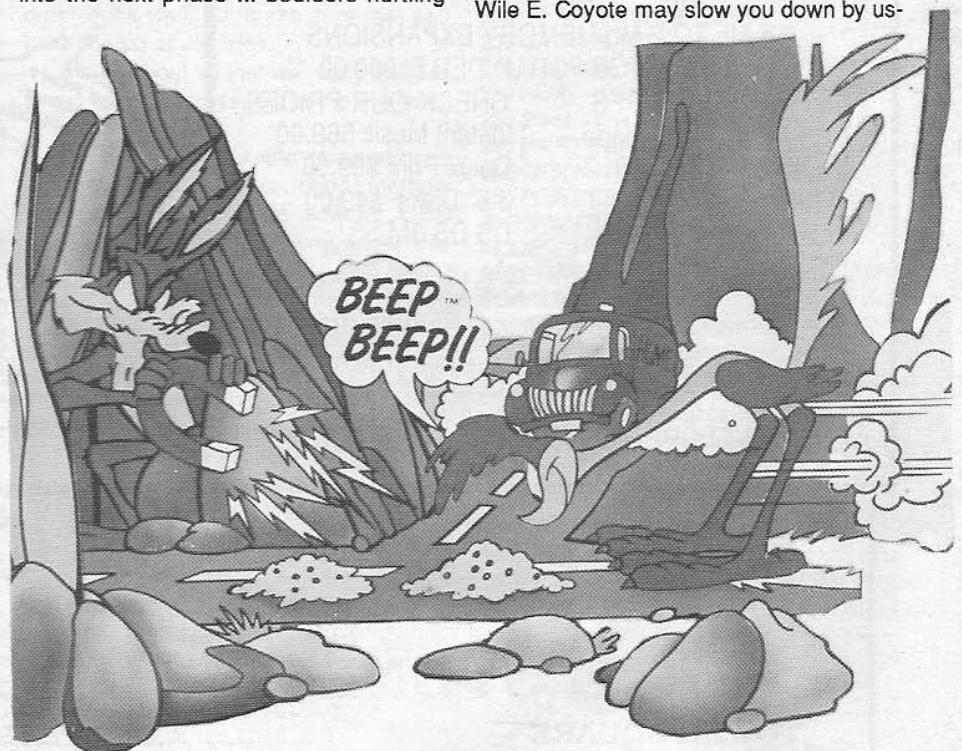

GAME OF THE MONTH

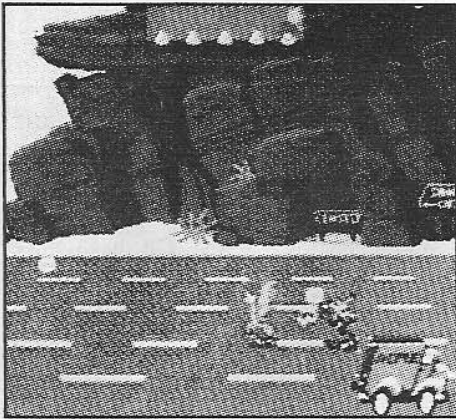

ing his magnet.

Mines will explode if Road Runner or Wile E. Coyote run over them. A bonus is given for jumping the mines or leading Wile E. over them. Road Runner kisses another life away if he suffers the same industrial coma.

Refreshment? If R.R. or the coyote runs over lemonade he/she will stop and drink it. Bonuses are gained if you drink all of the lemonade at the end of the level. You will also score points if either drink the lemonade.

Then, within the manual we come across a heading entitled: "Tongue Bonus." ...we all have our various personal definitions, but the guys at U.S. Gold explain themselves this way, "Take a risk and let Wile E. Coyote move in close to you, then run away and a bonus is scored as Road Runner pokes his tongue out at W.E. Coyote."

Oh.

Boulder avoidance really goes without saying, as does invisible bridging with a leap and a bound, and getting the foxy coyote to miss step on these pathways.

And a major helper is the invisible paint that Road Runner can run across causing his instantaneous disappearance, thereby making him most difficult to ensnare. Ah, but the coyote can do it too, and if that happens, a collision of calamitous desert fauna air space can occur. Everybody loses a life.

All told, *Road Runner* is a totally magic program. The delight that is induced in accomplishing a few phases of this game is worth publishing. They've really done well in perfecting classic manipulations in the program's design, and with the extremely good graphics and colour har-

monized with such an artful creation, you're looking at a very worthwhile investment in your time and wallet depreciation.

If you want the chance to see the cartoon psychopath finally get that smart bird, then hook into this outrageous new program and don't stop until wolf is away from your door!

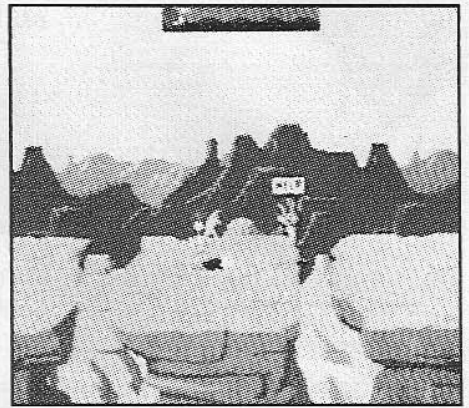

ROAD RUNNER

Publisher	US Gold
Distributor	Ozisoft
Machines	C64
Price	C \$29.95 D \$39.95
Graphics	92
Sound	76
Music	88
Presentation	90
Documentation	94
Overall	96

COMMODORE 64/28 Education Pack

A must for ANY student at high school or University!

MATHS PACK

- * High-Resolution Graph Plotting
- * Numerical integration/differentiation/equation solving
- * Solve simultaneous equations (with up to 40 equations and 40 unknowns)
- * Numerical solution of first order differential equations
- * Least square curve fitting
- * Conic Analysis and much more

ENGLISH/ FRENCH TRANSLATOR

Translate English to French and French to English!

FOR ENTERTAINMENT

- SULTAN'S PALACE**
This is the big one for which the reward was offered (claimed)
- TALKING SAM**
Your friend in the computer
- TANK BATTLE**
- SUBMARINE GRID CHASE**

STAR PACK

A planetary display of the heavens from anywhere on earth

MUSIC MAKER

Play ANY piece of Sheet Music in one to three voices. A good way to learn Music Principal

SCALE YOUR OWN EXAM MARKS

This program will correctly add and scale works to required weights, standard duration and mean

THE ODDS PROGRAM

How to bet on a large number of horses and win a set profit (No Matter What)

SPRITE MAKER

A useful and SIMPLE TO USE little program to create Sprites and multi-sprites and their Data

You get **THE LOT** on one disk for

\$24.95 from

GARY McCLEARY SOFTWARE
P.O. BOX 24, EMU PLAINS, N.S.W., 2750



Eagles...metallic monstrosities of the 29th century.

The year is 2846, not to be mixed up with 2845 when the last intergalactic su-

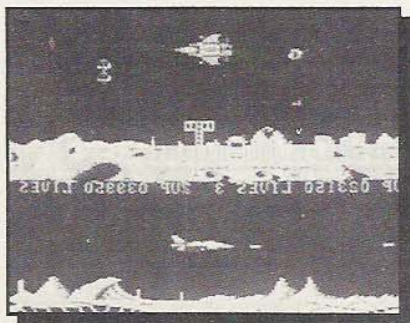

perflight went down, I think about two issues ago now.

The "three hundred year war" rages on, party fever in the dance district. "Having learned their lesson over eight hundred years ago the peoples of the world have universally outlawed nuclear-weapons."

So they've outlawed nukes huh? At least that's something. I wonder what year? They never say. Probably just happened at the beginning of 46 because in 2845 they were still hovering over the button.

But now what's happening in some programmer's undernourished mind is that "genetically created beings" are destroying things, any things. The heroes now, as in yesteryear are the skilled pilots who man the deadly Eagle Fighters flying them against the alien hordes and engaging in dogfights with enemy pilots...good thing they don't dogfight with their buddies!

has ever known." No, not Rambo, the Eagle! With G-Turbo Engine throbbing and blasting into super life! The Xenophoton Cannon and lasers and lots more, just sends that tingle up your spine, don't it just...

Your mission is to destroy all the alien hordes, naturally, and collect the enemy's Message Droids, delivering them to your underground base by dropping them down the pipe located on the planet landscape. As your skill improves and you clear more levels a new weapon becomes available to you—a devastator device. Sounds lethal. Is it? Well, activated, the Devastator Device destroys all planetary

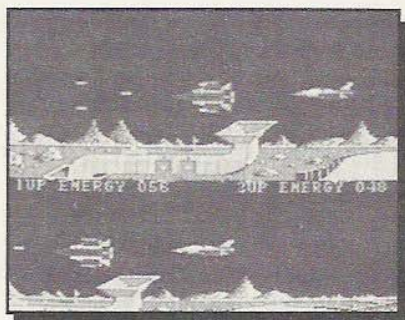

aliens with one flick of the switch. Nuclear Mortein, eh?

Then, when that area is cleared, you move on to battle the Zetafighter. If you defeat Zeta you gain large rewards, bonuses and units of energy. If you lose, well, don't bother hanging onto the key to the executive john, buddy, cause they won't want to see your face around here anymore.

All in all, what we have is some pretty amazing graphics and sensational,

One more very sensational sound. Oh that sound! I'm mindfully blown. The similarity to actual jet engines roaring from a distance then overhead is superb and equated with the most advanced very fancy maneuvering on the ol' joystick. Hewson always comes up with dynamite stuff.

A double screen of colonial-Uridium type landscaping, with hotted up aircraft and edgy, fist-beading play. It's a frantic-dash through the moonbeams and a battle to the computer death. I can't tell you much more, cos this is all I've seen of 2846. But in 1987 *Eagles* is a game worth playing, even if you have to spend money to do it.

EAGLES

Publisher	Hewson
Distributor	Ozisoft
Machines	C64, Amstrad
Price	C \$29.95 A \$39.95
Graphics	82
Sound	93
Music	87
Presentation	74
Documentation	77
Overall	79

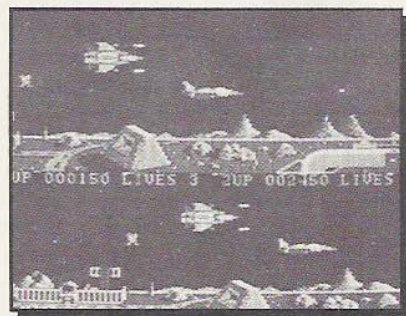

*If you're a Commodore owner - don't miss out
on these great bargains!*

Australian Commodore Review Disk Magazines Nos 1 to 6

Disk Magazine One

Features:

Forest Raiders - Full machine code shoot 'em up
Machine code paint, border, input and flash routines

Nice Lister - for readable listings on
non-Commodore printers.

Recover II - for recovering deleted files,
and a catalog program - for getting a disk directory
without losing your program

And More...

Disk Magazine Two

Features:

Programs demonstrating 3D graphic plots

A terminal program called Teleport

A tutorial on bits and bytes

Character editor - for designing your own
custom alphabets and graphics

A full demonstration of Electronic Card File

And More...

Disk Magazine Three

Programs:

Hangman	Labyrinth
Calendar	Finance
Typing Practice	Roadblock
Bird Invaders	

Features:

Constructabrix - education and graphic
construction program for younger users

And More...

Disk Magazine Four

Special Issue

Featuring:

Graphic Workshop _ a complete design system for
sprites, graphics, and character sets - with tutorials

Also:

Typing Tutor - a complete typing program

Works on errors

Counts your speed

And More...

Disk Magazine Five

Our Biggest seller yet...

Featuring:

Utilities for using Newsroom on an MPS 802 plus
printing disk cover with directories, writing signs,
printing Doodle and Printshop pictures and more all
on the MPS 802!

A demonstration of games in the future

And More...

Disk Magazine Six:

Featuring:

Games:

Bert the Bug

Hangman

Demos:

Amiga Pharoah

Space Harrier

Max Headroom

The Pacer

Sade

Home Inventory

Graphics:

Light Fantastic

Utilities:

1571 Utility

DIR@828

Disk Filer

And More...

Order Form

Name: _____

Address: _____

_____ P/Code: _____

Cheque: ___ Bankcard: ___ AMEX: ___

No: _____

Please send me:

_____ copies Disk Magazine No 1 @ \$10

_____ copies Disk Magazine No 2 @ \$10

_____ copies Disk Magazine No 3 @ \$10

_____ copies Disk Magazine No 4 @ \$10

_____ copies Disk Magazine No 5 @ \$10

_____ copies Disk Magazine No 6 @ \$12

PLUS \$2.00 P+P TOTAL _____

Post to:

Australian Commodore Review

Top Rear, 4 Carrington Road,

Randwick, NSW 2031

OR Use your credit card

(Bankcard or Amex) and call us

on: (02) 398 5111

Please allow two weeks for postage and delivery

XEVIOUS

by J. Mark Hunter

WHY does everything have to happen "eons of time ago"? Tell me that.

Any, "many eons of time ago" an advanced technologically orientated civilization - the sheer creative impromptitude of this program just grips me! - was forced to evacuate the Earth prior to the Ice Age. ... Ahhh, you see, but they were warned, they just didn't listen. Their mothers *told* them to bring their thermal underwear and snow chains and you see what happened, they couldn't stay behind and play out there with the other advanced technologically orientated civilizations...

Now, these Xevious people, affectionately known as "Xeviates", are coming back! Yeah, returning to reclaim their heritage through conquest. They've got their underwear, they've got the chains, they've got the space ship anti-freeze. From the controls of your Solvalu super spacecraft you must defend the Earth from takeover by the Xevious invaders!

How ya gonna do that?! Just pray they touch down in Siberia in winter or Melbourne in summer. Fly a search and destroy mission, cruise over scrolling landscape, bomb Xevious ground estab-

doing your make-up in one of those, babe! Flying mirrors, impossible to destroy, "a collision will spell certain death" (in twelve letters or less).

In the event of your surviving wave after wave of enemy onslaughts you will encounter the controlling force of the Xevious offensive - the Andor Genesis Mother Ship! This is your goal.

A direct hit to her central reactor will disable her, but don't be lulled into a false sense of security, you didn't hid the chip in the Ming vase that well. Xevious forces will soon reappear to renew their attacks with increased determination! One more exclamation mark - !Oooh, and another !! I like it.

And after all this serious flippancy it kind of may come as a shock to all but I didn't think the game was that bad. In fact, move your eyes to the bottom of the review and have a scrute of the "Overall" figure - better than three quarters of the way towards perfection, excellence, 76.

Xevious on your homestead computer is a good implementation of the arcade game. And even though computer magazine writers love using the word "implementation" I give you not. Good implementation, but it does get sluggish on the manipulative qualities. Moving in for a quick shot doesn't come with V8 assurance nor turboed ease, because you don't find out what you've got under the hood (or what you don't have under the hood) until it's too late, and

the sound effects of the explosion turn out to be you...to be you...to be you...to be...

Graphics are feasible, some kind of lilypad green houndstooth pattern representing what we must take for alien vegetation - the actual craft not exactly streamlined supersonic either, but it has the ammo and the wherewithall to maintain a dignified front on the battlefield.

In relation to the arcade version as opposed to the one you've got flashing late, late movie patterns on your bedroom wall - the PC Xevious definitely lacks, not in everything, but you've got more of an edge to win when you had to insert \$0.20...where am I?- 40 cents in some suburban shopping mall machine.

Music sounds like a cockroach gargling with eggnog and bugs you very, very soon.

According to my main man Farrell: frustration is a key doom factor. The explosion sequences just don't make it. Yet, yet, it's still quite stimulating, even though they haven't made it just that tough enough to quell the perturbable hours of your time with the same stealth as a Ludlum novel.

See you next month, or maybe tomorrow morning on the train. I take the 8:08 to Mars.

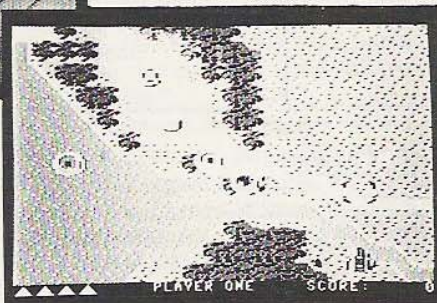
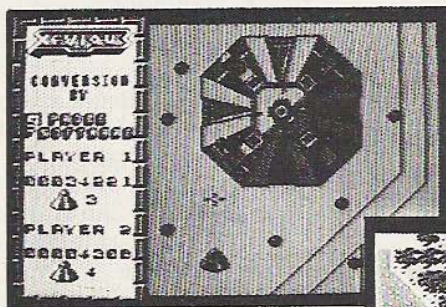

lishments and zap air targets.

So we're cruisin' now, we're searchin' and bringing the searches to sudden ends now, we're bombin' and zappin', is it rude of me to ask if there's more? ... Oh, there is! Wait for it! "FLYING MIRRORS!" Yeah, try

XEVIOUS

Publisher	Namco
Distributor	Melbourne House
Machines	C64, Amstrad
Price	C \$29.95 A \$29.95
Graphics	74
Sound	76
Music	40
Presentation	81
Documentation	55
Overall	76

ANNOUNCING

FOR ONE MONTH ONLY

The Pactronics **\$99** Winter Sale

Warm up with these fantastic Add-ons to your C64

THE FINAL CARTRIDGE: with free "Lockpick" and Voicemaster Demo Disk
— *the final solution to all your extra requirements for your C64*
Allows you to write to an extra 24K of memory : Disk turbo (3.5 times faster) :
Cassette turbo (7-10 times faster) : "Tool Kit" commands (Auto, Renum, Old,
Help) : New simplified DOS commands : Additional BASIC commands : Pre-
defined function keys : Centronics interface (allows non-Commodore printers
to print graphics) : Hi-res, Lo-res and Multicolour mode, full page screen
dumps : Machine language monitor, assembler and disassembler.
**** THIS IS NOT A FREEZER**



VOICEMASTER
— *The ultimate human to computer interface*
Your computer talks to you in your own voice
Your computer responds to your spoken commands
You can write songs and music just by whistling or humming
You can play games by spoken commands



MAGIC MOUSE
— *This is a true Mouse with its own graphics software*
Includes the following:
* Hi-Res Drawing Program
* Mouse Driven Software
* Icon Designer
* Sprite Designer



AND A SPECIAL "SPECIAL" AT ONLY \$29.00

Rest your eyes with the Pactronics Screen Magnifier
* Increase picture size by up to 50%
* Ideal for 80 column work for fine graphics
* Can be free standing or supported by monitor



Available from Grace Bros, Chandlers, Maxwells Office Supplies, and from computer re-
tailers around Australia. Mail Order - "Software To Go" - (02) 457 8289

FOR THE NEAREST RETAILER IN YOUR STATE CONTACT:

N.S.W.: Pactronics Pty Ltd, 33-35 Alleyne Street, Chatswood. (02) 407 0261

VICTORIA: Pactronics Pty Ltd, 51-55 Johnston Street, Fitzroy. (03) 417 1022

QUEENSLAND: C.S.Q. Electronics, 66 Abbotsford Road, Mayne. (07) 52 9633

SOUTH AUSTRALIA: Baringa Pty Ltd, (08) 271 1066 ext. 6132

WESTERN AUSTRALIA: Pactronics W.A. (09) 332 3807



FLYSPY

"LONG, long time ago...in a galaxy far, far away...something about warped geniuses, nasty professors, wreaking of vengeance, etc. Infiltration into the National Grid control system, power cuts country-wide, it's all here. And it, this guy, must be stopped.

Oh, sure. And how do we make this happen? Me, probably. Am I right? The player's got to do it? Certainly so. How? Got to get inside, inside the proverbial super-computer controlled by what's—his—face, the jerk, the real bad jerka-mundo.

They get you shrinking in size, micro-chip shoulder pads and assorted silicon underwear. Then you're riding a micro-chopper with the whirly-bird thing on top and hazard lights jammed on. Equipped with a small fuel tank and a special, limited-edition, customized shield unit. A suave runabout with standard equipment interface enabling you to attach to the chopper any equipment left lying about

the place.

Inside this computer where no one else this side of Andrew Farrell has ever trekked are several teleports located at suitable intervals and you can use these to jump short distances and save yourself a lot of time and fuel. Then there's matters about keys and teleport codes, standard computer-innard-crawl data you always get with these things.

The music is hardly inspirational. Sounds like a dying tulip actually, sounds like a hi-fi in a Fanta can.

Graphics are highlighted by the significantly good colour, but the sound effects replicate the playback on an answering service.

The chopper is fun and the arcade and alleys you zip your way through prove quite a saturation level of amusement and enjoyment. At least we're somewhere else on Earth having this adventure. Nothing more than a few feet off the ground, nowhere where Skylab could scratch our paintwork.

We're inside the computer! And the only war happening is on the outside, beyond the screen - where flies and spies deserve each other.

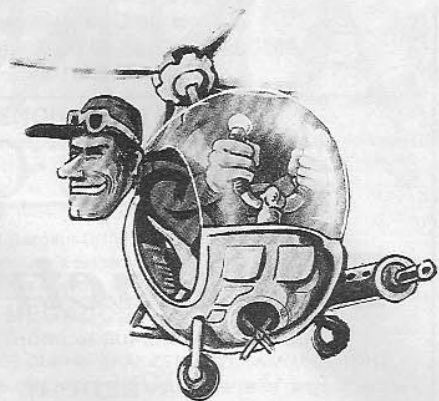

FLY SPY

Publisher	Mastertronic
Distributor	ISD
Machines	C64
Price	\$9.98
Graphics	78
Sound	55
Music	47
Presentation	48
Documentation	65
Overall	70

TRAP

Trap scenario ... Time — an age in which the ultimate deterrent may have become the ultimate destruction. Are we talking syphilis here, traffic fines and blimp joy rides?

The place: A distant corner of the galaxy where you can't find anything, where human life strains to exist in the void of space.

Setting: Brisbane. It's true. I mean it gets better than that in Soweto.

The mission: "Can a violent aggression and mindless destruction ever be justified in the name of peace?" This is the question we get asked on the cover of *Trap*.

Feeling kind of psychologically stimulated now, religiously tuned, I answer to myself in as concise a soapbox debate as possible... no. I'm sure Gadaffi and Churchill feel and felt the same way.

They tell us about the "enigma" then. The trap in which you are to be placed in is one of energetically defending your planet, your people from a once peaceful ally.

This outer space adventure might

just as well be about any war going down at 10:00 this morning, I mean, what kind of jive are they pumping here?

Or is it just one of those production department psyches that make you inclined to tune yourself to mock-heroism? Whoa.

Your quest: To demonstrate the reactions and skills of a legendary space fighter or to show the genius of a master strategist...and then they say it's not enough. And now I agree, it's not enough — it has never been.

Three tests worked into the program.

1. Maneuvrability and reflexes in the flight through space mines.

2. Courage and intelligence in flight down Zarkab Valley. Zarkab Valley, where no cat lives alive. And we're meaning the cats... the cats are dead.

N.B. This game doesn't have a cat in it.

3. Determination and stealth. On foot in search of ORBS.

Test 1 and 2, have to be completed and all aliens dissipated into laser clouds before landing and proceeding on foot through test 3. The better you are the faster and more furious the challenge. Every successful mission is rewarded by upgrading your ranking and making the

next in a higher rated spacecraft.

Clear? I hope you said no.

Hey, the graphics weren't either. As of this moment they still aren't. They remind me of cheap copy logo stickers for a B grade, low-rent part of town company. The sound effects based on what comes out of an Amstrad speaker adequately fit the sub-standard material arranged on the magnetic plastic. I'm not even sniffing a breeze of originality here and it's messing with my sinuses.

Don't get trapped into this game. I'm asking for a refund and spending my money on double live albums. You get it?

TRAP

Publisher	Alligata Software
Machine	C64
Graphics	38
Sound	34
Music	27
Presentation	25
Documentation	25
Overall	23

Fastest growing Commodore centre in Australia!
Why? . . . Because we offer unmatched customer service -
with full technical backup.

Full Range of
 Popular Commodore
 & Compatible
 Printers In stock:
 Olivetti, Citizen,
 Commodore, Oki and
 Riteman C+

**** SPECIAL ****
AMIGA!

Insider 1 MEG
 internal expansion
 with 10 year backup
 clock.
 759 Fitted!

Call for details on our
 special AMIGA packs ...
 Tailored to suit you.

*** SPECIAL***

Available Now!

Computerscope Hornsby's own Public domain (over 150 disks!) and
 retail/software catalogue disk. Only \$6.00

We carry over 190 AMIGA titles, please call and
 compare our prices to city prices.

New Releases in Stock!

- | | | |
|--------------------|----------------|--------------------|
| * Hollywood Poker | * Roadwar 2000 | * Easy1 Sketch Pad |
| * Guild of Thieves | * Alien Fires | * Space Battle |
| * Swooper | * Bureaucracy | * Ultima III |
| * Money Mentor | * Digiview II | * Demolition |
| | | * Phalanx |



- * Always more than 800 software titles in stock.
- * Also large range of Commodore/AMIGA books and magazines available.
- * New releases for C64.

- | | | |
|----------------------------------|-------------------|----------------------------------|
| * Moebius | * Road to Moscow | * Nice Modem II & III |
| * Bombjack 2 | * The Last Ninja | * Cartridge Expansion |
| * Auto Duel | * Ultima I | * User Port Expansion |
| * Defender of the Crown | * The Detective | * Fast Change Cartridge |
| * Nemesis | * World Tour Golf | * Adventure - Hint Books |
| * Famous World Class Leaderboard | * Barbarian | * Full Range of GEOS Accessories |

MICRO ACCESSORIES NSW DEALER

**IN
 STOCK
 NOW!**

- | | |
|--------------------------------|-------------------------------|
| * Dolphin DOS | * Quickdisc + Mark II |
| * Slimline 64 Replacement Case | * Freeze Frame Utilities Disc |
| * The Freeze Machine | * Disc Disector V5.0 |
| * Graphics Utility Cartridge | * Dolphin Copy |
| | * Double Image Copier |

*** FREE**
Mail Order Catalogue

Order yours now!
 Send S.A.E.
 (Business type please.)

COMPUTERSCOPE

477 6886 - HORNSBY - 477 7098



Authorized Commodore Dealer and Educational Centre

Address: Shop 35F Hunter St, Westfield Shopping Town, Hornsby, NSW 2077
 2 Doors Down from McDonalds

Micro Accessories of S.A.

ALWAYS A STEP AHEAD

What

FREEZE MACHINE

can do for you
NOW WITH "SINGLE PART SAVE"

- **Freeze...**
Totally unstoppable Freeze facility from the originators.
- **Fast Save...**
Saves in as little as 15 seconds. Nothing else can match this.
- **Multiple Save...**
Make as many saves as you want once frozen, in different styles if you wish.

- **Ultra Compact...**
The most efficient compacter? Our tests indicate this, as many as 5-6 games per disk.
- **Game Killer...**
Incorporates an effective routine to disable collision detection.
- **Independent...**
Even produces stand-alone Lazer files that reload in as little as 10 seconds.

- **Ease of use...**
Always a strong feature, now even more enhanced.
- **Multi-Load...**
Standard cartridge handles many games of this type. With the utility disk, even more!
- **Fast Format...**
Formats your disks in about 12 seconds.
- **File Copier...**
Built-in, fast-file copier will handle files up to 248 blocks long and is really easy to use.
- **Two Fastloads...**
A normal disk turbo at 5-7 times normal PLUS the

- astounding Lazer at 20+ times normal... BUILT IN.
- **Selectload...**
Just use cursors to scroll to the program you want to load and press a function key.
- **Reset...**
Built in, so you can enter pokes for more lives etc.
- **Tape Turbo...**
For quick save/reload on tape.

NOW AVAILABLE
\$108.90



Quickdisc+

FAST LOAD PLUS UTILITY CARTRIDGE
After enjoying considerable success since its release we have now made some improvements to "QUICKDISC+" to maintain its position as the best value in the disk "speed up/utility" cartridges.

Fast LOAD (now 5-7 times normal speed). Works with majority of protected software. Can be switched in and out from the keyboard.

Fast SAVE at 7 times normal speed.

Fast Format takes just 20 seconds.

Fast Backup copies an entire disk in four minutes (not protected software).

Very Fast File Copier for selective file copying at HIGH speed. Now handles files up to 248 blocks long.

Improved DOS commands (DOS 5.1) makes for easy use of the disk drive e.g. `^RETURN` will LOAD and display a directory without over-writing BASIC. `SHIFT RUN/STOP` will LOAD "0:" 8,1 etc. Very, very useful.

Incorporates Centronics printer software (user port) with CBM graphics capability (requires user port centronics cable). A RESET switch is fitted.

(We have found this to be "unstoppable", it even preserves the tape buffer).

NO MEMORY IS USED by this cartridge, it is totally "transparent" and uses special switching techniques.

"128" and 1570 compatible in '64 mode.

PLUS MANY MORE USEFUL FEATURES TO MAKE YOUR 1541 FAR MORE FRIENDLY TO OPERATE.

ONLY
\$54.94
NOW EVEN
FASTER



DOLPHIN DOS THE EFFECT IS STAGGERING.

Now established as THE parallel operating system for the 1541 disk drive. Hundreds of satisfied users include business, hobby and full-time programmers including the Gremlin Graphics team. The speed and efficiency is truly unbelievable, it is compatible with the vast majority of commercial software, speeding up both the loading of the program and of SEQ/REL files. (It is brilliant with Superbase, Easyscript, etc.) For non-compatible programs it can be completely switched out. It DOES NOT use a special disk format and your existing disks will be compatible.

FITTING

Fitting involves the insertion of two sub assembly circuit boards, one in the 1541 and one in the '64/'128. These normally just plug in, but on some '64s a small amount of soldering is necessary.

STOP PRESS

Dolphin DOS wins C.C.I. Oscar for best utility of 1986. First ever 100% hardware rating in CompuNet review. Many more software houses now using D. DOS include: Superior, Alligata, Adventure International, Thalamus and Domark.

- SOME OF THE FEATURES
- * 25x FASTER LOADING (PRG FILES)
 - * 12x FASTER SAVING (PRG FILES)
 - * 10x FASTER LOADING (SEQ FILES)
 - * 8x FASTER SAVING (SEQ FILES)
 - * 3x FASTER LOAD/SAVE (REL FILES)
 - * E.G. LOAD 202 BLOCKS IN 5 SECS
 - * EASY AND FAST DOS COMMANDS
 - * USE 40 TRACKS FOR 749 BLOCKS
 - * MONITOR BUILT IN
 - * DRIVES CENTRONICS PRINTER
 - * ENHANCED SCREEN EDITOR
 - * EXTRA BASIC COMMANDS

(These figures do not allow for searching)

ONLY **\$169.00**

Available for CBM 64 or '128 in '64 mode, please specify

Kernal for '128 in '64 mode	\$40
User port expansion card (3 slot)	\$33
Dolphin Copy (Whole disk in 18 secs and lightning fast file copier)	\$33
Dolphin main board for second drive c/w lead	\$149

If you require further information please send SAE for fact sheet

Introducing the New FSD-2

Excelsior + Plus Commodore Compatible Disk Drive

Faster, quieter and more reliable than the 1541 and 1541C. Breakthrough Direct Drive technology. Guaranteed 100% Compatibility. It even enhances GEOS! Full One-Year Warranty.

NOW AVAILABLE
\$364.95



DISK DISECTOR V5.0

Now the FIFTH generation of the country's leading disk back-up/utility package is available. This latest version includes many more "PARAMETERS" to handle the latest highly protected disks. This includes the latest American and English software. Be warned if you want to back up software by Ocean, Gremlin, Hewson, Domark and even U.S. Gold, whose protection schemes are NOT always the same as the American versions, then you MUST have "D.D.". At press date, we are sure NO other advertised product will handle all these, be it American or German.

INCLUDES THE FOLLOWING:

"EVESHAM 3 MINUTE NIBBLER" is the latest version of the infamous "Evesham Nibbler" now boasting even more power and speed.

Copies highly protected disks in 3-4 minutes. Handles the latest types of disk protection completely automatically. This often involves the use of the "PARAMETERS", these add the vital secret code that the highly protected programs check for. (This is the important difference that makes this the best.) At the time of going to press this program copied virtually all the English and American programs available for testing, including the latest in games and business software.

"DUAL DRIVE NIBBLER" allows the use of two drives to make even faster back ups. Incorporates device number change software so no hardware mods necessary.

"EVESHAM 8 MINUTE NIBBLER" still very powerful and has been improved. Copies a few that the three minute version won't.

Many, many other useful utilities are included on the disk, including SELECTIVE MENU MAKER, FAST FORMAT, FAST FILE COPY, NOVATRANS, DISK ORDERLY, DISCMON+, UNSCRATCH, ETC, ETC.

The whole package is menu driven and has its own fast boot system built in for your convenience. Pays for itself the first day you receive it.

ONLY \$54.94

Customers with earlier versions may return them along with a payment of \$25.00 to receive V5.0. Most routines are CBM 128 and 1570/71 compatible in '64 mode.

Cockroach Graphics Utility - Cartridge and Disk ONLY \$75.90

Capture screens from games etc. Edit and modify captured screens. Use graphics from Print Shop (2 or 3 block), Print Master and News Room (direct from Clip Art) in your own creations. Make Print Shop (2 or 3 block) and Print Master graphics from any captured bitmap screen. Print out any captured screen (including sprites) on a variety of popular printers, including the OKIMATE 20 colour printer, 801/803, Epson, Star, BMC/Amust, etc.

Captured screens may be used in the powerful ROACH SHOW. This is the slide show which has extra fast loading without blanking the screen and has programmable display times. Ideal for rolling demos or educational use.

Driver program to allow use of captured screens in your own programs. Bit mapped screens are captured conveniently in KOALA or DOODLE format and may be edited with these programs, or via the Display Editor supplied on disk.

Conversion programs allow use of other drawing programs. Sprites and character sets are saved separately. Captured pictures may be saved in compressed form, for speed and efficient use of disk space, and also to establish a standard for use with the printer routines and the ROACH SHOW.

NOW AVAILABLE CARTRIDGE EXPANDER FOR C64™

QUESTION: What is a Cartridge Expander?

ANSWER: The Cartridge Expander extends the "GAME PORT" on the C64. Console by providing 3 additional cartridge "SLOTS" which will hold 3 of your favourite command modules.

QUESTION: Can I use ATARI or VIC-20 Cartridges in the Cartridge Expander?

ANSWER: NO. The C64 home computer will not operate with cartridges designed for other computers. The Cartridge Expander will not change the capabilities of the C64. You can operate any cartridge from the Cartridge Expander that runs in the console by itself.

QUESTION: Why do I need a Cartridge Expander?

ANSWER: The C64 home computer is made to operate only ONE cartridge at a time, however, there are several command modules that are more frequently used than others. Each time you "change" a cartridge, it causes wear on the connector within the computer, and eventually the connector simply wears out. By using the CARTRIDGE EXPANDER, you can keep your favourite command modules plugged into the Cartridge Expander and select by using a switch rather than "unplugging" the cartridges.

The Cartridge Expander has a built in RESET button which can be used to reset the computer. Normally the computer is reset by turning the power off and on, or by plugging a new command module. The handy built in RESET button saves wear and tear on the console power switch.

ONLY \$69.00

FREEZE FRAME UTILITIES DISC V2.0

Now the first support disk to enhance even more the powers of "Freeze Frame". Included on this disk are many routines to enable the complete transfer to disk of more programs that load extra parts. It is used in conjunction with "Freeze Frame" Mk III and means that virtually all programs of this type can now be handled. The program will be regularly updated when new programs of this type appear. Other useful utilities will be added as necessary. Owners will be able to update their disk for

ONLY \$26.95

ONLY \$14.95

MICRO ACCESSORIES OF S.A. UNIT 8, HEWITSON RD, ELIZABETH WEST
SOUTH AUSTRALIA 5113 Phone (08) 287 0191
Made under licence to EVESHAM MICROS. Manufactured in South Australia
Offer subject to availability

Send Cheque, Postal Order or Credit Card No.
Credit Card orders accepted by phone. Callers welcome
Wide range of goods stocked. Trade enquiries welcome. Plus \$3.00 P&P
DEALER NETWORK AUSTRALIA-WIDE

Uncle Pete's latest

Win a disk full of the latest demos

Hello everybody, this time Uncle Pete's got a crossword puzzle for you, written with the remarkable *Crossword Magic* from Mindscape. It's not an easy puzzle but crossword fans may expend few K's of memory over it.

As a matter of fact, the first correctly completed puzzle which I receive will win its sender a disk full of the latest demo's from Europe.

These feature amazing scrolling messages under, over and through the borders, outstanding music and vivid hi-res screens. They are the products of twisted-minded hackers throughout Europe, who are locked

away in their bedrooms for four months of winter with only their 64's for company, and they download these masterpieces through the telephone system to anyone who cares to view them.

I view them as a totally new art-form, of which we are going to see and hear a lot more.

Send your puzzle or copy to
 P.O. Box 4
 West Wallsend,
 N.S.W. 2286

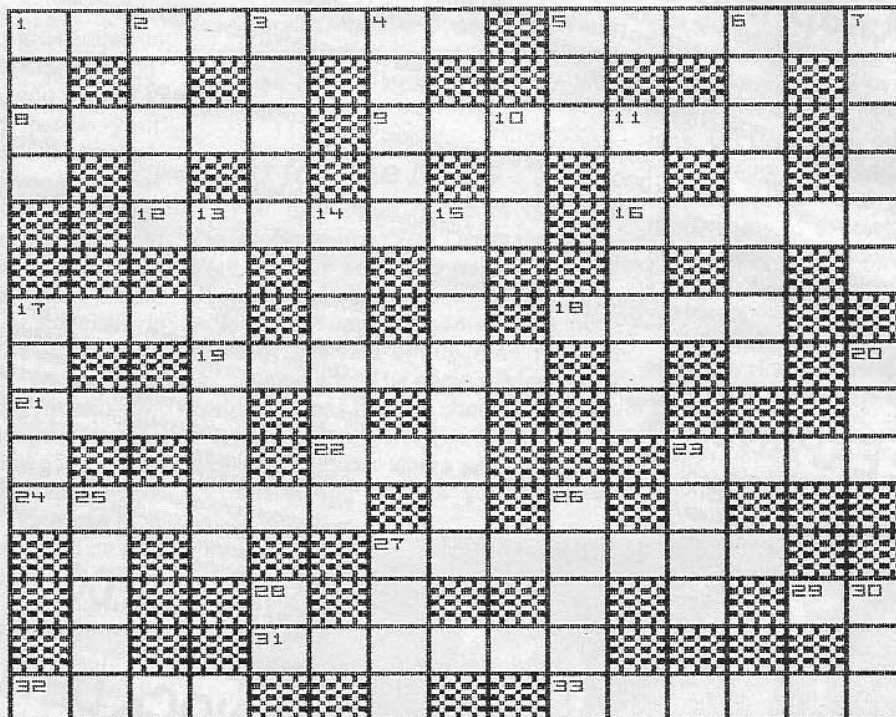

ACROSS CLUES

- 1. Boulderdash hero
- 5.Bovver
- 8. Keyboard code
- 9. Not in gear
- 12. Inputting software
- 16. Newcastle express train and old time pilot
- 17. No. of fingers
- 18. Music interface
- 19. Music style
- 21. Bread unit
- 22. Famous cube
- 23. To read a program
- 24. *Law Of The West* has one
- 27. Fixing errors
- 29. Where its ..
- 31. Eight legged
- 32. Eight bits
- 33. Common error

DOWN CLUES

- 1. Scan pages
- 2. Man's name
- 3. My Friend (TV show)
- 4. Famous Indian cricketer
- 5. Weather in summer
- 6. She-Demon
- 7. Come back
- 10. Caveman's name
- 11. Untrustworthy character
- 13. Too full error
- 14. Old time soldier
- 15. Early fast-loader
- 17. Storage system
- 20. Smallest computer unit
- 23. Having length
- 25. Yarra up for storage (anag)
- 26. In the sky
- 27. Out
- 28. We
- 30. Income...

Australian
Amiga Review

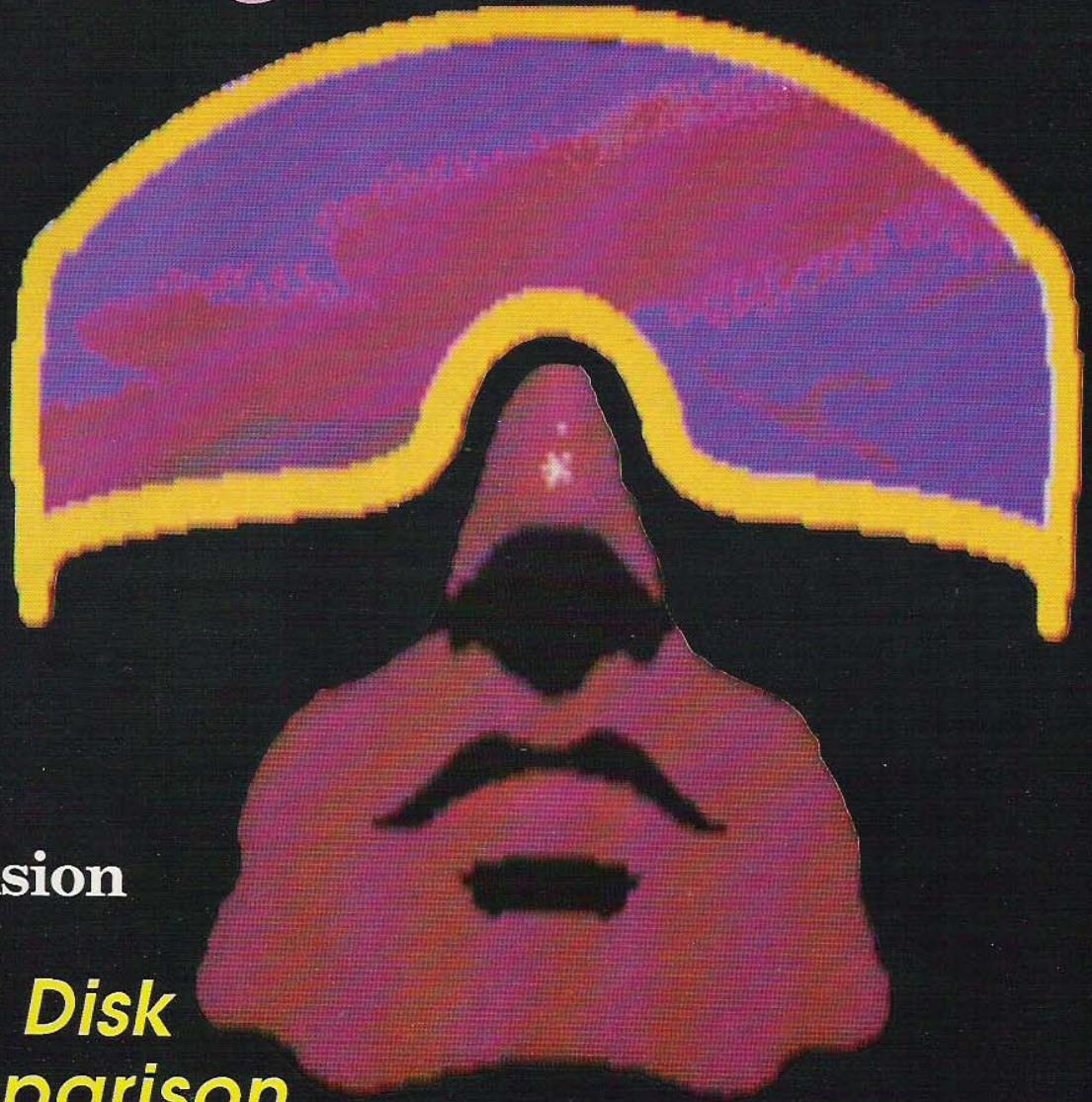

**RAM
Expansion**

**Hard Disk
Comparison**

Telecomputing

Game Reviews:
***Starglider**
***Barbarian**

Using Fish Disks

Vol 1 No 2

Inserted In The Australian Commodore and Amiga Review

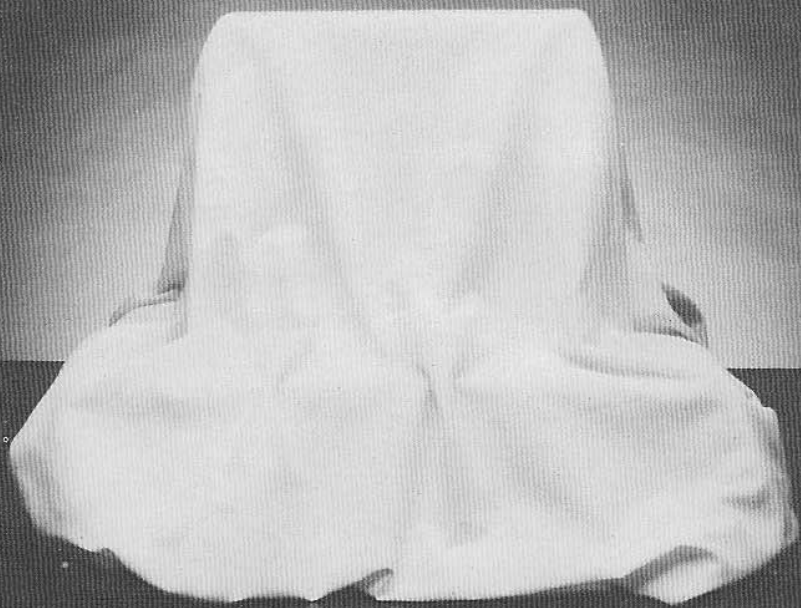

THE WRAPS ARE ABOUT TO COME OFF THE HOME COMPUTER OF THE DECADE

A decade in the computer industry is like a century in any other industry, and conventional PC technology has been overtaken, not by product improvements, but by more advanced technology.

And that new technology has a name: Amiga.

Soon, all the advanced features of the Amiga will be available to the computer buff for less than \$1000 in the Amiga 500.

Here are the features:

- 512K usable RAM for increased productivity.
- Internally expandable to 1 Megabyte for advanced applications.
- Superior GRAPHICS, SOUND & ANIMATION capabilities.
- Multi-tasking for running different applications simultaneously.
- Palette of 4096 colours.
- 4 Channel stereo sound.
- Music and voice synthesiser built-in.
- Large range of software available (over 500 commercially released packages).
- Compatible with all commercially released AMIGA 1000 software.



ARE YOU KEEPING UP WITH THE COMMODORE AMIGA 500?

AMIGA OWNERS

At last, a Major business software breakthrough.

MAJOR Business Software has been designed and developed by Multisoft, in Australia, to satisfy the needs of Australian Business.

After seven years of development on larger computers MAJOR is now available for your Commodore Amiga.

MAJOR will increase your office efficiency by providing a formalised accounting and recording system. But MAJOR does more than just keep records — MAJOR is the key to managing your business by providing more information, more quickly and more accurately.

THE SIMPLICITY OF MAJOR BUSINESS SOFTWARE

MAJOR is menu driven and easy to understand. Prompts guide you every bit of the way — and just to make sure, each MAJOR module comes with one of the most comprehensive manuals available.

Test data is also provided so you can familiarise yourself with the system before starting to enter your own information.

MODULARISED BUSINESS SOFTWARE

As MAJOR is in modules you need select only those necessary for your business. You can start with the General Ledger then add additional modules as your business grows ... and even an additional terminal.

Modules include:

- General Ledger
- Job Costing — Project Costing
- Accounts Receivable — Debtors
- Accounts Payable — Creditors
- Payroll

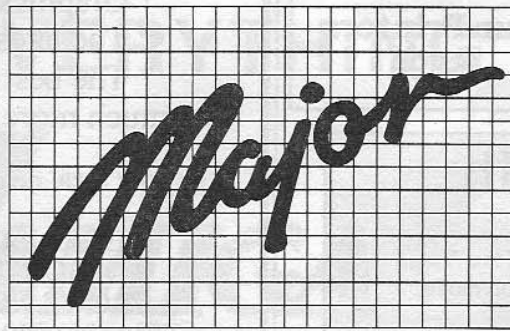

BUSINESS SOFTWARE

- Inventory Control
- Order Entry
- Purchase Ordering
- Asset Register
- Multi-user Amiga*

FULLY INTEGRATED BUSINESS SOFTWARE

MAJOR is fully integrated — all the modules you choose will work together. For example, when you receive an item of Inventory and

enter it into MAJOR, the Purchase Ordering system, Accounts Payable details and General Ledger are all updated — immediately and automatically. With MAJOR you only need to enter information once and all of your accounting system will always be up to date.

MAJOR Business Software is available for your Commodore Amiga 500, 1000 and 2000 with hard disk drive.

For more information, ask your Amiga dealer now.



* Available Sept. '87.

1133 Hay St, West Perth
W.A. PH: (09) 322 6637
Fax: (09) 481 4060

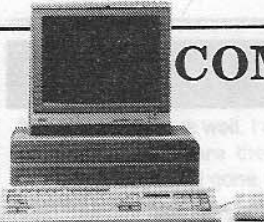

COMPUTER VIEW

21 Brisbane Road
Bundamba., QLD, 4304
Phone: (07) 282 6233
Fax: (07) 816 1221



Computer Retail

Hardware & Software

- Amiga 500 ● Amiga 1000 ● Amiga 2000
- PC10/20 (IBM Compatibles)
- Commodore 64/128
- * One of the largest ranges in Australia
- * The Ideal One Stop Computer Shop



Computer Training Centre

- IBM ● Amiga ● Commodore 64/128



Computer Repair Centre



Public Domain Software Libraries

- IBM ● Amiga ● Commodore 64/128



Print 'N' Wear

- Refer last month's issue for review on how to computer design your own iron-ons



Okimate 20 Colour Printers

For Commodore 64/128 **\$399**

Next Month

★ AMIGA 2000

—A full report on the most expandable of the Amiga range, including a look at the PC emulation mode.

★ Entertainment software

—A complete roundup of what's around when it comes to having fun.

★ Kurta Graphic Tablet

—Instead of a mouse, use a graphic tablet. Full review of one of the less expensive models.

★ Letters

—Send in a query today so we can publish it soon, complete with answer of course.

★ Amiga Talker

—A word processor that talks! How good is it? Staff writer, Mark Hunter, puts it through its paces.

★ Coming Soon ★

—Memory expansion. From several kilobytes to multiple megabytes. A full comparison test of all the options and choices.

—Are you a distributor of one of these devices? Contact the editor as soon as possible to be sure your product is included.

MASTER YOUR AMIGA WITH

THE MAGAZINE-ON-A-DISC

MEGADISC

Numbers 1 and 2 and **3**
AVAILABLE NOW!

You'll get:

- * Indispensable information
- * How-to articles
- * Free utilities
- * Reviews
- * Graphics and DeskTop Video
- * The latest from overseas
- * The best of Public Domain and much more.

Ask your local dealer or order direct from:

MEGADISC DIGITAL PUBLISHING
P.O. BOX 759
CROWS NEST 2065.
TEL: (02) 959 3692 or (02) 436 4659

ENQUIRE about subscriptions (\$90 for six issues), the Public Domain catalogue on disc and Public Domain discs (\$8.50 each), as well as special compilations on specific themes.

Ask about our Amiga Training Courses tailored to your specific needs with FREE PD software included in the training!

Send cheque or money order with your order for immediate delivery.

★ Get Megadisc 1, 2 & 3
for \$50

Editorial

Welcome to the second issue of *Australian Amiga Review*.

Your copy, if not inserted in the middle of *Australian Commodore Review*, was sent to you with the compliments of one of the following dealers:

In Victoria by **High Technology**

In N.S.W. by **United Computers of Sydney**,

In Western Australia by **Bruining Headlam**,

In Queensland by **Brisbane United, Scarborough Fair and Computer View**.

Australian Amiga Review is produced monthly, to provide users with a guide to specific products and applications.

If you have any questions you would like answered, or topics you think we should write about, please don't hesitate to contact us by mail.

Contributors are also welcomed. At the moment we have limited space available, but we fit in as much editorial as possible in every issue.

The Amiga has managed to establish itself as a market leader in Australia. With three models to choose from, all offering vast potential, the future looks exciting.

At the moment we are testing out the new Amiga 2000, with bridge board and expansion memory. It looks to be the ultimate choice in home computers. You can have the power of Amiga's graphics, sound and multi tasking capabilities as well as the flexibility of PC compatibility. Full report next month.

Until then, remember not to pull the disk out until the light goes off.

Andrew Farrell

Amiga Today
Top Rear, 4 Carrington
Road,
Randwick, NSW 2031
(02) 398 5111
Published by:
Saturday Magazine Pty Ltd.
Editor:
Andrew Farrell

Publisher:
Gareth Powell
Advertising:
Ken Longshaw
(02) 398 5111
Production:
Brenda Powell
Layout :
Amanda Selden

**Subscriptions & Back
Issues:**
Tristan Mason (02) 398 5111
Distribution:
Selected dealers
and as part of *Australian
Commodore Review*
Printed By:
Ian Liddell Pty Ltd

Directory of Advertisers

Acme Software IBC
Bruining Headlam 14
Commodore Business Machines IFC
Computer View 2
Diskworks 7
Expansion Systems OBC
High Technology 13
Megadisk 2
Multisoft 2 & 5
Sydney United Computers 9 & 12
United Computers, Queensland 15

Contents

4. Amiga Hard Drive Alternatives

— Andrew Farrell takes a closer look at what's available on the hard drive market.

6. News, Reviews, Hints and Tips

- 2 Meg RAM expansion/board
- Telecommunications with modems
- The Bit Blitzer 12E
- Using the Fish Disks

11. Amiga at Work - PHASAR

— Review of a new home accounting system.

12. Congratulations Sydney United Computers

— Sydney United Computers are changing their image.

13. Desktop publishing - the High Tech way

— The Amiga enters the desktop publishing stakes

14. Specialised uses for the Amiga

— Bruining Headlam involved in specialised uses for the Amiga

15. United Computers Queensland are looking good

— Customer support and new training centres at United Computer Group of Queensland

16. Game Reviews

Barbarian

— Release your built up aggression on the nasties in this underworld!

Starglider

— One of the most professional pieces of software on the market today.

Amiga hard-drive alternatives

by Andrew Farrell

Once you've been treated to the delights of hard disk power, you'll never think in terms of floppies again. This month we take a closer look at what's available.

Four units graced the stage for a line up of the meanest, toughest, collection of drives you've ever seen. All look like they're built to take it. Strong metal casing with chunky rubber feet give sturdy look and feel.

Of course, hard disks are inherently fragile and best treated with the utmost care and respect.

Connections:

All but one of our test drives connected via some form of controller or interface to the bus expansion port. The Multisoft Fast Drive 100 is unique in that it plugs directly into the parallel printer port.

Disk mechanisms used are standard, readily available and serviceable units. Usually the controller used conforms to the SCSI (Small Computer System Interface - pronounced "suzzi") standard. Abiding by this standard is one way of ensuring future compatibility, as the SCSI way is likely to become increasingly popular.

If you already have a device connected to the bus expansion, such as a RAM expander, you'll connect the disk controller or adaptor to the bus pass-through.

Failing that, connect the disk interface first, and your original device second. Try not to get caught with two non-pass through expansion devices. A few of the earlier Amigas had some problems supporting two devices on the expansion bus. Although unlikely, contact Commodore if you should discover this problem.

The Fast Drive 100, although connecting to the parallel printer port, allows up to seven drives to be daisy chained, as well as having a printer connected.

Performance:

Everyone wants the best for the least possible. When it comes to performance, a small tradeoff in price may not be worth the drop in

speed. No single test is really conclusive, as close examination of our results will show. Some drives excel in one area, but fall way behind in others.

Our results were generated using a program that is commonly available in the public domain on Fish Disk number 48. The program performs a series of tests, from writing and reading blocks of data, to multiple file creations and deletions, and directory scans.

Files are then written to the disk in four different sizes from 512 bytes, to 32K, several times. Each file is then read several times and a speed in bytes per second calculated for each function.

No drive is exceptionally fast in every activity. Some show a marked edge over the rest. However, on the whole all perform well. Any hard disk is a welcome relief over the slowness of the Amiga's floppy disk system. Unfortunately, the improvement is not dramatic, with an increased speed factor of only around 3-5 times. This is still way below what some users may have anticipated.

In the future we may well see an increased difference in the

speed of hard disk systems. As DMA development progresses and tighter disk handling routines are written, a further increase by a factor of ten may well be possible.

Rumors also abound of a possible release by Commodore of an improved disk I/O system. Amiga-DOS is inherently slow at present, but operation may be improved with the use of extra memory. Use the ADDBUFFERS command from a CLI to increase the size of the capture area for the last accessed file.

Conclusions:

If you're after a quick and simple solution to disk storage, you'll probably end up buying the Multisoft Fast Drive 100. It is readily available and will work on the entire Amiga range including the Amiga 500 and 2000. However, keeping future developments in mind, it would be wise to take a close look at Expansion Systems hard drive. It's the more pricey of the bunch, but by far the fastest. A cheaper alternative is the C Ltd, which combines good performance with a relatively low price. At present Expansion Systems only have

available the 20Meg version of their drive. However, we tested the 80Meg version which uses a Voicecall drive mechanism, the test results of which are those in the included table 1.

Multi-Soft will be releasing an 80 and 40 megabyte version of their drive in the near future. ACME Software are also expecting a new drive in coming months, so stay tuned for further details.

Fast Drive 100

Multisoft
1133 Hat St, West Perth
Phone: (09) 322 6637

C Ltd Hard Drive

ACME Software
PO Box 3, Brighton North
Vic 3186
Phone: (03) 596 6732

H-HD/X-1000

Expansion Systems
111 Palmer St
Woolloomooloo, NSW 2011
Phone: (02) 356 3445

Table 1.
Fish Disk Tests
Written By Rick Spanbauer.
File read and write measurements are in bytes per second.

Device	DF1:	RAM:	C Ltd.	Fast Drive	Expan. Systems
File Creations	0.1	5	6	7	6
File Deletions	1	10	10	15	15
Directory Scan	36	5	51	39	51
Seek / Read	17	51	55	33	53
Read 512 bytes	11702	201469	28807	15791	26214
Write 512 bytes	4818	131072	12977	9295	13443
Read 4096 bytes	12365	655360	34952	18591	19134
Write 4096 bytes	4974	262144	17712	9602	13512
Read 8192 bytes	12423	873813	34952	18724	22405
Write 8192 bytes	4955	262144	17712	9637	13512
Read 32768 bytes	12483	873813	34952	18995	23405
Write 32768 bytes	4964	291271	18078	9673	13512

Table 2.

Product	Cost	Capacity	Adaptor Price	Pass Thru	DMA Access	Cooling Fan
Fast Drive 100	\$1995	20Meg	n/a	yes	no	no
C Ltd. Hard Drive	\$1895	20Meg	Included	yes	no	no
	\$2900	40Meg				
X-HD	\$1795,	20Meg	\$1395!!	no	yes	yes
	\$2800	80Meg	\$1395!!			

!! X-1000 Multi-Function Board includes battery backed clock/calender, 512K FAST RAM, SCSI interface.

AMIGA OWNERS

Now with Fastdrive 100, you get 20Mb to 40Mb hard disk versatility for Amiga 500, 1000, and 2000 in a single, compact unit.

Designed, manufactured and supported in Australia by Multisoft, Fastdrive 100 links to your Amiga parallel printer port via a 25 pin shielded cable. This leaves the expansion port free for additional memory to be added.

Exclusive Multisoft interface electronics combined with hard disk storage drives from leading manufacturers ensure Fastdrive 100 is not only fast, but reliable.

Put these features together with local backup and Fastdrive 100 represents a breakthrough in mass storage for the Amiga owner.

ADDITIONAL FASTDRIVE 100 FEATURES.

- The vented steel case and power supply are designed to create convection cooling for the drive mechanism, which alleviates the need for cooling fans, and results in extremely quiet, low maintenance system operation.

- Up to seven Fastdrive 100 units can be daisy chained together.

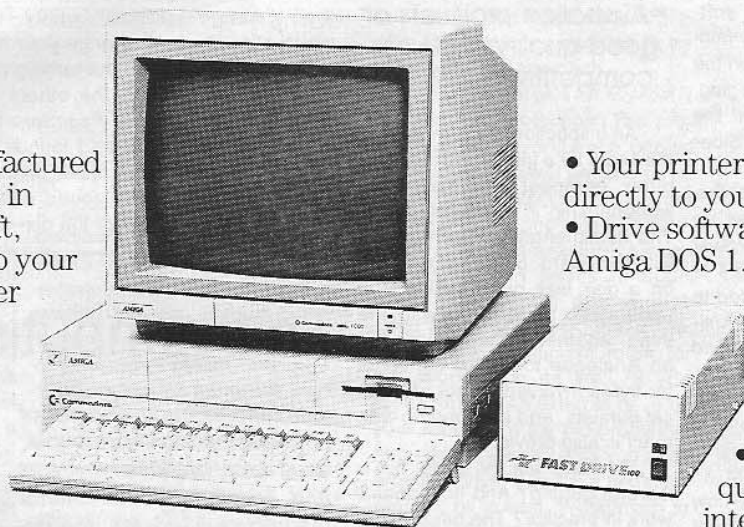

- Your printer can be connected directly to your Fastdrive 100.
- Drive software runs under Amiga DOS 1.2 and easy start up and diagnostic utilities are included to verify and test for correct operation.
- 36 watt high quality reliable internal supply.

Put these features in a colour co-ordinated steelcase designed to match the Amiga unit and you have the revolutionary Fastdrive 100.

See Fastdrive 100 at your Amiga dealer now. Another quality product from Multisoft.

FAST DRIVE 100



1133 Hay St, West Perth.
W.A. PH. (09) 322 6637
Fax: (09) 481 4060

Two Megabyte RAM Expansion

It is a welcome change to be able to review a locally produced product which holds its own against the imported variety - "import substitution" as Mr Keating would have it, and let's hope there's a lot more of it, if only for the improved prices.

Proton Microelectronics is the company responsible, based in Adelaide. Their range of RAM expansion boards includes 512K, 1024K and 2048K versions. The one I have tested is the 2 Meg (or 2048K) and it is a Non-autoconfigure board - I am assured by Proton that their Autoconfigure versions (for 1.2 software only) will be available by mid-to late August, for \$95 extra on the prices they are currently charging. Proton also assures me that the boards are compatible with Sidecar (not having a Sidecar, I couldn't test it), and that the boards are designed to chew up little power due to their "Low Power CMOS Design", thus allowing 4 of their 2 Meg boards to be added to the side expansion port of the Amiga, giving a remarkable 8 Meg and more!

Having had the extra 2 Meg available for the last couple of weeks, it seems hard to imagine finding a use for so much RAM... then again, it is remarkable how memory demands rise to meet availability.

Installing the unit was a simple matter of pushing it into the side expansion port (with power off); copying the two commands ADDMEM and MEMINSTALL into the C directory of the boot disk, and adding the command MEMINSTALL in the startup-sequence in the S directory. Booting up then shows a message saying "some expansion memory found" and it's all available for use. If you happen to have a Sidecar, your startup-sequence will say Meminstall -Sidecar, and if you've had the "Kickstart in ROM" upgrade done, you'll type in -kickram as well. The board also

comes with an optional clock, worth getting so that you can forever forget entering the time and date. Note that all the above will be unnecessary if you buy the Autoconfiguring version - the 1.2 software will handle it all for you.

The appearance of the unit is neat and pretty compact - it is beige-coloured, practically the same as the Amiga, and when sitting in the port rises about 3 cm above the CPU, and extends from behind the joystick port to the back of the CPU. It's housed in a metallic casing, and of course has a Pass-Through Bus connecting up more units.

"Australian products of good quality and very competitive pricing"

An inspection of the innards of the board by a friend who is a computer engineer revealed solid workmanship in the construction. The documentation which comes with the board, both on paper and on a disk was quite sufficient to understand what to do with the thing. Another option provided is an Analogue to Digital converter for those involved in more technical pursuits, and a six month warranty is also provided.

So those are the facts, but is it worth getting? And how does it work in practice? The best use for such a board, in my opinion, is for setting up a "Recoverable RAM Disk" (RRD). The great virtue of such a device is, as its name implies, that if the computer hangs, or you get a Guru, you can reboot with the same boot disk and everything that you had in RAM is still sitting there, blithely unaware of any crash. This makes you feel warm and secure, since you can use the speed of RAM without its transience. So, for example, I load my full customised Workbench into RAM (or the virtual device VDO; to be precise), remove the actual disk and carry on as before with much greater speed, and with a disk drive freed up. And since

the total RAM of the system comes to over 2.5 Meg, there is still about 1.6 Meg available for other uses.

A company called ASDG in the US has made available such a RRD on Fish Disk 58 as shareware, and it works very nicely with the Proton board. Such a set-up would also work with the 1 Meg board with room to spare, and if you got the half-Meg board you would probably make a slimmed down RRD with just the basic commands and libraries.

As noted in the documentation, there are some programs which don't run with Expansion RAM, notably *Deluxe Paint I*, which uses "Chip" memory (your original 512K of RAM) exclusively. Most programs are fully compatible with expansion RAM however and will look for it and use it if it's there.

I noticed that a couple of little utilities had problems, for example the "ChangeKickStart" utility, which allows you to change your Kickstart disk over without turning off the computer. On the other hand, I loaded the entire *PageSetter* program into RAM and found that performance was much improved, especially the speed of refreshing or changing of the dis-

play.

All in all, considering the facts that these are Australian products of good quality and very competitive pricing, and that the addition of more RAM makes your Amiga purr with pleasure and speed, I would recommend these boards highly. If you want a little more ease of installation, wait perhaps for the Autoconfiguring versions. But if you're finding that you're beginning to reach the limits of your 512K fairly regularly, consider such a purchase. The Amiga was made for it, especially since it's a multi-tasking machine, and you'll find quite a leap in performance.

Of course, my problem is that now that I've tried it for review purposes, I can't do without it, and I'll have to fork out and buy it.

Source:

Proton MicroElectronics P/L
Tel: (08) 277 0323

Products:

512K RAM board \$470
1024 K RAM board \$590
2048 K RAM board \$980
Clock \$95 extra
Autoconfigure extra.

Availability:

Some dealers

□

Telecomputing by Tim Strachan

With the huge number of communications protocols, baud rates, brands of modems and computers and claims made by advertisers, the beginner can feel very confused.

All he wants to do is get onto a bulletin board or a database. I'll try to clear up a little of that confusion here, and review a couple of packages which should help.

Overview: Modems are needed to communicate with your computer over the phone lines, simply because computers emit digital pulses (bits and bytes in bursts) while phone lines transmit in the form of a frequency. This will change as voice telephone networks slowly change to digital transmission, when it should be possible to connect a computer directly into the network - but not yet.

Mod/Demod: Keeping it simple, modems take the digital output of a computer and change these signals into an audio frequency, a process known as Modulation. The reverse process, going the other way, is called Demodulation, hence the name Modem. You can get internal, external or cellular modems. To date, for the Amiga, stand-alone external modems are available, and it is possible to get an acoustic coupler, a simpler type of modem which is a linked pair of insulated acoustic sockets that you push your handset into. These are fairly rare these days as modem technology speeds along.

Smart & dumb: As modems go, there are "dumb" modems and "smart" modems. A dumb one requires that you do everything for it, and will probably handle just

DISKWORKS PTY LTD

3/11A Park Road,
St. Leonards, 2065
Ph: (02) 436 2976

FOR THE AMIGA 500/1000/2000
**MONTHLY MAGAZINE
ON A DISK**



PUBLISHED IN THE U.S.A.
Distributed Under License
by DISKWORKS P/L

- *MINIMUM OF 10 READY TO RUN ORIGINAL PROGRAMS PER MONTH
- *A VARIETY OF ARTICLES, TIPS, UTILITIES
- *LATEST INFORMATION ON NEW AMIGA PRODUCTS
- *AVAILABLE HERE THE SAME TIME IT IS RELEASED IN THE U.S.A.

JULY, AUGUST, SEPTEMBER
issues on sale now **\$17.95** each
BECOME A SUBSCRIBER AND SAVE

3 Months	\$39.00
6 Months	\$75.00
12 Months	\$144.00

BACK ISSUES:
August 86 — May 87 **\$13.00**

SPECIAL OFFER! APRIL JUMPDISK

includes superb Blackjack Game
\$5.00 includes P. & P.

WHY WAIT!!

AMIGA WORLD	CURRENT ISSUES direct from the U.S.A.
AMAZING COMPUTING	\$9.50 each

AMIGA PUBLIC DOMAIN

SPECIAL!

Fish Vols. 1-80 Amicus 1-22

\$5.00 per disk

Yes! THIS PRICE INCLUDES 3.5" DISKETTE

Add \$2.00 p. & p. regardless of quantity

(See June and July Jumpdisk for detailed Public Domain list)

3.5" D.S. DISKETTES

NASHUA	\$39.50 a box	1-9 boxes
	\$37.50 a box	10+ boxes
BASF	\$47.50 a box	1-9 boxes
	\$43.50 a box	10+ boxes

3.5" D.S. COLOUR DISKS

BY MAJOR U.S. & JAPANESE MANUFACTURERS

10 colours available

\$43.50 a box

3.5" EXTERNAL DISK DRIVES FOR AMIGA

For Your



Diskworks continues to bring you **HUGE SAVINGS ON MEMORY EXPANSION UNITS**

THE INSIDER — 1 meg internal expansion RAM memory with battery-backed Real Time Clock

1.5 MEG — internal expansion RAM memory with battery-backed RTC, 2.4k of battery-backed static RAM memory, and provision for SCSI interface

MEGABOARD 2 — 2 meg external expansion RAM memory
20 meg **HARD DISK**

Call Diskworks for details

THIS MONTH'S SPECIALS

MOUSE MATS

CLI-MATE

DIGIPAIN

SCULPT 3-D

by author of Juggler

Call Diskworks for prices

Add \$2 p & p all orders. Offer expires 30/9/87

ALL PRICES SUBJECT TO CHANGE. ALL PRODUCTS SUBJECT TO AVAILABILITY

The Bit Blitzer 12E

Things have changed a bit in Modemland, in terms of both quality and cost, and the Bit Blitzer 12E is a very good example of the changes.

The modem itself is a well-packaged, neat unit with a footprint a little smaller than an external disk drive, and less than half the height, and it packs a lot in. Features included:

- V22 (1200 bps) and V21 (300 bps): CCITT standard, ie, Oz
- Bell 212A (1200) and 103 (300): US standard
- Full duplex, ie simultaneous data transmission and reception over a single telephone network connection
- Auto-dial and Auto-answer and Auto-disconnect
- Tone and pulse dialling (which is automatically detected)
- Hayes AT Command Protocol

- Call progress monitoring (ie, tells you if anything goes wrong)
- Loopback for remote diagnostics
- Internal speaker with manual and software volume control
- 8 status and activity indicators (LEDs)

This list of features is pretty impressive at a price of \$349 RRP, and everything does work. No cable is provided with the modem, so you may have to go to a dealer and specify an RS-232 cable with two D25 male plugs.

The documentation consists of a well-written spiral-bound book which, while it's not a communications text book, is sufficiently detailed to let a beginner test and install the modem. It is well set out with an Overview section followed by a step-by-step procedure for installation.

Telecomputing continued

one speed or protocol, and is fine if you have specific needs covered by its capabilities - an acoustic coupler is an example of a dumb modem.

Smart modems have some fancy frills, such as doing things like calling and answering automatically, and are faster, easier to use and have a bit more style. Some may monitor the signal level and take action to compensate for fading lines, or suspend communications if the line is suspect. A really smart modem can choose between tone or pulse dialling or even mix the two for dialling overseas from a pulse-dial PABX, and it will have an error checking system to put intelligible messages up on the screen if there are problems.

The standard by which modems are judged is the Hayes standard, developed as a result of intelligent design and good marketing. There is a set of commands devised by Hayes, each of which begins with the prefix AT, hence you'll often see an ad for a modem claiming "Hayes compatibility" or AT compatibility".

Bauds and bps: Modem speeds are measured in "bauds", which is

essentially the same as "bits per second" or bps. When a computer sends a character out through the serial port, it uses the conventional ASCII code of 8 bits for each character or byte, to which are added a "start" bit (to say that a character is coming) and a "stop" bit (to indicate the end of that character byte). There are variations on this, but that's the basic idea.

So a 300 bps transmission translates to about 30 characters/sec (say about 5 words), thus taking about a minute to transmit a full A4 page of characters. So from the point of view of saving time on the phone lines, 1200 bps will be more economical.

A smart modem will have a selection of baud rates, and if it's really smart will be able to detect the rate of an incoming call and set itself to match.

Telecom's Viatel service uses 1200/75 bps: the host Viatel computer downloads to you at 1200 bps, while you communicate with it at 75, about the speed of a fast typist. If you're interested in Viatel, you'll need a modem and corresponding software to handle these rates. There are Viatel packages for the Amiga: *SuperTex*

At the back of the manual are some other useful sections: Troubleshooting, to let you solve any problem that may occur; Country Specific Information, including a section on Australian conditions; an Appendix with details about the Serial Cable; Appendices on Hayes Command Summaries; and a listing of the ASCII Character codes.

Having followed the Installation procedure, it is possible to change any of the 10 Configuration Switches on the bottom of the modem. These are set at the factory in a way which works with the Amiga with no changes.

Some of these options are "hard" and some "soft", ie, the soft ones can be changed by commands. There is also a Reset command to change all configurations back to the actual switch settings. In other words, you can fine tune the modem as much as you like, using both hardware and software. Once you've set things up for normal use, you'll probably never

change them.

I've tried the modem with a number of Communications Programs, including *Diga!*, an excellent and powerful program by Aegis; *Vt 100*, another powerful Public Domain program, and a number of others, and have had no problems in getting onto bulletin boards, uploading and downloading files, or even using the "Remote" and "Doubletalk" options available in *Diga!* (Doubletalk lets you transfer files to another *Diga!* user while chatting, and Remote allows you to use your Amiga as a kind of BBS, which others can connect up with to use your Amiga at a distance - both very useful).

I'm told by the supplier of the Bit Blitzer that it is possible to get the same modem with Viatel compatibility for about \$495, a desirable option for some. This will be available towards the end of August. There will also be a 2400 baud modem available in the future, but there are no firm dates

in the Public Domain, for example.

Sync/Async: Below 2400 bps, asynchronous communications is used - ie, there is no overall timing control of the communications system. High speed modems are usually synchronous, ie, a crystal-clock timing system keeps both ends in sync to help preserve data integrity. If you want to get really flash, and have a dedicated line, you can move into speeds of 9600 bps and up. At present, however, the upper limit for personal computers is 2400, and that is rare still.

Standards & protocols: CCITT, an agency of the International Telecommunications Union, has set speed standards, giving each method the letter V prefix. The common ones are:

V21 - mostly used for bulletin boards, 300 bps each way.

V22 - 1200 bps each way.

V22 bis - doubles the speed of V22 to 2400.

V 23 transmits at 1200 bps, receives at 75 (Videotex services)

Naturally, the Americans have their own set of standards called Bell standards, requiring a form of analogue modulation, and incompatible with our standards (just as

they have NTSC video signals while we have PAL). Note that it's unnecessary to buy a modem that claims to adhere also to Bell standards - if you're going to call the US, OTC's MIDAS overseas packet-switching network will handle it using the normal CCITT standards.

RS232: About the nearest thing to a universal standard, but with a lot of unstandardised aspects. The RS-232 port on the back of your Amiga can feed (serially, rather than in parallel) your serial printer or modem or numerous other peripherals. The actual physical standard of the connector itself has developed into use of the 25-pin connector known as DB-25. Not all these pins will be connected, and you may find as few as three, or up to 10 or so.

The Amiga has a female port, and you may find you need a "gender-bender" if your modem's cable is the wrong sex. Also read carefully the manual for which pins should or should not be connected. For the enthusiast, investment in a "break-out" box will let you cross-wire plugs at will. The average user should make sure that the modem bought comes with the right cabling - demand it from your dealer. □

SYDNEY UNITED COMPUTERS

YOUR COMPLETE COMPUTER STORE!

Sydney United Computers, the largest Commodore Computer dealers in New South Wales, have some of the best range of software available for the AMIGA with over 250 titles.

We also stock budget software for the C64/128 from the likes of Imagineering, ECP and Ozisoft.

Come in and check out our newest titles.

We have the full range of Commodore Computers too!

*Commodore PC5
Commodore PC10
Commodore PC20
Commodore PC40*

We will add 20 and 30 mb hard disks to the PC5 & PC20 at reasonable prices.

Looking for a special on printers?

We are major retailers of the Microline ML182 IBM/Amiga/C64/128 Printers. And as we are overstocked, the directors have instructed us to clear our stock - so be quick.

Looking for extra memory for your Amiga? We stock memory upgrades, 20 - 80 mb hard disks, SCSI interfaces and more! Come and see us or call. (City store only)

Sydney United Computers:

207 Clarence Street, Sydney NSW 2000

665 Pittwater Road, Dee Why NSW 2099

Phone 29 5088 -City or 981 4455 - Dee Why

Using the Fish disks

The Fish Disks are a wonderful resource for any serious user of Amigas, and Fred Fish should be congratulated for the sterling effort he has made to bring the wide world of Public Domain software and Shareware to all Amiga users, maniacal and moderate, beginners and veterans.

While all the information is there, however, it's not always easy for the average user to access it, due to the fact that use of the CLI (Command Line Interface) is usually required. Fred hasn't opted for a Workbench set-up, except when the programs arrived with icons already set up. So here we'll explain the few necessary procedures for having a good browse of any such disk that comes your way, and it's worth knowing for both fun and learning.

Method: First, it has to be stated that if you don't have an external disk drive you are seriously handicapped for many operations on your Amiga, apart from this one. It is strongly recommended that you get one, for your own sake.

However, if you persist in this

Bit Blitzer 12E continued

of release yet.

In conclusion, I liked the modem so much I bought it. Had to have it. Considering the fact that it has all the features of Smart modems of much higher cost, is well documented, has a very small footprint, and only costs \$349, I can recommend it as a high quality product of very good value for money.

Combine this modem with a powerful software package like *Diga!* and your communications will be a real pleasure, and not as costly as you might expect.

Name: Bit Blitzer 12E

Price: \$349 RRP

Manufacturer: Banksia Information Technology Ltd, 201 Hollywood Commercial House, 3 Old Bailey St, Hong Kong.

Supplier: Mike Boorne Electronics, Eel: (02) 46 3014, (09) 306 2056. Dick Smith Electronics. Some dealers. □

madness, you will need to load various CLI commands into RAM - see the article in Megadisc 2 for details on doing this, and in the following discussion, when reference is made to **df1:** (the external drive), any single drive user should replace it with **df0:**, having loaded RUN, CD, COPY, TYPE, DIR and LIST to RAM.

So you've got your Workbench in **df0:** and **FISHx** in **df1:**. Those with one drive have the Workbench in it.

● To get into the CLI - Double-click on Preferences, and click on the CLI ON in the screen you'll see. Click on SAVE, and now open the SYSTEM drawer, and double-click on the CLI icon. You're now presented with a CLI window with a little 1> at top left. This is your PROMPT and is where you'll see the result of whatever you type, ie, CLI commands.

[Single drivers now need to copy the above commands to RAM, by entering

> copy c/run to ram:

> copy c/cd to ram:

etc for each command. Now when you see any of those commands mentioned below, add RAM: before each one. So instead of entering

> dir you should enter

> ram:dir and your first command, once you've inserted the Fish disk, should be **>ram:cd df0:** which tells the computer to use the CD (change directory) command from RAM, to change the directory to the disk currently in drive **df0:**]

● First you'll want to see a general Directory listing, so enter

> dir [return]

and you'll see the contents of the ROOT directory of your Workbench disc. To do the same for the Fish disk, enter **> dir df1:**

To get a full directory listing on everything on the disk, including the contents of the SUB-DIRECTORIES (those with (dir) after them), enter

> dir df1: opt a [return]

and you'll see it all scroll past, fairly fast. To pause the scrolling at any time, hit the space bar. To continue scrolling, hit any key, such as RETURN. Now you know what's on the disk, at least by name.

● Further delving - Fred Fish always puts a file on his disks which explains briefly what the various programs are about, and you'll see it at the bottom of the directory listing somewhere in the form of **README.listxx** where "xx" is the number of the disk. To read this, enter

> type readme.list36 [return] or whatever number it is. You'll see it all scroll past, so press the space bar to stop it if required.

You might want to print this list for easy reference, so turn your printer on with your Preference settings as you want them, and enter **> type readme.list31 to prt:** and you should see it appear on your printer.

● Now you'd like to see more, and it may be that you have got Fish 36 and you're interested in the "YaBoing" program in the "YaBoing" directory. You want a closer look, so to change your directory, enter

> cd df1:YaBoing

and you'll be presented with the prompt again. To see what's actually in the directory, enter **> dir** and you'd see

POSTER YaBoing

YaBoing.c

Before running the program, you'll probably want to see if there are any instructions on how to do so, anything that might have to be done first, or whatever. So enter

> type poster

and you can read the contents of this text file, which is probably a message from the author when he uploaded the program to a BBS in the States, and might have some bad-taste jokes, or useful information or even a plea to users to support his efforts by sending in \$10. After you've written out the cheque, you'll want to see what this thing is, so you enter

> yaboing since that is the "executable" program, ie, the one that actually does its stuff. The **YaBoing.c** is probably the "source" file, ie, the listing of the program in the C language, and probably beyond you right now, if you're reading this. By now, you should have seen a little "title bar" appear in your screen, so click on it and you should see a cascade of balls all over the screen. (You could have entered **> run YaBoing** at the previous prompt, to use the multitasking abilities of the Amiga, and

to avoid a software error, as happens very occasionally with the PD programs.)

● You've had your fun with **YaBoing**, and want to check out some of the other directories, so enter

> cd : or **> cd /**

the first of which takes you back to the root directory of the disk you're on, the second taking you back "up" the directory tree one level - in this case, since you're only one level down, they both do the same thing. Now you can carry on doing the same sort of procedure with the other directories on the disk. Simple, eh?

● A final note about Suffixes - just as **YaBoing.c** indicates a C source file, and **POSTER** a short note by the author, anything with a ".doc" suffix means, yes, a document, ".bas" a program in Basic, ".fnf" is a little note from Fred Fish, ".exe" an executable program (ie, just enter its name to run it, though most executable programs are a name with no suffix at all), and so forth. And the accompanying documents should be read first, because the program may need "Arguments", ie, further keyboard inputs after the name of the program, telling it something it needs to know, just as you entered **> type readme.list31**, rather than simply "type". And while the PD programs are generally fairly reliable, you may find that occasionally, for some reason or other, the system will "hang" due to a software error or some such. Put it down to experience, and boot up again, and treat that program with some caution.

With this as a start, you can now use the CLI to investigate any disk, and it often repays investigation since there are frequently useful little things hidden in the directories which are invisible on the Workbench, simply because no icon has been attached to them. This is easily done by using the Icon Editor - see the article on Megadisc 2 for an explanation of how to attach icons to anything.

DOSHELPER on Megadisc 1 is a very useful little utility for anyone learning about the CLI (it brings up information on screen for any of the CLI Commands), and you'll probably find some of the CLI articles in Megadisc of use as well.

Have fun fishing... □

Amiga at work

PHASAR

by Ian Preston

If you want to start an Amiga owner off, the best question to ask him (her) is - what is it good for?

People who don't have a computer in the home often ask this question, especially if it's a new model (or name) computer. If you owned an IBM (or clone), people would assume you used it for business or home accounting; if it was a Commodore 64, their natural reaction would be "a games machine". (Although the C64 has far more uses than that). After Apple's recent advertising campaign, they would assume you used your Mac for bench top publishing.

Most Amiga owners would boast that the machine can do anything; faster and better than any other in the price range. Obviously a computer is largely restricted by software availability. So far the software manufacturers have concentrated on the Amiga's power in the sound and graphics areas. There's enough music and drawing software around to satisfy any amateur McCartney or Picasso. The games players are swooning over the snappy effects, but one (significant) area has been sadly ignored - small business and home accounting; and let's face it, any 68000 based computer with 512K of RAM and floppy drives of nearly a Meg each, should make a great business/home accounting machine.

There's a couple of quite reasonable word processors around. Nothing flashy, but soon to be released packages such as *Vizawrite* look very good.

There's been a glut of databases, but none to satisfy a home management environment, let alone a small business. Hopefully this situation is soon to be remedied by the long awaited *Acquisition* from CBM.

Several spreadsheets have been released, but most are hungry for memory and the standard A1000 is hard pressed to do them justice. Besides, the average home computer user has a tendency to shy away from spreadsheets. The burden of setting one up doesn't justify the end product. The average PC user wants a

straightforward, simple, small business/home "number cruncher".

When the editor asked if I was interested in trying out a new small business/home accounting package for the Amiga, I grabbed at the chance.

First impressions of *PHASAR* (Programmed Home Accounting System And Register) were good. The software is nicely presented in a ringbound plastic binder that not only protects the manual but sits well on the shelf. (I hate spending 10 minutes digging for a reference manual to look up a 10 second problem).

"The average PC user wants a simple small business/home number cruncher"

I groaned at the sight of the first page though. *PHASAR* proudly announced that it ran on IBM PC, XT, AT and compatibles, Commodore Amiga and Atari ST. I immediately assumed the worst; that *PHASAR* was yet another piece of software ported from another operating system, limited by that system and not taking advantage of the Amiga's power.

Certainly the manual is written to cover all systems. The concept of menus did not include the "pull-down" style of the Amiga. Another disconcerting statement in the manual was: *"Most of this manual was written by, and all of it was reviewed by, a total computer illiterate."*

The manufacturer seemed to think this would make the manual more usable for us slow learners; I compared it to reading a motor mechanics manual written by someone with no knowledge of engines!

SPECIFICATIONS:

Remembering the old adage "You can't tell a program by its manual", I went to the system's specifications. Here's a brief rundown: *PHASAR* allows up to 39 accounts, 29 income categories and 97 expense categories. Miscellaneous income and expense categories and a cash account are automatically defined. Transfers

may be made between accounts. The maximum number of transactions permitted for any month is 500. Up to 17 sets containing 20 standard transactions may be pre-defined. A data disk is intended to hold one year's worth of data. At the end of the year, *PHASAR* will carry over all unconfirmed transactions to the new data disk.

"Data entry was easy and quick"

The manual is divided into two main sections (other than the intro and index): Tutorial and Reference. The tutorial is based on a fictional husband and wife team who as well as being a motor mechanic and nurse respectively, also run a chicken farm. The concept of having Egbert and Eloise running Egbert's Egg Farm, although humorous, tends to add confusion to a tutorial that at best, can be described as adequate. After spending some time reading the tutorial, the eggs were beginning to scramble; I decided to try the "hands on" approach.

An important plus for *PHASAR* is - no copy protection. The program can be Workbench copied and can be installed on hard drive. There is no Workbench on the *PHASAR* disk and it is not auto-booting. The manufacturer recommends that on drives of 800K plus, the program disk is also used as the data disk; that's fine, but there's insufficient room for the Workbench as well. If you aren't running an external drive on your Amiga, it's the old problem - swap the disk every time you need a printer driver etc. On a two drive system, all is well, Workbench in DF0, *PHASAR* in DF1.

PHASAR loads by the standard double click on the Icon. Once you're in, that's it. No window or screen gadgets, no multitasking.

GOOD POINTS:

Yes, the manufacturer had gone to the trouble of incorporating pull down menus. Once into the program, the HELP key offered help and the ESC key gets you back to the title screen. As well as operating the pull down menus, the mouse can be used in the actual input of data. The right mouse button pulls up an options screen that relates to the area of the program you are currently using, and the left mouse button doubles as the return key. Moving

the mouse places the cursor over the area you wish to work on. All mouse functions are also available on the keyboard.

PHASAR also uses a nice default system. Once the date has been set (it is first read from the Workbench value; if you're like me, that is rarely accurate), the last used date is offered as a default each time a transaction is entered. Cheque numbers are automatically incremented by the software and the next sequential number offered as a default. The account in use is also offered as a default. All in all, data entry is extremely straightforward. Entry errors (no one's perfect) are easily corrected.

I found the program was so well structured that the tutorial tended to hinder rather than help. The index and the Reference section were enough to get me out of trouble. The tutorial was worth a browse but I wouldn't worry if some of it doesn't sink in.

I used the AAUA ledgers as a test case. The transactions for Aug to Nov 86 (incl) were entered (roughly 160 transactions with a turnover of \$9000). We only use one account (cheque) and the ledger is divided into six income and nine expense categories.

"It reconstructed the data files with no loss"

As indicated earlier, the data entry was easy and quick. The 160 entries took a little over an hour (and I'm no speed typist). Entry of the various categories is simplified as each may be abbreviated to the first two letters (eg library is entered as li). After bashing the keys for an hour I decided to see what *PHASAR* had to offer.

Using the options from the "Transactions" menu, you may view/edit all transactions; viewing includes output to printer. This menu also offers the "Confirm with statement" option, designed to allow the user to compare the transactions with a bank statement.

The "Reports" menu offers view/print account and category summaries. The account summary is basically the balance of each account, the category summary is quite a good breakdown of income/expenditure by month. The "Analyse" menu contains budget and loan utilities and the final menu is "Setup" which allows the defining of drive paths and printer driver specifications.

Continued on page 16

Congratulations - Sydney United Computers

Sydney United Computers are changing their image. Gone are the sales staff in multi coloured jumpers, ties and shirts. Soon you'll be seeing a 'new' Sydney United. In line with their continual evaluation of the market, they have decided that a more professional approach is needed. So changes are being made.

The administration staff, already displaying their new dress code, feel that it makes for a more professional feel, with the added bonus of making life much easier not having to decide each morning which clothes to wear. Added to that, they feel they no longer have to worry about getting biro or other stains on their good clothing. Instead they can still look smart in the clothing subsidised by Sydney United Computers.

The sales staff are also eagerly awaiting their outfits. They are to wear blazers with grey trousers, white shirts and black shoes.

Once again this they feel will add to the professional image they are so eager to display.

Expansion

With the influx of Amiga software these days, Sydney United Computers have found it necessary to expand. As they cannot physically expand the stores, they are refurbishing them so as to be able to stock more software. They have at this time over 250 software titles for the Amiga alone.

Commodore IBM PC compatible packages

Due to the success of the new PC5 IBM Clone, Sydney United Computers have decided to put together a package including:

- Commodore PC5,
- Commodore Green Screen
- Able-1 Software
- 30 MB Hard Disk
- Sidekick Software

They will offer it as a complete package only, for a special price.

Achievements

Sydney United Computers staff have achieved quite a few goals over the past few months. In line with Commodore Business Machines sales incentive schemes, Shane Drew has won for himself one of the top prizes being offered. The top of the line VCR by National will find a welcome home, Shane says, as his old one is showing its age.

Phil Lowe, manager of the Dee Why store, has also benefited from a free gift. Imagineering's latest sales incentive scheme has paid dividends for Phil, who has won a trip to Jupiter Casino for four days, all expenses paid.

And last, but not least, Keey and Mary Drew have benefited from yet another sales incentive by Sydney radio station 2CH, and received a free trip to Singapore for two weeks.

Not a bad month at all for the staff at Sydney United Computers.

What's new

The new X1000 Amiga SCSI interface with battery/clock and an extra 512K is finally here. A 20 and 80 MB hard disk is also available for delivery anywhere in Australia.

Sydney United Computers also stock the 20 MB Fast Drive 100 from Multisoft. You should make any enquiries to Bob Drew.

Having trouble keeping backups? Sydney United Computers are now stockists for the revolutionary backup system that saves computer files on A4 paper! Confused? Call in to have a look. Systems available for the Amiga, IBM PC Compatible and Commodore 64/128 computers. Have a file that you have saved on the Amiga and want to read it into your PC? This is one of the many features available to you. Come in today. Available at our City store, 207 Clarence St, Sydney.

LOOK!

SYDNEY UNITED COMPUTERS

the leading



dealers in NSW

We stock everything COMMODORE

- PC 5
- PC 10
- PC 20
- PC 40
- C 64
- C 128
- Amiga 500
- Amiga 1000
- Amiga 2000
- Memory Expansion
- Hard disks
- Monitors
- Commodore, Microline & Star Printers
- Huge range of software

NEW!

Sick and tired of backing up onto disks to find they are so easily corrupted? How about a backup onto A4 paper? Suitable for C64/128, PC compatibles and Amiga

207 Clarence St, Sydney, NSW 2000. Phone (02) 29 5088
665 Pittwater Rd, Dee Why, NSW 2099. Phone (02) 981 4455

DEALERS DEALERS DEALERS DEALERS DEALERS DEALERS DEALERS

Desktop Publishing - the High Tech way

Want to really see your Amiga fly? Then drop in to High Technology Computer Systems, Melbourne's own Amiga Centre. High Tech has just received a shipment of C-Ltd Hard Drives. These units plug onto the bus of your Amiga, and offer dramatic increases in speed, at a reasonable cost.

For a long time the Mac has dominated the Desktop Publishing market. More recently IBM PC compatibles have been making themselves felt, especially with *Ventura.Ventura* is the top quality desktop publishing program from Xerox.

Enter Amiga - well, the Amiga is a late starter in the desktop publishing stakes (especially as it has only been available for about 18 months in Australia), but is set to give the competition a run for its money.

For those new to this area of computing, desktop publishing allows the user to 'compose' a page - newspaper style - on the screen, and then print it out. This allows such items as newsletters, brochures and magazines to be produced more rapidly, better looking and of course at a lower cost than by using manual cut and paste methods. Graphics as well as text can be manipulated, giving these programs real power and practical use. The power of the newer computers (combined with laser printers) has really made desktop publishing an affordable reality.

At the time of writing there are three main desktop publishing programs available for the Amiga - *PageSetter*, *Publisher 1000* and *City Desk*. All three programs provide the power of desk top publishing with graphics and text manipulation. You can take text from your favourite wordprocessor and

combine it with graphics created with *Deluxe Paint* (or any other drawing program) or images captured with *DigiView*.

The three programs handle the application slightly differently, the best for you being a matter of personal preference.

Postscript laser printers are supported by *City Desk* and *Page-Setter* - with the addition of *Laser Script*.

If you want the facility of mixing colour graphics and text in different fonts, without full desktop publishing facilities (such as multi-column), then *ProWrite* is worth a check out. This is a high quality word processor which is very similar to *MacWrite*, but allows you to manipulate and print out in colour!

For those really serious about desktop publishing - the Amiga will turn your head with the soon to be released program - *Professional Page*.

Professional Page offers full power desktop publishing, and in addition to driving dot matrix printers and laser printers, *Professional Page* can also output to a full scale typesetting machine. This means that the Amiga can be used to directly produce high quality brochures, magazines and artwork.

And if that is not enough - *Professional Page* will be the first desktop publishing program designed for colour work. It will produce the colour separations required for printers to produce full colour printing.

To keep up to date on developments in this exciting area of Amiga application, give High Technology a call. They have a free price list, and offer a mail and phone order service.

High Technology is at 290 Bay St, Brighton, Victoria 3186. Phone (03) 596 6211.

TOTAL AMIGA SUPPORT

THE

AMIGA™ CENTRE

500

1000

2000

SALES SOFTWARE ACCESSORIES SERVICE TRAINING

Give us A Call For Our Free Price List



290 BAY STREET, BRIGHTON,
VICTORIA 3186 Phone (03) 596 6211

DEALERS DEALERS DEALERS DEALERS DEALERS DEALERS DEALERS

Specialised uses for the Amiga

Amigas and the CSIRO

Bruining Headlam Computers, one of Australia's oldest and largest Commodore Dealers have been actively involved in the development of specialised uses for Commodore equipment.

One of these areas is in Satellite Image processing. The CSIRO have two departments which are currently using the Amiga. The Amiga has a number of advantages over existing image display systems. Apart from portability, the Amiga offers a means of displaying graphic

information on a relatively inexpensive computer. In many cases it is not possible to display this type of information on machines costing less than \$10,000 (the Amiga costs \$2000).

Bruining Headlam have had to make extensive international enquiries to source some of the material used by CSIRO and have been able to initiate contact between different organisations interested in this area.

The Marine Laboratories in Tasmania (contact Paul Tidesly 002 206 222) are using Amigas in the development of low cost image

systems for commercial fishermen. Temperature information is received from a number of satellites including the NOAA series, pertaining to surface temperatures of the ocean. This provides the viewer with information on warm and cold currents and where they meet in the Ocean. This is where tuna, squid and many other species of fish tend to congregate. Eventually, commercial fishing operations may be able to have an Amiga computer on board displaying information on areas which are being fished at that time.

A spin off from this is the application of Bush Fire Control. The Tasmanian fire department have purchased an Amiga from Bruining Headlam and will use it to display information on vegetation, fire spots and fire breaks.

The Division of Mathematics and Statistics (contact Norm Campbell 09 387 4733) is using the Amiga for analysing Vegetation in farming areas. It is hoped that the system will eventually be used by farmers to display information on paddocks and allow them to accurately manage application of fertilizers etc. to improve the yield of each paddock.

By using Amigas from Bruining Headlam, the cost of processing and displaying the information can be less than 25% of the cost of using conventional systems.

Amigas and the Water Authority of W.A.

Bruining Headlam Computers have also been actively involved in the use of Amiga computers within the Water Authority.

One of the unique features of the Amiga computer is the ability to multi-task. This means that the Amiga is capable of running a number of programs in the one machine simultaneously.

The Authority has decided to use Amigas in remote Alarm sensing applications. There are a number of sites within W.A. including Water Treatment Plants, Sewerage pump houses etc. which cannot be manned 24 hours a day. The Water Authority has installed alarms which call an Amiga at a central site and give it details about what's happened and where. The Amiga can then look after the alarm.

Let's say a pump overheats and switches off. The alarm at the pump house detects this and telephones the Amiga. The alarm tells the Amiga what's happened, the time and where it's calling from. The Amiga then files this on disk and prints out a report. At the same time the Amiga looks up a list in its memory of which staff are available, who is the closest to the site and who is the specialist for the particular fault. The Amiga then instructs another device to call that particular engineer.

Once again, Bruining Headlam have gone all over the world sourcing some of the specialist components for this system. Once the system takes off, it could be used all over Australia in different remote alarm systems.

Full Range of Commodore PCs & Software

AMIGA 500

THE BRUINING HEADLAM AMIGA CENTRE

Customer Bulletin Board

AMIGA 1000 KIT

New

Free Library Access

AMIGA 2000

commodore COMPUTER

PC10

PC20

PC40

New

AT COMPATIBLE

New Software Imports Direct from U.S. Arriving Monthly.

BRUINING HEADLAM
COMPUTERS
PERSONAL BUSINESS EDUCATION

116 Cambridge Street, Leederville, WA. PH: (09) 381 2988

WA's Only Professional Commodore Dealer.

DEALERS DEALERS DEALERS DEALERS DEALERS DEALERS DEALERS

"Well, we are finally ready to go and it looks great !!"

Carol Jones and John Jewell, Directors of the **UNITED COMPUTER GROUP OF QUEENSLAND** are speaking about the final stage of their total three stage plan of customer support, and more specifically about their new training centres.

"Now we can offer our customers not only truly professional sales people in our three stores as we have done over the last four years, plus the service of a fast turn around time from our service centre if something goes wrong with a computer or peripheral, but now we can offer a complete training course on nearly every type of software available," said Carol

Jones. "We cater for all of our computers, from the 64/128 through to the Amiga and of course the business range of the PC compatibles."

"We have three sales centres, and so it was only natural for us to open three training centres," stated John Jewell.

"This way our customers could be looked after by a training centre in their area. We will have courses for the beginner through to the person who wants to have a closer look at a major piece of software before buying.

"For the business that is already computerized and maybe using it for word processing or ac-

counting, and would like to see the benefits of other programs without the expense of buying them first, they could come to a course on say database and its uses. This not only confirms its usefulness, but now someone within the organization has a working knowledge on how to use it," said John.

"We are very excited with the decor, the seating is very comfortable, the colour scheme relaxing, and every one who attends will have a computer of their own to work with. We have highly skilled training staff for our courses with years of experience in this field."

Country clients are not forgotten by the United Computer Group

of Queensland, with mail/telephone orders welcome and a quick turnaround of product.

The three stores have one of the largest ranges of software available in Australia and new titles are arriving daily.

Many clients are joining the Public Domain Software Libraries and taking advantage of the many and varied programs available to them through this facility. The 64/128 Amiga and PC libraries each have a once only membership fee and the customer then has access to hundreds of software programs for business, education and recreation.

FOR EVERYTHING

AUTHORISED

Amiga Dealer
PC Business Systems
Education Dealer

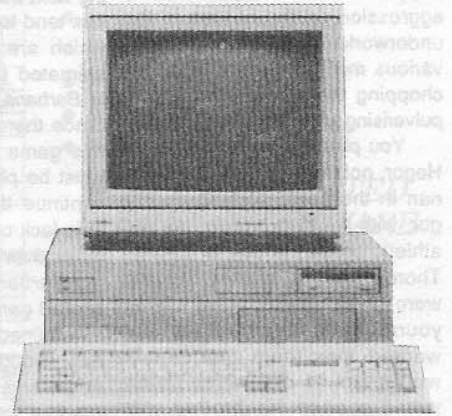

— YOUR QUEENSLAND SPECIALIST —

UNITED COMPUTER

- *QLD's largest range of software
- *All of the latest titles
- *Full Range of Printers and Cables
- *Quality disks at lowest prices
- *Printer Paper—Labels—Desks
- *Large range of Books

- *Fast turn around service and repairs
- *Mail orders welcome
- *Now in stock A2000, A1000, A500
- *Specialists in education
- *United Computer stores carry the full range of Commodore products

Ipswich
COMPUTERVIEW
21 Brisbane Road
Bundamba
(07) 282 6233

Brisbane
UNITED COMPUTERS
991 Stanley Street
East Brisbane
(07) 393 0300

Gold Coast
SCARBOROUGH FAIR COMPUTER CENTRE
Scarborough Fair Shopping World
South Port
(075) 325 133

DEALERS DEALERS DEALERS DEALERS DEALERS DEALERS DEALERS

I tried the view options and found them to work well. I could, at a glance, see where the money had come from and gone to; ideal information for a small organisation like the AAUA or a home budgeting system. I became hopelessly lost in the "Compare with statement" area. Once in that area, you can't get out without resolving a discrepancy or blindly accepting the bank statement balance, an interesting problem if the bank proves to be wrong!

I wasted a couple of hours trying to get my printer to work. Eventually I discovered the program will not output to print if your system supports two external drives. It's the only software I've had this problem with, not a major hassle, but worth noting. Another tip: use

PHASAR under KS/WB1.2; the disk access time under 1.1 is dreadful!

The budget functions allow the user to project income and expenditure trends and budget accordingly. A handy addition, which, if you have known commitments, should keep you out of the red. As an added bonus, PHASAR has an address/telephone book and diary tucked away in the "List" menu. The simple database concept performs the task adequately.

One excellent function of PHASAR I found quite by accident. We all dread losing data through disk errors. During my juggling of disks I created a read/write error on the PHASAR disk, which the program informed me of the next time I loaded it. Then to

my surprise, it dutifully reconstructed the data files with no loss of information. I was impressed.

The PHASAR disk also contains a Taxation package. I haven't bothered with it as it is formatted for the US tax system.

- PLUS:**
 Pull-down menus
 Mouse/keyboard driven
 Not copy protected
 Ample "HELP" screens
 Data recovery of damaged disks
 Simplified data entry (default system)
 Comprehensive Report generators
- MINUS:**
 Not multi-tasking
 Calendar year (not financial year)
 US taxation system
 Dates are only accepted in US for-

mat: MMMDDYYYY
 No <ESC> from "Statement compare" option

CONCLUSION

PHASAR is well presented and does all it claims. The AAUA now runs its ledgers on PHASAR and it only took a few minutes to run the treasurer through the program. As I stated earlier, a home computer program should be simple to use, easy on the eye and produce the results you want. PHASAR passed all requirements.

I certainly wouldn't suggest BHP swap over tomorrow, but a small organization that needs a simple book-keeping system should take the time to check PHASAR out.

Distributed by OziSoft, (02) 211 1266. RRP is around \$149. □

Barbarian

by Adam Rigby

Had a terrible day? In *Barbarian*, you can release your built-up aggression on the nasties in this underworld. This can be done by various methods, everything from chopping them limb from limb to pulverising with Herculean blows.

You play the barbarian named Hegor, not unlike a man called Conan in the same profession. Hegor, with his long blonde hair and athletic profile, is son to Thoron. Thoron and his brother, Necron, were given special powers when young by a kindly druid who warned them both that Necron would turn to evil while Thoron would oppose his brother, and stand for good. The guts of the story is that Necron fled to the underground and built the world of Durgan - which you must enter to locate and destroy him.

The packaging of the game is of very high quality and the presentation is superb - included are a poster, story outline, reference card and of course, the game.

On-screen play is controlled by a panel which sits on the bottom of the screen, accessed with the left mouse button. The panel includes directions (left, right, up and down), stop, jump, attack, defend and flee. When the right mouse button is pressed another panel is displayed with the current men status, number of arrows, timer, objects carried and three ac-

tions to manipulate them (get, use and drop).

Each screen of *Barbarian* has a problem or problems which must be overcome in order to move to the next frame. The most hazardous tend to be the varied nasties, which are beautifully presented animated sprites/blobs. The trick to *Barbarian* is timing and memory. Since there is no save facility on this game the beginning scenes must be played over and over to continue the search for Necron. This lack of a saving facility is the major drawback of the game.

Barbarian is a very well presented game which will keep you entertained for quite some time. It has enough game play to keep non-adventurers happy, and for the true video-adventurer this will surely be a treat for your senses - the dungeon-style atmosphere is excellently reproduced. The graphics are impressive; animation can become quite jerky, however, if a lot is on screen at once. The sound is adequate - a series of grunts and groans from our hero as he climbs, jumps and hacks.

Graphics	90
Sound	60
Gameplay	80
Appeal	90
Value	92
Presentation	95
Overall	91

Starglider

When they say 'true arcade quality' they are not joking. Man, I thought I had seen the best of the best in smooth simulations, but this just takes the cake! This is a beautifully packaged product - including disk, 64 page novella, flight training manual, full-colour poster and keyboard/loading instructions. The whole thing is presented as if it's the real thing (an understandable mistake).

You sit at the controls of the AGAV (Airborne Ground Attack Vehicle) with the control panel before you. The panel allows critical particulars of your aircraft to be monitored - these include a scanner, energy level, shield status, laser cell status, altitude meter and velocity indicator. Also shown on the console are various navigations indicators such as a sector display and heading read out; this makes it possible to construct a map-of-sorts to assist in refueling etc.

The main difficulty encountered by novice players is refuelling the energy of the ship. This must be done by flying between two energy towers at a very low altitude. The shield and armaments are restocked at the Repair Silos, these are represented by a rotating wedge-like structure which houses the entrance. Learning how to access these two necessities quickly and easily is the key

to the game - without such skill you'll soon find yourself watching a 'game over' message.

The most enjoyable way of playing *Starglider* is with co-pilot, as it is almost too difficult to succeed yourself. When I had a co-pilot to control speed, monitor the

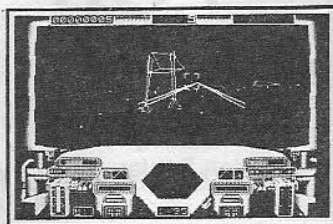

ship's status and fire missiles, my score suddenly was doubled and we were on level two - unimaginable feat!

The sound is unbelievable. The first time I experienced this game it was plugged into a 60w stereo system at full power - awesome!

Starglider is one of the most professional pieces of software on the market today. I must admit the theme of shooting down the aliens is an oldie and does not excite everyone. If not, just have a look at this game, it might change your mind.

Graphics	99
Sound	95
Gameplay	86
Appeal	85
Value	80
Presentation	95
Overall	96

Amiga and Acme. The future is here today

Digiview 2.0

Genlock Digipaint

ProVideo

Hard Drives Futuresound

Memory Expanders

Digiview 2.0

THE Amiga video digitiser. Produce high quality images in colour or black & white in low, high or medium resolution. Uses all of Amiga's 4096 colours with the HAM option. Save images for use in other programs and more

Digipaint

The advanced drawing program utilising Amiga's HAM mode to the full. Uses Amiga's 4096 colours. Combine images with different palettes on the one screen, or work on Digiview images.

ProVideo

The character generator that is the ideal partner to Genlock. Up to 100 screens of animated text in different fonts, colours, sizes and shading can be queued for automatic display. Excellent promotional tool. (PAL version requires extra drive and 1Mb RAM.)

Hard Drives

ACME distribute the entire range of C-Ltd. Hard Drives. Capacities range from 20Mb for under \$1900.00. Turns your Amiga into Super Amiga. Very fast drives that connect directly to the Amiga bus. A real winner in a recent price/performance comparison.

Futuresound

The ultimate sound digitiser for the Amiga. Digitises with NO background noise. Collect samples from your video, stereo, CD or your own voice (microphone included). It's t-t-t-errific!

Genlock

Turns your Amiga into a video production studio. Overlay Amiga graphics/text over a video signal. Chroma-key and fade as well. Very versatile. Lots of professional and educational uses. Australian PAL system.

Memory Expanders

Expand your Amiga's memory without expanding your budget. Half, one and two megabytes of 'fast' RAM available with Auto-Config circuitry and pass through bus. An extra slot is provided so an additional 2Mb card can be added, or even a hard-drive controller. Great value and tops in quality.

Other products include:

ACME Midi Interface, ACME Real Time Clock, Digi-Droid.

DISTRIBUTED BY:

ACME

SOFTWARE

The name that guarantees support and full warranty cover.

PO Box 3 Brighton North, Victoria, 3186. Phone: (03) 596 6732

Contact us for your local ACME dealer

UNLOCK THE POWER IN YOUR AMIGA



- 512 K RAM
- CLOCK
- SCSI PORT
- DMA
- AUTOCONFIG

EXPANSION SYSTEMS

X 1000

for the **AMIGA**

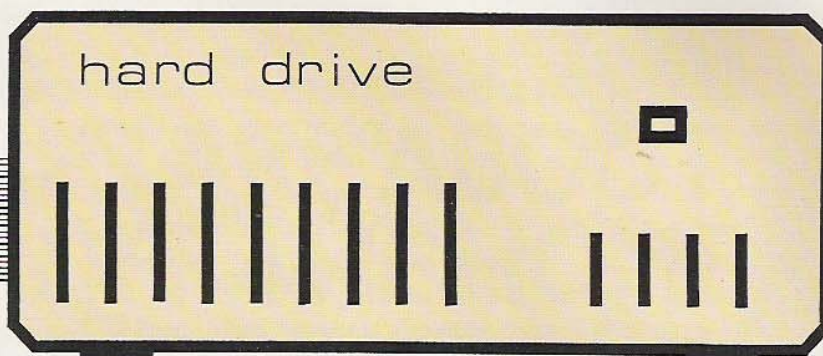

the complete solution for the amiga 1000

In a compact 35mm footprint we put hardware to push your Amiga to new levels of performance.

The X 1000 multifunction expansion unit for the Amiga 1000 uses state of the art technology to enhance the Amiga on all fronts—

- * **RAM** — half a megabyte of fast memory doubles your Amiga's capacity
- * **CLOCK** — real time clock so your programs always know the time and date
- * **SCSI** — industry standard I/O connector for hard drives, streaming tape and CD ROM
- * **DMA** — high speed data transfers to rival workstations and minis
- * **AUTOCONFIG** — of course



Head Office:
Sales and Service:
207 Clarence Street,
SYDNEY 2000.
Ph: 29 5088

North Shore Office:
665 Pittwater Road.,
DEE WHY 2099.
Ph: 981 4455

Arcade Action

with Darren Brown

WELL, back again for another month, and here I got some new hot stuff for all you arcade buffs.

The Last Ninja

First, a game that any martial arts buff will love. *The Last Ninja*.

It is the tale of Akumani, a legendary sword fighter of the Heian period of Japan - about 900 - 1175 AD. The storyline concerns this extremely powerful shogun who captures the scrolls of the Ninja and sets himself up on an island called Lin Fen (a real place) in the Yellow Sea. Ninjas have been dispatched to retrieve the scrolls but they all fail and you, Akumani are the last to try. Fail, and Ninja brotherhood will be lost forever.

The game features six separate locations that act as levels and which load sequentially from disk or tape. The first four sections Wilderness I, Wilderness II, the Palace Gardens and the Dungeons are 25 screens large with the final two, the Lower Palace reduced to 15.

The writers have added as many adventure and arcade adventure elements as possible. The action, of course, comes first from the feet and fists of the Ninja. He's armed to the teeth with shuriken, a sword, nunchakus and a staff. As

always, you have to find the items first before you can use them. There are also numerous other items that will help you along the way that you can find in your travels.

The game requires strategy as well as brute force, so don't think you will finish the game in five minutes just by killing everything.

To top the whole game off, there are 1500 multi-coloured, hi-res sprites in the game's 130 screens. So much care and attention has been dedicated to these background graphics.

Added to the fantastic graphics, you get great music from the one and only Ben Daglish and co-programmer Anthony Leigh. A total of 12 sets of music accompanying each location and six for each load.

To sum the game up it has 60% graphics, 40% programming and 10% music. To give you a total of 110%. But after playing the game, you will agree that is a fair sum. There is just so much involved that you won't finish it in one sitting. Just working out how to somersault will take an average person 10 minutes to perfect.

Overall, I totally recommend you get this one as soon as it is available in the shops. Believe me, it is worth it!

shoot-'em-up, and with solo, two player team and two player dogfight options — a pretty nifty one, too. Realistic aircraft handling and a horizontally-split screen which allows you to keep one eye on your friend / foe's position at all times, are added features of this Hewson game. Should be in the shops soon.

Barbarian

Shortly due for release from Palace Software is *Barbarian*. First of all you have a test of swordsmanship against the "finest warrior in the land". In part two you have to save the Princess from the fiendish clutches of the Dark Sorcerer, Drax. Your skills are extensive, allowing you to headbutt, kick and use the "web of death" as you carry out your mission.

Other features are very well animated sword movements that you also use to defend yourself. One of the sword movements is the yummy decapitation. If you loved the movie *Conan*, you'll love this game. Watch for it soon.

Quartet

Now on the scene is another multi-player game like *Gauntlet*, with almost the same game play, but a different setting. Get ready for *Quartet*. Here's the plot:- Space Colony 06 has been attacked and taken over by space pirates. *Quartet*, a private team of troubleshooters are called in to recapture the colony. The *Quartet* team is comprised of three men and one woman, each with his or her own attributes useful in battle. They work as a team but like *Gauntlet*, only two will be able to play at the one time.

With your team assembled you're ready to wipe out a few lousy pirates. As you work your way through the colony's 36 levels, there are devices that will increase your fighting ability, your strength, give you a jetpack or numerous other features. If *Gauntlet* was your style, add this one to your collection.



The Last Ninja

Eagles

Next on the agenda, we have *Eagles*. Hot from the keyboards of Danish programmers Per Madsen and Bo Nielsen, *Eagles* puts you in the cockpit of the most advanced fighter the Earth has ever known. Unfortunately, you're not on Earth — you're actually orbiting the beleaguered planet Zinox, in a stratosphere swarming with attacking aliens. Yes, it's a

Wonderboy

Wonderboy is here! *Wonderboy* is a kid with a quest: to reach his girlfriend across treacherous landscapes and rescue her from the evil King.

Burning bonfires, tumbling boulders, poisonous snakes, killer frogs and murderous blue midgits can all make your quest a short one — but our hero can break open giant eggs to collect a stone axe, a guardian angel and other valuables to help him on his mission. A skateboard speeds up his progress and picking fruit provides bonus points.

A mastery of jumping is required in this fast action game of skill and timing. Armed with only a nappy, you set out to conquer the land and reach your girlfriend. Good action, but a bit frustrating. Check your local software supplier for this one.

And now, a game every Amiga owner will be familiar with, a game that requires strategy rather than brute button pressing. If you don't know what I am talking about, then I will tell you.

Defender of the Crown. "Never heard of it!" I hear you scream, but you will never want to forget it when you see the amazing graphics and sound.

The game is set in the year 1149, in England. The era of Robin Hood and King Richard. The whole story is based on getting the now anarchist society of England back on its feet after the assassination of the King. Even his crown has been stolen. Everyone blames each other, but while this goes on, the younger men set out to do something about it. You can choose your characters from different rulers of the time.

You start off with a castle and a handful of men as your army. It is your job to increase your land by conquest. Conquer the whole of England and the game is finished.

You have to buy soldiers, knights, catapults and castles. You earn a certain amount each month from each piece of land. The more land, the more income and the more you can buy.

Many strategies are involved and it is a welcome relief from all these new shoot-'em-ups.



Quartet

Overall *Defender of the Crown* is a great game and is a must to see, even if that's all it is, a look, 'cause it is well worth it.

Now for the News

You may have heard of the new James Bond film, *The Living Daylights*. Well, Domark are set to release a game about this great new film. According to what I have heard, the game will be much more of a shoot-'em-up than the last Bond game was. The game will feature all of the locations that are shown in the movie, plus many others. There will even be a part of the game where you go into Q's office and choose your weapon.



Wonder Boy

This new Bond adventure is set to be a hit.

Now, unfortunately, here is a bit of bad news. Despite considerable pre-release publicity - including large adverts in many major magazines - Melbourne House have decided to junk their *Inspector Gadget* game in all formats. So if you see any reviews of the game anywhere you still won't be able to buy it.

The official line is that the Melbourne House people didn't think the game was up to scratch. I have actually seen a pre-release of the game and, I myself, think it was perfectly good, although it could do with some improvements.

Now that we are over that bad news, here is some good news for all *Gauntlet* fans. US Gold have released the promised *Deeper Dungeons* add-on for all versions. More dungeons and treasure-filled rooms to explore. You'll need the original game to load the new dungeons. From what I have seen the *Gauntlet* fans will love them.

I think that's about all for this month. Hopefully, I will be back next month to review more great games, but until then, look around for this month's reviewed games. They are definitely worth it!

Catch ya next month.

NetComm believes Commodore owners have waited long enough.



It seems Commodore owners are a patient lot. While other PC users were discovering the delights of communications, you had to wait for someone to design a modem just for you. And while the others were enjoying the convenience of auto dial and auto answer, you were left waiting again.

But now, with the introduction of NetComm's Modem 64/128 for Commodore, your wait is over.

The Modem 64/128 is a full-feature, two-speed auto modem compatible with all existing commercial and public domain software, including Commodore 1650 software.

It operates at 300/300, 1200/75 and 75/1200 baud.

It comes complete with Videotex and Terminal software and even a VIATEL subscription form.

It provides auto dial, auto answer and auto disconnect features you'd only expect to find on much more expensive modems.

All modem features are software controlled, with a full 7-LED display reporting all operational modes.

And it comes complete, with Telecom approval, ready to plug in and run.

All this, plus NetComm's legendary reliability, for less than \$300, excluding tax.

So now, what are you waiting for?



NetComm

Total Solutions for Data Communications

NetComm (Aust) Pty Ltd • NSW PO Box 284 Pymble NSW 2073 Tel: (02) 888 5533 Telex: AA27488 MODEMS Minerva: 07-DNC002 Viatel: 288855330
VICTORIA 94 River Street South Yarra 3141 Tel: (03) 241 0534 QUEENSLAND Suite 6 Level 11 AMP Place 10 Eagle Street Brisbane 4000 Tel: (07) 229 7376

Virtuoso 64

This is the latest in a long line of music entry programs to cross my desk and it's the best I've seen. The method of entry is simplicity itself and the end result is as good as any I've yet heard.

IT'S billed as a powerful and flexible music editing system that takes your C-64 to its musical limits. You can compose or write music quickly and easily with this system and the result is pleasant and useful. The music files you create are very compact so that very long compositions can be held in memory for a complete performance without further disk access.

The code is interrupt-driven and relocatable and can be used in your Basic or ML programs using the driver program supplied. This is a handy feature if you want to have music playing whilst you do other work or if you've written a game and want to have short musical sound effects to signal various stages.

Your loader program would load these themes to memory and your game program would then call each theme, as and when required, by the SYS to the memory location you've chosen to put the theme music.

It's explained in the instructions which come on the disk and which you print out on your printer.

The program is nice to work with when you've spent just a few minutes reading the aforementioned instructions. I always read manuals through without really comprehending too much (my usual style!) then jump right in and start to use the program.

I had a short tune eight bars long processed in a few minutes. The entry method is probably the easiest and the suppliers claim that what would take an hour to process with the *Music Construction Kit* can be processed in five or six minutes with *Virtuoso 64*.

I haven't done a comparison for myself, but having used so many other music-entry programs I can believe them on this point, as I found the method easy and quick.

The screen displays a double staff (like blank piano manuscript), numbered across the top and bottom to indicate which beat of the bar (called a "measure" in the American convention) the cursor is currently on. Displayed vertically down the left of the screen are the note names on each line and space together with the relevant octave number

"It's billed as a powerful and flexible music editing system that takes your C-64 to its musical limits."

You know where you are by looking at these numbers and letters. The display screen is part of a vertical window and if you need to write notes higher or lower than the lines shown on the staff then you scroll up or down by using the cursor keys.

There's a feature called Edge Scroll which lets you scroll sideways to the adjacent measure either next or previous.

Notes are entered by using the 1, 2 & 3 keys and refer to the three voices on the C-64. The instructions suggest that you place your left hand over the number keys and your right hand over the cursor keys for fast music writing. When you press the appropriate number key the number appears on the line or space where you placed the cursor with the cursor keys.

Numbers are displayed instead of note-heads and you can see at a glance which voice is playing what note. Rests are entered by using the 4, 5 & 6 keys and a rest is shown as R3 for a rest in the 3rd voice. Any note written will continue to play until the next written note is encountered.

This idea cuts out the need for ties and makes writing much simpler to do. The same concept applies to rests and once you've used this program I think you'll agree that it's a marvellous way to write music.

Three-stage method

Virtuoso 64 uses a 3-stage method of building a music file. There are measures (bars), sections and pages in this method. You enter music into a Measure in the Input Mode without having to bother about repeat signs, tempo changes or sound quality. You just put the notes in their right places.

In Section Control you define how the music is to sound by controlling the ADSR (Attack, Delay, Release & Sustain) along with tempo, sound filters and other special effects. It's here that you define in what order the measures of music are to be played. You may wish to repeat measures 1 to 16 straight after measures 32 to 48 and a command here will do that.

If you want the repeated measures to

SECTION MENU / EDIT SOUND PARAMETERS			
Section #	Meas 1	1 - Meas 5	12
	Voice 1	Voice 2	Voice 3
Waveform:	Sawtooth	Sawtooth	Pulse
Pulse %:	50	24	73
Attack:	4	4	0
Decay:	9	9	9
Sustain:	0	0	0
Release:	9	9	0
Sync:	OFF	OFF	OFF
Ring Mod:	OFF	OFF	OFF
Filter:	OFF	OFF	OFF
Type:	High-pass		
Cutoff:	11862 Hz		
Resonance:	0		
Volume:	12		
Tempo:	80	Notes per measure:	12

2/ MUSIC ENTRY/EDIT SCREEN

Measure 1 Increment is 1
 [. . . 2 . . . 3 . . . 4 . . .]

E					
D				1	
C					
B			1		1-2
A					#1
G		1		2	3
F#					
E	1				
D	1	2	2	3	
C					
B	3		3		
A					
G			2		
F#					
E					
D	2	2		2	
C					
B					
A					
G	3		3		

[. . . 2 . . . 3 . . . 4 . . .]

* VOICE 3 PLAYS "D" HERE,
 SCROLL SCREEN TO SEE IT.

**3/ NOTATION EQUIVALENT OF FIG. 2,
 "BILL BAILEY" (1st TWO BARS)**

play louder or softer, faster or slower or in a different octave, you can do that in Section Control. In Page Control you have the facility to tell the program when to play the Sections that you've designed and in what order. So, Measures contain the notes, Sections contain the playing instructions for all Measures, and Pages contain the playing instructions for all Sections.

It sounds a lot more complicated than it really is, but isn't all explanation of any computer subject like that? I find that a

thing that takes 30 seconds to demonstrate on the actual keyboard can take a page and more of written instruction.

When playing a piece done with *Virtuoso 64* you're treated to a display showing from left to right: the Page number, Section number, Measure Number and Note number. Below that is shown the Section as you defined it and below that is a display showing what sound attributes each voice has. Below that again is shown the Volume and Tempo of the piece being played. The screen is extremely functional, as are all *Virtuoso 64* screens, with the emphasis on functional rather than flashy graphics.

Screen colours are Medium Gray background with major lettering in black, page numbers etc in white, and the voices in different colours. Voice 1 is yellow,

voice 2 is red and voice 3 is blue.

Everything you need to write good music code is here and ready to go to work. When working and you need help you just press "H" and the help screen comes up. It is available at any time from any screen.

With regard to the commands, when you print your instructions out you get a separate sheet showing a command summary. There are some hints too as well as a step by step example of how to set up a piece of music in this Page, Section & Measure method.

To perform repeats of certain parts of the music you set it up by using Section Control but if, whilst actually writing, you wish to use Measure 1 in the same place as measure 7 you simply use COPY to effect the automatic writing of that new

NOW AVAILABLE

For Your C-64 OR C-128 (In 64 Mode)

The team that brought you Snapshot 64, the best selling memory capture device on the market, has done it again!

ANNOUNCING SUPER SNAPSHOT — THE ULTIMATE UTILITY CARTRIDGE!!! —

SUPER SNAPSHOT combines several functions into one new cartridge. First and Foremost, **SUPER SNAPSHOT** is a state of the art memory capture device. This means you can load a program into your computer's RAM and at the touch of a button, capture an exact image of your memory. That image can be saved to disk, allowing you to make working, unprotected backups of your software and that's just the beginning **LOOK!**

- Unique interrupt system allows you to access all **SUPER SNAPSHOT** functions from within a running program and then return to the program exactly where you left
 - On board Hi-Res and Basic screen dumps will work with Commodore 1525, 1526 and compatible printers
 - Our **TURBO DOS** is the most compatible cartridge fast loader available
 - Simple to operate thanks to our exclusive window driven menus
 - Unique 24K RAM/ROM system operates completely outside of computer's memory
 - On board **DOSWEDGE** supports devices 8,9,10,11
 - Our ROM based machine language monitor allows you to interrupt a program, make changes and then resume - a hacker's dream come true
- Last but not least, **SUPER SNAPSHOT** is designed to be upgradeable, simple plug in ROMs will allow you to add new modules, such as pre-programmed function keys, turbo format, fast disk copy, fast nibbler, etc., as they become available.

ALL THIS FOR ONLY **\$79.95**

plus \$5.00 P.&P.

EXCLUSIVE AUSTRALIAN DISTRIBUTOR — SHOP 64 COMPUTERS

2 Mead Street Mall, Kalamunda, 6076 (09) 293 3062

Dealer Enquiries Welcome

L.N.G. LABS



**TATTS 4511 for the Victorian Lotto System
OVER \$300,000,000.00 IS WON EACH YEAR IN
VICTORIAN TATTS LOTTO, SO IF YOU WANT TO BE A
WINNER, THEN READ ON.**

TATTS 4511 is a completely self contained program incorporating 6 sub programs which are used to perform a complete analysis of numbers you have chosen. By following the guidelines as laid-out in the 14 page manual provided with each program, you can select those higher-chance numbers thus improving your chance of winning. The main options are LIST, SEARCH, STATISTICS, NUMBERS, CHANGES, and DATA 45. This program stores all TATTS Draws since #413, is expandable to 6 from 48, provides over 30 screens of statistics, plus much, much, more.....

ONLY \$45 + \$3.00 postage and handling

PLATINUM COLLECTION

A believably incredible compilation of the most exciting Graphics and Sound Demonstrations available anywhere. Written by Hackers and Programmers from all corners of the Globe, these programs literally stretch the C64's chip set to the limit of programing imagination. Each of the TEN DISKS comes complete with L.N.G. LABS special menu program to provide convenient loading. Don't be the last person in your neighbourhood to view this Platinum event.

Only \$49 + \$4 postage & packing

MEGAROM Hacker Pack V3.0 For Commodore 64, 64C, & SX64

From the authors of MULTI-KERNEL and MEGA-KERNEL comes their final product tuned to perfection. This 32K MEGAROM now includes one of the most compatible and fastest serial speed enhancements available for Commodore 64 computers. Also included with this package is a very comprehensive 20+ command DOS WEDGE incorporating many new instructions like device changeover, Basic un-new, and drive anti-knock. Then at any time you can enter a complete machine code monitor/line assembler-disassembler, with 25 plus commands. Not to forget

Also Available from WESTEND COMPUTERS
Send you Bank Cheque/Money Order to:
P.O. Box 246 or 10 Lockhart St, Sth Caulfield, 3162
OR Phone Order Direct to : (03) 528 6521

FRENCH POSTCARDS

The program that is sweeping this nation by storm and causing controversy wherever it is seen. The package really packs a punch incorporating raunchy Hi-Res animated graphics and the ELECTRIFYING sounds of "Touch Me" by Samantha Fox. this master piece is a must for any collection!

Real Bargain only \$29 + P.&H.

*All mail order clients must include a signed and dated statement proclaiming that they are over the age of 18 years.

MEGADOS V3.0

from the AUTHORS of SUPERDRIVE MKII DOS

This is a 32K drop-in DOS CHIP for SKAI, CFC, FSD, TAIWAIHO, 1541C, disk drives. This MEGA-DOS chip offers an incredibly versatile range of facilities, while maintaining 100% software compatibility. You can now have an amazing 783 blocks free on your disks and your disk drive will automatically cater for these disks upon insertion. This DOS will format your disks without rattling the head in only 25 seconds, allow up to ten times faster track accessing, provide optional write verify and programablenumber of Header Gap Bytes. But best of all you no longer have to worry about SAVE"@: problems because we've taken the liberty to KILL all the BUGS!

And to top this MEGA package off, we will toss in our BITS'N'PIECES disk, containing over 40 top quality assorted programs and routines.

**Only \$29 plus \$4 postage and packing
1541 version \$35 plus \$4 postage & packing**

measure. This can be done with one or several measures with you setting the start and end of the range of measures to be COPIED.

**“ Everything you need
to write good music
code is here and
ready to go to work.”**

This is like Cut and Paste in a word processor except that it duplicates rather than moves a range. If you do want to do this you use another feature called MOVE which removes the measures from their original position and puts them where you want them. Another command is OVERLAY which allows you to put a measure on top of another one without erasing current notes unless they conflict voice-wise.

When editing your music you may GOTO any measure you specify by number.

You may also INSERT blank measures or DELETE a range of measures as well as LOAD, SAVE, TRANSPOSE, AP-

PEND etc etc and commands are performed by pressing a single letter. These commands are shown on the command summary sheet.

Once you get proficient in the use of *Virtuoso 64* you can use the Macro feature which allows you to define a string of up to five characters which will be entered automatically at the cursor position whenever you press "/" followed by the single letter name of your macro definition.

This is useful for inputting a pattern of notes or cursor movements. If you were to enter Ravel's Bolero and use voice 3 as the percussion you could define the rhythmic pattern as a macro called "R" and input it in every new measure by typing "/R". The ways to use this feature is only limited by your own imagination.

One beef I had was the lack of specific instruction as regards inputting triplets, 32nds and 64ths. The accompanying literature said that they're all possible, "require a little manipulating but turn out well." This they certainly do as you'll hear from the Paganini piece on the master disk.

Triplets are well done here and serious users would check out the way that they've been done in that piece and use the same method themselves. I checked out all the pieces which come on the disk for the use of triplets, those pieces are: *Won't you come home Bill Bailey*, Pachelbel's *Canon*, Beethoven's *Fur Elise*, *Bumblebee Boogie*, Bach's *Brandenburg Concerto No 3*, an un-named Paganini piece plus five of Joplin's rags: *The Entertainer*, *Maple Leaf Rag*, *The Sycamore*, *Weeping Willow* and *Eugenia*, plus one he wrote in collaboration with Arthur Marshall: *Swipesy Cakewalk*.

All are well done, and just for interest I checked out the sheet music for much of them and couldn't find anywhere where Scott Joplin used the triplet figure. It's not used in the Bach or Beethoven pieces so the Paganini was the only piece that did use triplets. The suppliers of *Virtuoso 64* are Chipmunk Software of Battleground, Washington.

They send out a catalog on a disk which keeps you up to date with all their products. They have a nice product range for both C-64 and Plus-4 comput-

Westend

COMPUTERS and STATIONERS



SPECIALISTS

402 BELL STREET
PASCOE VALE SOUTH, VIC., 3044
PH: (03) 3505144

HARDWARE 64/128	GAMES	BUSINESS
Lichtschreiber Light Pen \$50 Designed exclusively for PAL system, includes Cadlight and Picasso's Revenge on Disk. Voice Master Version 2.0 \$50 Speech and Music Digitizer for use in your own programs or just for fun. 1541 Flash \$50 300% faster disk communications plus 30 new Basic commands. Slimline Cases \$39 Upgrade your old C64's appearance to 64C	We stock a full range of all Budget, Premier and Latest-Release titles. Phone or Write for a FREE catalogue.	DFile 128 from Michaelsoft \$69 \$29 DFile 128 Utilities Michaelsoft \$49 \$29 WordFile 128 Michaelsoft \$69 \$29 WordPro 128S Proline \$149 \$99 WordPro 128 Proline \$199 \$89 WordPro 64 Proline \$99 \$69 ProFile 128 Proline \$139 \$89 SwiftCalc 128 Timeworks \$129 \$89 WordWriter 128 Timeworks \$129 \$89 DataManager 128 Timeworks \$129 \$89 Insta Calc Cimmaron \$69 \$29 Insta Writer Cimmaron \$79 \$29 InstaLedger Cimmaron \$79 \$29 EasyFile Commodore \$79 \$29 Future Finance Commodore \$79 \$29 WordPro 3 plus ISS \$79 \$39 Fleet System 2 PSI \$169 \$99 Calc Now Cardco \$89 \$49 File Now Cardco \$89 \$49 Spell Now Cardco \$69 \$39
LANGUAGES PILOT \$39 FORTH \$39 PASCAL \$39 BASIC COMPILER \$39	SYNAPTIC 2001 CBM1541 COMPATIBLE DISK DRIVE Guaranteed 100% Compatible Super Slimline styled casing Low power consumption (15W) Very Quiet Incorporates all the features of Mega Dos V3.0 giving up to 783 blocks free/disk only \$349 plus P&H Please phone or write for a complete catalogue of our products	
Utilities Music Machine \$10 Music Composer \$10 Tool 64 Cartridge \$19 Speed Basic version 5.5 \$19 Acos + \$29	TOTL SOFTWARE SERIES Word and Data Management \$39 Database Management \$29 Business Accounting \$69 Time Management \$19 General Ledger \$29 Keyword Cross Reference \$19	

POSTAGE AND HANDLING FEES

\$3 NORMAL POST \$7 EXPRESS COURIER
\$5 PRIORITY PAID \$9 IPEC OVERNIGHT

ers, also some handy books on customising drives, building computer furniture etc etc.

I got some Music Collections on disk along with the *Virtuoso 64* program, they're called "Strider's Computer Classics" and are on the price list at \$9.95 per disk (or 3 for \$27).

One of them was a Scott Joplin disk with *The Entertainer, Elite Syncopations, Peacherine Rag, Leola, Maple Leaf Rag, Easy Winners, Swipesy Cakewalk, Ragtime Dance, Pineapple Rag, Weeping Willow, The Paragon* and *The Strenuous Life*. The other one was a disk of Bach's *Well Tempered Clavier* which included Fugues 2,7,9,10,11,21 and Preludes 1,2,5,6,11,14,20,21,23.

Each disk has a file of Program Notes covering the disk's contents and each tune, when loaded and playing, displays several screens of text about the tune and it's composer's history.

The Strider disks come up with a title screen when playing the introductory music then present a "select by letter" menu for music choice. These disks come out on a monthly basis and are created by

Lorne Strider using the *Virtuoso 64* program.

If you have any music files created by *Master Composer* there's a conversion file on the *Virtuoso 64* disk which makes them *Virtuoso* compatible.

If you're interested in a simple to use yet full-featured music program then I suggest that you have a look at this one.

Virtuoso 64 costs \$29.95 from Chipmunk Software, 631 North Cherry Street, Battleground, Washington, USA 98604. Phone 1-206-687-2343.

All quoted prices are in US dollars.



COMMODORE COMPUTERS



Specialising in
Commodore's wide range of
hardware and software

WE OFFER:

- * Professional advice
- * Competitive prices
- * Wide range of Epson and Okimate printers
- * Service by our trained technicians
- * Generous trade-in prices

Please enquire about the exciting new range of Commodore PCs and Amigas being released this month.

ACCOUNTABLE COMPUTERS

BONDI JUNCTION KINGSGROVE
11a Waverley St 331 Stoney Creek Rd
(02) 389 9589 (02) 502 2430

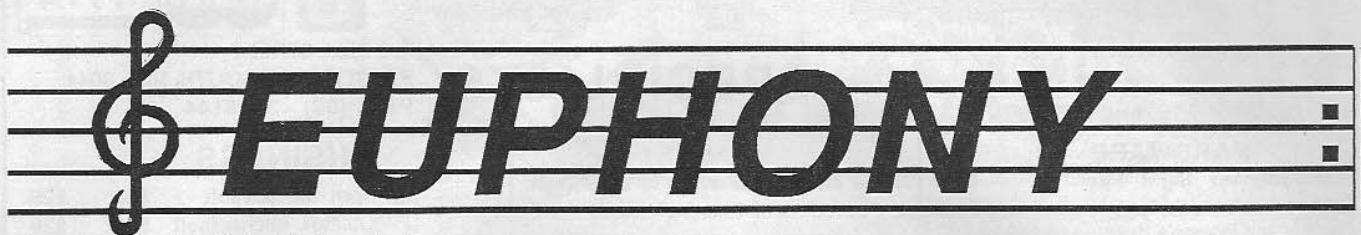

EUPHONY

An update by Eric Holroyd

I liked this music program so much that I contacted the guy who wrote it, Jim Raymond of TCO Software of Alaska. He was delighted that his program has made an impact and said that he regularly quotes a satisfied customer in ads as "Mr M.L. of Castle Cove, Australia". His ads show many more "satisfied customer letters" and I believe rightly so. It's a good program.

Mr Raymond sent me details of the updated version, known as *Euphony 3.0*, which has many new features. Here they are.

It's now permissible to use 64th notes and dotted 32nd notes, also any combination of durations can now be done. Previously some combinations were not "legal" in this program but that's been fixed.

There's a new, improved voice menu where the cursor will only move to "legal" positions. In previous versions you could put the cursor anywhere and inadvertently cause a problem if you pressed the return key with the cursor in the wrong place. There's also an improved Help menu.

One thing I was a little critical of in the previous version was the preset (and unchangeable) screen colours. I felt that different colour choices could have been a benefit to users who have a normal TV set instead of a monitor and who therefore don't get as good screen resolution. This new version allows you to set the colours to whatever you like best and the change is written to disk so that your own choice of colour comes up every time.

There's better access and control to the sound chip with noise waveform, vibrato, sync and ring modulation all being easily available when designing your instrument sounds. The preset instruments are still there too.

The metronome frequency and/or time signature can now be located in variables and you can therefore change the timing or speed of the piece in the middle

of a phrase, whereas before you had to define it at the start of a phrase. There is now no restriction on where you put this command.

In the areas of disk and file handling there are a couple of nice changes too. The Number command (for renumbering source files) is now stored in RAM so that renumbering and inserting is done almost instantaneously. Also, the disk directory now shows the file-length.

There's now a key displacement command which actually allows you to save a piece of music in a different key to the one you wrote it in. You just change the key of the file by transposition then save it with this method, it's that simple. Of course, you'd need to use a slightly different filename if you wanted to save several versions of the same file on one disk but you could put the key into the filename to make recognition easy. For example, Blues in C could be the same tune as Blues in A but transposed and saved with the key displacement command.

Three hours of music

Finally, whilst Music Collection 1 is included on the program disk, you now get a second disk with Music Collections 2 and 3 which gives a total of three hours of music ready to play on your 64.

Here's what you get in the Music Collections:

Collection 1:

Beethoven's Waldstein sonata, Bach's Fugue in D minor, Mozart's Sonata in A minor, Introduction to Chopin's Polonaise in A flat, Pachelbel's Canon in D, plus pieces by Scott Joplin and others.

Collection 2:

Introduction to Beethoven's Appassionata, Mozart's Sonata No 9 in A minor, Bach's English Suite No 2. There's the Sinfonia, Chorus, Arioso, Air and Hallelujah Chorus from Handel's Messiah plus many hymns and Christmas carols.

Collection 3:

Bach's Brandenburg Concerto No 3 (John Pearce's theme music), Mozart's Sonata No 11, Debussy's Golliwog's Cakewalk, Chopin's Fantaisie Impromptu, together with pieces by Tarrega, Albeniz, Prokofiev, Couperin and others.

Collection 4:

(Sold separately for \$7.50 plus \$1.00 shipping) Beethoven's Moonlight Sonata, Bach Bourrees, pieces by Brahms, Mozart, Schumann and more.

Each Music Collection runs for approximately one hour.

Further information sent from TCO Software includes the following:

If you don't want to enter or write music you can just get *Euphony Junior* which is the program that plays the Music Collections. Included are Collections 1, 2 & 3.

Euphony+ is the same as *Euphony 3.0* with the addition of printer drivers for Epson and Star Micronics printers which enable you to print out your music.

Euphony Junior -
\$19.95 + \$2.00 shipping

Euphony 3.0 -
\$39.95 + \$2.00 shipping

Euphony+ -
\$44.95 + \$2.00 shipping

All prices quoted are in US dollars.

TCO Software Box81504,
Fairbanks, Alaska, 99708
Ph 907-479-4898

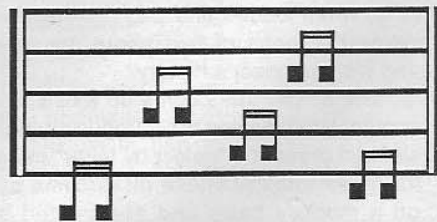

Australian Commodore Review Disk Magazine No 7

Now Double Sided

with 128 Software too

Title	Category	Size	Usage	Title	Category	Size	Usage
Side 1				Side 2			
Anti-Isepic	Utility/Disk	12	Removes Isepic fastloader	Chord Maker	Music/Printer	24	Prints chords of any instrument
Sledgehammer	Utility	30	Program Compactor.	Dark Forest	Entertainment	33	Multi-player strategy game.
Fast Format	Utility/Disk	6	High Speed Disk Formatting.	Side 2			
Joystick Tester	Entertainment	4	Test joystick for faults.	Karate Kid II	Graphic/Still	22	Demonstration Only
Irish Jokes	Entertainment	32	Humerous collection for reading	Thrust Concert	Music/Animation	48	Demonstration Only
Renumbr	Utility	9	Renumbr program lines	3D Demo	Lo-Res 3D Anim	20	Demonstration Only
PS/PM/NR	Utility/Printer	74	Converts graphics to/from	Don Martin	Graphic/Anim	104	Cartoon
Convertor			Printshop/Printmaster/Newsroom	No More Heros	Graphic/Anim	49	Demonstration Only
PS Printer	Utility/Printer	18	Prints Printshop Clipart	Recursion	Graphic Still	22	Demonstration Only
Ultimate Writer	Home/Business	23	Generates message using key stroke recording	Funny	Digitised Sample	39	Entertainment
Graphics Editor	Utility/Graphics	48	Sprite/Character Editor. (M/C)	Transputer	Graphic/Anim	68	Educational/Demo Only
Home Finance	Home/Business	23	Calculates interest, loans etc	Classics	Music	193	Listening/Demo
Oscilloscope	Hobbyist	9	Traces wave input via interface	Special	Graphic/Anim	51	Demonstration Only
Dice Roller	Entertainment	8	Displays throw of multiple dice	Bootmaker 128/64	Utility C128	8	Modify boot sequence.
				Convert Basics	Utility C128/64	15	Identify BASIC differences

AND A COLLECTION OF 128 SOFTWARE

ORDER FORM

Name.....

Address.....

.....Postcode.....

Cheque.....Bankcard.....AMEX.....No:.....

Signature..... Send me.....copy/s of Disk Magazine no 7 at \$12.00 each plus \$1.00 P. & P.
Post to : AUSTRALIAN COMMODORE REVIEW, TOP REAR, 4 CARRINGTON RD, RANDWICK, NSW 2031 (02)398 5111

One liners

by Paul Blair

THE first routine is one I've always wanted, and the C128 makes it easy. There I am, wanting to print something on the screen, jump off to another spot to print something else, then return to where I left off, to print more.

Basic 7 has two routines to help me do this, SAVEPOS and RSTRPOS at \$CC1E and \$C932 respectively. SAVEPOS saves the current cursor location (column and row) at \$DE/\$DF. RSTRPOS recovers them and puts you back whence you came.

Try this from Bank 15.....

```
1SCNCLR:CHAR0,4,7,"THISISUP HERE"
```

```
2SYS52254:SLEEP2:CHAR0,11,20,"LO OK!"
```

```
3SYS51506:SLEEP2:PRINT" AGAIN"
```

The second routine came of desperation. I wanted to find (quickly) where a certain program was stored on a disk. I tried reading the directory, but that all takes time. Too slow.

Then I figured that the 1541/1570/1571 Disk Operating System does it all anyway when it opens a file. Hmmm.

The trick is to find which internal buffer has been set when the OPEN command is issued. DOS uses location \$F9 in the disk drive to store the number of the buffer (0-5 in the 15** drives) that will

be used. Line 20 reads the buffer number.

Knowing this, we have identified which of the "pairs" of track and sector values stored between \$06 and \$11 in the drive we want for the file in question. Buffer 0 uses \$06 and \$07, buffer 1 uses \$08 and \$09, and so on. A quick fix in line 30, and we can get the values we want.

```
10SCNCLR:Z$=CHR$(0):INPUT"WHICH FILE";NM$:OPEN15,8,15
20OPEN2,8,2,NM$:PRINT#15,"M-R"CHR$(249)CHR$(0)CHR$(1)
30 GET#15,A$:BF=6+2*ASC(A$+Z$)
40PRINT#15,"M-R"CHR$(BF)CHR$(0)CHR$(2)
50GET#15,A$,B$:TR=ASC(A$+Z$):SC=ASC(B$+Z$)
60CLOSE2:CLOSE15:PRINT"TRACK"TR"SECTOR"SC
```

Define your wishes

Part II

This month Jason Briggs tackles some of the more fancy stuff - multi-coloured characters, memory positions, and UDG's without CBM transfer.

Multi-coloured UDGs

Multi-coloured UDG's, so what's the big deal about multi-colour? It just makes your programs look really 'unreal' or 'virtual' if you're a science freak.

Another reason for using multi-coloured UDG's is to gain a graphics effect that normally you wouldn't be able to.

These are only two reasons; as we learn about the multi-colour feature, you will probably find more uses.

Read on and learn, I hope!

Designing multi-coloured UDG's is a very long and tedious job, that is if you don't have a good character editor.

To ease things a little I think that you should read the following information. For starters, try the *Australian Home Computer GEM*, Vol 2 No1, page 38, under the heading of Designing Multi-Colour Sprites.

After you have read this try Multi-Colour Mode Graphics on Page 115 of the Programmer's Reference Guide.

Both of the above references should pretty well cover the topic, but what if you don't have either of them? Well, the first thing you should do is go out and buy the Programmer's Reference Guide, that is if you intend to get into programming in a big way. The second thing you should do is read the brief outline that I have supplied below. If you feel quite at ease with the designing of Multi-coloured UDG's then just skip over the next section.

Designing multi-coloured UDGs

When it comes down to the crunch line, there is really only one difference between designing normal and multi-coloured UDG's.

This difference is in the grid size of the UDG. As I mentioned in Part I of this article (*Australian Commodore Review* Vol 4 No 6, June), the normal UDG grid section is made up of eight bits wide, and eight bits down.

When we enter multi-colour mode, this grid changes in size and becomes four wide, and eight down. That isn't to say that multi-coloured UDG's are only half the size of normal ones.

Instead you must learn to work with pairs of bits, the computer no longer colours in just one bit. It does in fact colour pairs of bits in the same colour.

This means that your bits across in multi-colour mode, are twice the size as those in normal mode. The reason behind doing this is so that you have a choice of three colours, any of these three colours can be chosen by selecting the correct combinations of bits.

This is better explained in the diagrams below.

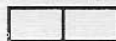

This combination selects background colour. (Register - 53281)



This combination selects colour #1. (Register - 53282)



This combination selects colour #2. (Register - 53283)



This combination selects colour RAM. (Register - colour RAM)

This means that when you draw up a

design grid for multi-colour UDG's, you have to use one of these combinations to get the desired shapes.

The colour values of these bit combinations are selected by POKEing the desired value into multi-colour registers. (Also shown above.) As you can guess from above, the first three colours are set for all of the UDG's. That is to say, if you select red for colour #1, then ALL of the UDG's which have colour #1 in them will use red. This also applies for colour #2, but there is something special about the colour memory. What does it mean by colour memory?

OK, this is really going to be difficult for me to explain, but here goes.

The colour Ram combination is a feature that allows us to decide which characters are going to be multi-colour. Let me put it to you another way, what would happen if you used normal text characters, with multi-coloured graphics? I'll tell you what would happen, your text characters would be an absolute mess. As in 'Yharr!! Go for the reset switch.' This is where the colour Ram option comes into its own.

If you so wish, we can select a certain character to be either multi-colour or normal colour. Well, how is this done?

Easy, if we choose to place one of the first eight colours into the colour Ram, then this will display that character in normal colour. If on the other hand you choose one of the last eight colours, (ie. 8-15), then the UDG's will be displayed as multi-colour. To make this a little clearer, study the following list.

COLOUR CODE	EFFECT
0	Normal colour mode - character black.
1	Normal colour mode - character white.
2	Normal colour mode - character red.
3	Normal colour mode - character cyan.
4	Normal colour mode - character purple.
5	Normal colour mode - character green.
6	Normal colour mode - character blue.
7	Normal colour mode - character yellow.
8	Multi-colour mode - Ram colour black.
9	Multi-colour mode - Ram colour white.

- 10 Multi-colour mode - Ram colour red.
- 11 Multi-colour mode - Ram colour cyan.
- 12 Multi-colour mode - Ram colour purple.
- 13 Multi-colour mode - Ram colour green.
- 14 Multi-colour mode - Ram colour blue.
- 15 Multi-colour mode - Ram colour yellow.

There is one more thing that you'll need to know. And that's how to turn multi-colour mode on and off. Actually it was pretty poor of me to leave this till now, but better late than never I guess.

```
POKE53270,PEEK(53270)OR16
- This turns multi-colour on.
POKE53270,PEEK(53270)OR16
- This turns multi-colour off.
```

Well, that's all there is to it. Quite easy if you think about it - well, maybe it isn't. I feel as though I may have made a rather bad job of explaining this section, but then again I had a lot of trouble understanding it at the beginning too. So to help you out, I've done up a small demo listing.

If you have any troubles, just refer to the REMarks for an explanation. This demo will simply show you a few lines, some in multi-colour, and some in normal mode. However, it should be noted that the entire screen is set in multi-colour mode. The lines are just printed using different colour Ram values.

And one more thing, always be extra careful when designing multi-coloured UDG's. It's a common mistake to get the pairs of bits mixed up when design is done manually.

```
5 PRINTCHR$(142)
10 POKE52,48:POKE56,48:CLR
20 POKE56334,PEEK(56334)AND254
30 POKE1,PEEK(1)AND251
40 FORI=0TO511:POKEI+12288,PEEK(I+
53248):NEXT
50 POKE1,PEEK(1)OR4
60 POKE56334,PEEK(56334)OR1
70 POKE53272,(PEEK(53272)AND240)+12
80 REM — THIS IS THE NORMAL CBM
TRANSFER PROGRAM —
90 POKE53270,PEEK(53270)OR16:REM THIS
TURNS MULTI-COLOUR ON
100 POKE53280,0:REM BORDER BLACK
110 POKE53281,6:REM SCREEN DARK BLUE
120 POKE53282,5:REM COLOUR #1 GREEN
130 POKE53283,12:REM COLOUR #2 MED-
GREY
140 PRINT"[BLK]NORMAL COLOUR - VALUE
0"
150 PRINT"[WHT]NORMAL COLOUR - VALUE
```

```
1"
160 PRINT"[RED]NORMAL COLOUR - VALUE
2"
170 PRINT"[CYAN]NORMAL COLOUR -
VALUE 3"
180 PRINT"[PURP]NORMAL COLOUR -
VALUE 4"
190 PRINT"[GRN]NORMAL COLOUR - VALUE
5"
200 PRINT"[BLUE]NORMAL COLOUR - VALUE
6"
210 PRINT"[YELO]NORMAL COLOUR -
VALUE 7"
220 PRINT"[ORNG]MULTI-COLOUR - VALUE
8"
230 PRINT"[BROW]MULTI-COLOUR - VALUE
9"
240 PRINT"[LRED]MULTI-COLOUR - VALUE
10"
250 PRINT"[GREY1]MULTI-COLOUR - VALUE
11"
260 PRINT"[GREY2]MULTI-COLOUR - VALUE
12"
270 PRINT"[LGRN]MULTI-COLOUR - VALUE
13"
280 PRINT"[LBLUE]MULTI-COLOUR - VALUE
14"
290 print"[GREY3]MULTI-COLOUR - VALUE
15"
```

Memory addresses for your UDGs

This has got to be one of the easier topics to write about, after all I only have to explain to you the possible memory positions and what we use them for. Those of you who are familiar with my writings are probably saying, "Here he goes again!! Why are you doing this to us, Andrew?"

Well I've got good news for you, and NO Andrew isn't going to get rid of me. (I HOPE! Gulp.)

The good news is that this is really simple. First of all, there are three places in the C64's memory where UDG's are most often placed. These memory addresses are listed below:

12288 - 14328 or \$3000 - \$37F8
 8192 - 10232 or \$2000 - \$27F8
 2048 - 4088 or \$0800 - \$0FF8

As you can see, all three of these memory areas are located pretty low in memory. This has both advantages and disadvantages.

The first and most obvious is that it leaves very little room for a BASIC program. For those of you who don't know where the BASIC programs normally start, they are located at 2048 and gradually move up in memory.

Let's look at the three memory locations in relation to BASIC Ram.

2048 - 4088 or \$0800 - \$0FF8

Is ruled out straight away. This memory location sits smack on top of our BASIC programs, so of course it is useless, right? WRONG! There are two ways that the more advanced programmer could use this area of memory for his/her UDG's.

The first comes into use when we start programming in Machine Code. Most people know that Machine Code can be placed anywhere in memory, that means putting your UDG's down in this memory location would be quite handy. Let's face it, placing UDG's down there is a great way of keeping them out of the way of everything else.

The second way of using this memory area would be to transfer your BASIC Ram to a high starting location. However that is a long story in itself, and needless to say is beyond the level of this article.

8192 - 10232 or \$2000 \$27F8

This area of memory is a little more interesting to the average user. For starters, you don't have to start swapping BASIC Ram about to use it. And secondly, we are given a limited amount of room for a Basic program, this means that you won't have to dive into the world of Machine Code.

Well, what are its disadvantages? I guess the fact that it leaves you with only about 6K to write your Basic program in. Those of you who do understand Machine Code, can once again use the area for storing UDG's and place other information around them.

12288 - 14328 or \$3000 - \$37F8

I've kept this one till last because it's the best general purpose memory area. As you can see, it gives you roughly 10K of Basic Ram to muck about with. To the Machine Code programmer, it allows ac-

cess to the surrounding memory locations for storage of other information.

The only real hang up I would have about using this area is the fact that it is located so high. When programming in Machine Code, I prefer to use that area for storage of screen data etc. This is my advice to other MC programmers, unless you wish to do something special, then use one of the lower memory areas.

This brings us to our next snag, how do we tell the computer where our new character set is? Easy, with one of the following three command lines:

```
POKE53272(PEEK(53272)AND240)+12
- This will set the characters at 12288.
POKE53272(PEEK(53272)AND240)+8
- This will set the characters at 8192.
POKE53272(PEEK(53272)AND240)+3 -
This will set the characters at 2048.
```

Well, those are the command lines, and you can see from the remarks exactly what each line does. You should have used them before from Part 1 of this article, and I therefore assume that you are familiar with the use of all three. If you're not, then to use one of the lines above, just type it in. Either in a program, or through direct entry.

You now know where you can place your UDG's and how to activate them. So why don't you try putting your little bag of tricks into use?

When you're writing your UDG's program, try including some multi-colour designs, then switching into multi-colour mode.

I haven't done you up a demo at this point in time, because I wish to cover one more topic, then hit you with it all at once.

Once you have written your own doodle program, and are happy with it, please read on.

UDG'S without CBM transfer

Now we come to the last topic that I will cover in this article - how we can use UDG's without first transferring the Commodore character set into Ram. And how can we possibly carry out this piece of black magic? Simple, just read in your new character data. Don't bother about doing any transfer routines first.

But before you rush in and do that, there are a few little things you have to know. These snags should be checked off in this order.

1) Ensure that you have data statements for all of the characters. This includes A-Z, the SPACE character and the numbers 0-9.

2) Once you have all of that data, make sure that it is placed in the correct order, ie, that the data for the character A, is in the correct memory location for the keystroke A.

If you follow these two hints you can't really go wrong. However, please note that I have stated the SPACE key in particular. Failure to redesign the SPACE character will have some pretty ugly side effects. The data for a normal SPACE character is easy, 0,0,0,0,0,0,0,0 That's it, please make sure that you put it in correctly.

So that you know which character follows which, you should refer to the Programmers Reference Guide, Page 376, Appendix B. From looking at this table, I can tell straight away that the colon follows on straight after the digit nine.

In time you will come to remember the order quite well, but make sure that you have the list at all times.

That's about all that we really need to know, from here on in the sky is the limit.

I've done you up a little demo program that covers multi-colour mode, memory addresses, and UDG's without CBM transfer. So if you have queries, this program should sort you out.

```
10 POKE53270,PEEK(53270)OR16: REM
SWITCH TO MULTI-COLOUR MODE
15 POKE53282,0:REM COLOUR #1 - BLACK
20 POKE53283,8:REM COLOUR #2 -
ORANGE
70 POKE53272,(PEEK(53272)AND240)+
12:REM SWITCH INTO UDG MODE
80 FORI=12288TO12551:READA:POKEI,A:
NEXT:REM READ IN UDG DATA
90 DATA85,169,169,169,85,154,154,154
100 DATA126,102,126,102,102,0,0,0
101 DATA120,102,120,102,120,0,0,0
102 DATA126,102,96,102,126,0,0,0
103 DATA120,102,102,102,120,0,0,0
104 DATA126,96,120,96,126,0,0,0
105 DATA126,96,120,96,96,0,0,0
106 DATA126,96,102,126,6,30,0,0
107 DATA102,102,126,102,102,0,0,0
108 DATA24,24,24,24,24,0,0,0
```

```
109 DATA30,6,6,102,126,0,0,0
110 DATA96,102,120,102,102,0,0,0
111 DATA96,96,96,102,126,0,0,0
112 DATA102,126,126,102,102,0,0,0
113 DATA126,102,102,102,102,0,0,0
114 DATA126,102,102,102,126,0,0,0
115 DATA126,102,126,96,96,0,0,0
116 DATA126,102,102,102,126,12,15,0
117 DATA126,102,126,120,102,0,0,0
118 DATA126,96,126,6,126,0,0,0
119 DATA126,24,24,24,24,0,0,0
120 DATA102,102,102,102,126,0,0,0
121 DATA102,102,102,102,24,0,0,0
122 DATA102,102,126,126,102,0,0,0
123 DATA102,102,24,102,102,0,0,0
124 DATA102,102,126,24,24,0,0,0
125 DATA126,6,24,96,126,0,0,0
126 DATA120,96,96,96,96,120,0,0,0
127 DATA12,26,48,124,48,98,252,0
128 DATA30,6,6,6,6,6,30,0
129 DATA0,24,60,126,126,24,24,24
130 DATA0,24,56,127,127,56,24,0
131 DATA0,0,0,0,0,0,0,0
200 FORI=12672TO12751:READA:POKEI,A:
NEXT
201 DATA126,102,102,102,126,0,0,0
202 DATA24,120,24,24,126,0,0,0
203 DATA126,6,126,96,126,0,0,0
204 DATA126,6,126,6,126,0,0,0
205 DATA102,102,126,6,6,0,0,0
206 DATA126,96,126,6,126,0,0,0
207 DATA126,96,126,102,126,0,0,0
208 DATA126,102,6,6,6,0,0,0
209 DATA126,102,126,102,126,0,0,0
210 DATA126,102,126,6,6,0,0,0
220 REM --- DEMO ---
230 POKE53280,0:POKE53281,5
240 PRINT"[CLR][LTGRN]@@@@@
@@@@[WHT] THAT IS IN MULTI COLOUR"
250 PRINT"[DWN][YEL]@@@@@
@@@@[WHT] THAT IS IN NORMAL COLOUR
MODE"
260 PRINT"[DWN][BLK]ABCDEFGHIJKLMNO
PQRSTUVWXYZ"
270 PRINT"[^] 1234567890"
```

Well, that's that. Nothing more that you shouldn't be able to work out for yourself, with time of course. The most important thing that you should do is get a decent character editor. I've been informed that a person can get hold of an excellent character editor from Disk Magazine Number Four. So give it a go, there's nothing too difficult about UDG's.

The fast change button

by Joe Fixit

WHEN I bought my Commodore 128D it was to be used as a word processor (*Superscript*). The fact that it could mimic the C64 was an added bonus.

I soon acquired some games (for the kids, of course) and having had a VIC-20 with datasette previously I was pretty impressed with the speed at which disk-based programs were loaded.

Eventually, however, I realised that the 1571/1541 disk drive is not fast as disk drives go, so when I saw the Fast Load cartridge for sale I thought I'd give it a go, even though I wasn't sure that it was compatible with the 128 in 64 mode.

It is compatible and it is effective in speeding up the disk loading sequence. But it locks the 128 into 64 mode.

This is because the kernal reset routine in conjunction with the memory management unit (MMU) checks pins 8 and 9 of the expansion connector. These pins are called game and exrom respectively and if either or both of them are low during the reset routine then the 128 switches to 64 mode.

These pins have other functions also, but suffice it to say that the Fast Load cartridge holds exrom low.

I soon tired of plugging the Fast Load cartridge in and out and winced at the thought of the contacts in the expansion connector fatiguing or being accidentally bent.

Some means of switching the cartridge in and out was needed. Having been employed in the electronics industry for over 20 years (good grief, is it that long) and having designed and built quite a few successful audio, video and digital devices I felt confident that the Fast Load cartridge could be modified.

So, biting the bullet, I gingerly opened my cartridge and began by analysing the internals. Basically, all that is in the cartridge is a 7407 to perform some logic and buffering functions and a ROM (similar to the 23256 as used in the 128) mounted on a double sided printed circuit board.

The exrom line was easy to disconnect but somehow the eight data output lines had to be disconnected to prevent unexpected craziness occurring.

Fortunately most ROMs have an output 'select' pin (22 in this case) which effectively open circuits the data output buffers; second problem solved. I use a miniature high-speed power tool to drill printed circuits, grind plastic, etc. It is indispensable when discretely cutting p.c. tracks.

So I cut exrom and pin 22's connections and plugged the board into my 128. Eureka! It was as if the cartridge was not there. Everything functioned normally in 128 mode.

Next problem.

Simply reconnecting exrom and pin

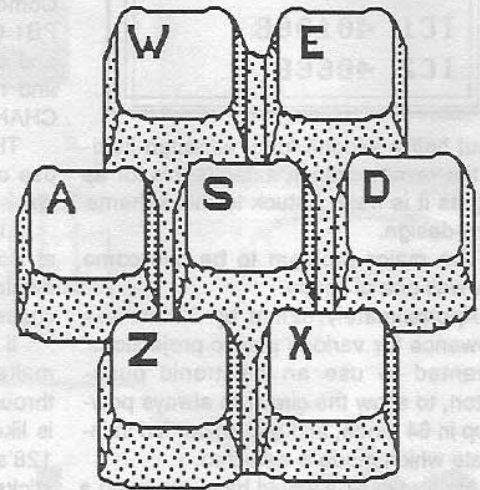

22 would not initiate 64 mode, a reset pulse would be necessary. You can see how these things grow! A bit of checking revealed that in the 128 the reset pulse is

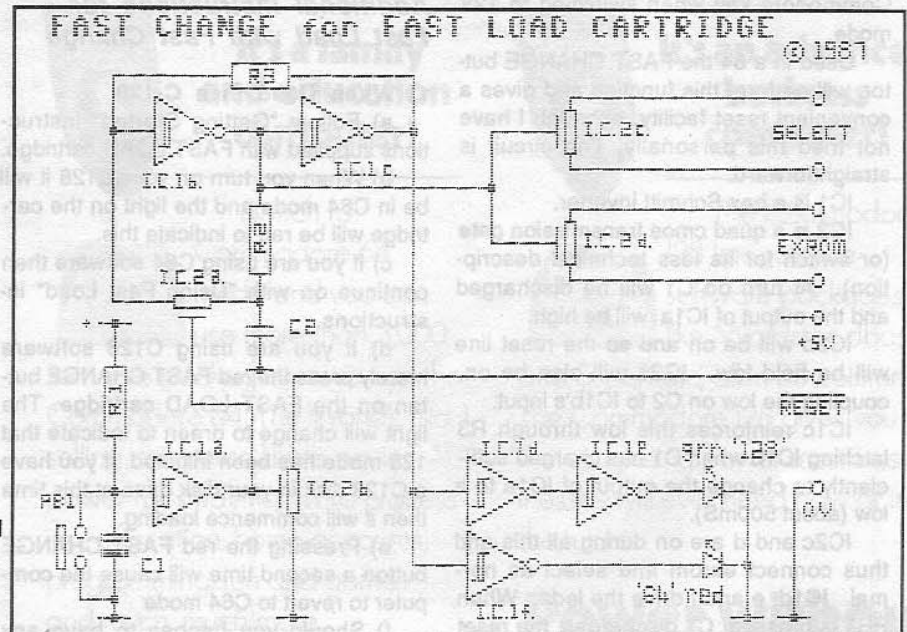

PARTS LIST

R1 470K

R2, 3 220K

C1 1µF 16V Tag

C2 100n Ceramic

IC1 40106B

IC2 4066B

about half a second long, although holding the reset button in extends this for as long as it is held. I stuck to this scheme in my design.

The major problem to be overcome now was one of space.

Approximately 62mm by 22mm less allowance for various plastic projections. I wanted to use an electronic push-button, to allow the circuit to always power up in 64 mode, and a bi-colour led to indicate which mode is selected.

My first design would have occupied a board 75mm square! A bit of rethinking yielded the current design (which just fits) so I made a prototype and fitted it into my cartridge. Some extra benefits accrued from this modification.

Switching the Fast Load cartridge in and out is possible by holding down the Commodore key when switching to 128 mode.

Used in a 64 the FAST CHANGE button will perform this function and gives a convenient reset facility, although I have not tried this personally. The circuit is straightforward.

IC1 is a hex Schmitt inverter.

IC2 is a quad CMOS transmission gate (or switch for its less technical description). At turn on C1 will be discharged and the output of IC1a will be high.

IC2b will be on and so the reset line will be held low. IC2a will also be on, coupling the low on C2 to IC1b's input.

IC1c reinforces this low through R3 latching IC1b when C1 has charged sufficiently to change the output of IC1a to a low (about 500mS).

IC2c and d are on during all this and thus connect exrom and select as normal. IC1d, e and f drive the leds. When PB1 is pressed, C1 discharges, the reset

line goes low and IC2a connects C2 (which has since charged high through R2) to IC1b's input, causing IC1c to latch it through R3 when the reset pulse is gone.

IC2c and d will be off and exrom and select disconnected.

The FAST LOAD cartridge is now out of action and a 128 will be a 128 (if the Commodore key was up). Each press of PB1 thus inverts the state of IC1b and c and connects/disconnects the cartridge and resets the computer, hence FAST CHANGE.

The circuit is here for your personal use only, should you wish to make one up.

I have arranged with Computerscope at Hornsby to make updated cartridges available and to update previously purchased cartridges.

If there is sufficient interest I will make kits for the D.I.Y.'s available through Computerscope. My next project is likely to be a joystick selector for 64/128's with selection from several joysticks at the touch of a button.

I had thought about designing a cartridge motherboard system, but these are already available.

If you have any ideas for gadgets then let me know through the magazine or Computerscope at Hornsby. Have fun

Additional Instructions for Fast Load with Fast Change

1) When Used in a C-128

a) Follow "Getting Started" instructions supplied with FAST LOAD cartridge.

b) When you turn on your C128 it will be in C64 mode and the light on the cartridge will be red to indicate this.

c) If you are using C64 software then continue on with "Using Fast Load" instructions.

d) If you are using C128 software merely press the red FAST CHANGE button on the FAST LOAD cartridge. The light will change to green to indicate that 128 mode has been initiated. If you have a C128 disk in your disk drive at this time then it will commence loading.

e) Pressing the red FAST CHANGE button a second time will cause the computer to revert to C64 mode

f) Should you happen to have any

C64 software that will not load successfully with FAST LOAD, from C64 mode press the red FAST CHANGE button whilst holding down the Commodore key at the bottom left-hand side of the keyboard. The light will change to green. When the computer has reset it will still be in C64 mode but the FAST LOAD cartridge will be disabled. This has much the same effect as typing <[,D> with the added enhancement that the FAST LOAD cartridge may be re-enabled by pressing the red FAST CHANGE button.

2) When used in a Commodore 64

a) Follow "Getting Started" instructions supplied with FAST LOAD cartridge.

b) When you turn on your C64 the FAST LOAD cartridge will be enabled and the light on the cartridge will be red to indicate this.

c) Continue on with "Using Fast Load" instructions.

d) Should you happen to have any C64 software that will not load successfully with FAST LOAD, press the red FAST CHANGE button. The light on the cartridge will change to green. When the computer has reset, the FAST LOAD cartridge will be disabled. This has much the same effect as typing <[,D> with the added enhancement that the FAST LOAD cartridge may be re-enabled by pressing the red FAST CHANGE button.

e) The FAST CHANGE button is a convenient way of resetting your C64. Just remember that you will need to press it twice if you wish to continue on with the same status, i.e. FAST LOAD on or off.

3) NOTES

a) The FAST LOAD functions are unavailable in C128 mode.

b) When the red FAST CHANGE button is pressed the computer is reset and valuable data will be lost if it has not been previously saved to disk or tape.

c) Now there really is no need to remove the FAST LOAD cartridge.

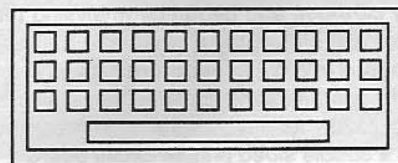

What's the offer?

Any four disks for just \$30!

Public Domain Software Saturday Computer Services

Following the success of our special disk offer, we have decided to provide a new service to readers of *Australian Commodore Review*. Each month we will publish an up to date listing of our catalog. There will also be a more detailed listing of what is on one particular disk. You will be able to order any four disks for \$30.00 - that's including package and posting. Simply fill in the order numbers of the disks you want, and enclose a cheque or money order for thirty dollars made payable to Saturday Computer Services. Send to Public Domain Software, 19A Frederick St, Putney, 2112. Your order will be dispatched the same week we receive it.

Administration	AA	Mathematics	MH
Business	BA	Mathematics	MI
Business	BB	Mathematics	MJ
Computer Science	CA	Mathematics	MK
Computer Science	CB	Mathematics	ML
Educational	01	Mathematics	MM
Educational	02	Mathematics	MN
Educational	03	Max Subroutines	99
Educational	04	Miscellaneous	MS
Educational	05	Miscellaneous	MT
English	EA	Science	SA
English	EB	Science	SB
English	EC	Science	SC
English	ED	Science	SD
English	EE	Science	SE
English	EF	Science	SF
English	EG	Science	SG
English	EH	Science	SH
Francais	AF	Technology	TA
Games	GB	Technology	TB
Games	GC	Utilities	UA
Games	GE		
Games	GF		
Geography	RA		
Geography	RB		
History	HA		
Mathematics	MA		
Mathematics	MC		
Mathematics	MD		
Mathematics	ME		
Mathematics	MF		
Mathematics	MG		

I need more Information!

No problem. Send the form below with NO MONEY and we will add you to our mailing list. Next month we're sending out a catalog crammed with goodies too hot to mention on these pages!

Call Us for top prices on blank disks, stationary, and office products.

Phone (02)808 1860.

*Limited Offer : Single Sided Single Density Blank Disks
in packets of ten, with labels and write protect tabs. NO DISK
BOX YOU WON'T USE!! - Price not to be beaten - \$18.95.*

*Reflex Photo Copy Paper - Great for friction feed printer on
screen dumps, letters or even for photocopying! -
Box of 500 Sheets only \$15.00.*

Detach and send to : **Public Domain Software, 19a Frederick Street, Putney 2112**
 Name.....Address.....
Post Code.....
 Daytime Phone.....Disk Required.....
Cheque or Money Orders Only payable to Saturday Computer Services!
Call (02) 808 1860 Now to reserve your order.

Part 1

Machine Code Tutorial

Andrew Baines opens up the world of binary and other mysteries in this, the first of his regular tutorials on the subject.

IF you're tired of the speed of BASIC, maybe you should start programming in machine code!

One of the first questions that should be asked is what is machine code? When you sit down and write a BASIC program, the operating system is flashing the cursor and putting what you type on the screen.

This is all done in machine code, the language the machine (in our case the 6502/6510/8510 micro-processor) understands. Upon running your BASIC program, the computer looks at the first command and performs it by looking up the memory location for the command in a table and jumping to that location.

All of this is done in machine code, but things become bogged down when the '64 looks up the table.

Also string handling is a very complex and tedious task that takes considerable time.

The other way out is to obtain a good compiler like BLITZ and have your programs interpreted, all ready to run at blow-your-socks-off speeds. But this still isn't as good as pure machine code, which is faster yet.

Before we start learning the first few instructions of machine code, there are two other things which must be mentioned.

The first is that to program in machine language you must have an assembler.

The assembler will convert the 'mneumonics' (a big word for symbols) into the numbers that the 65XX can understand. Once a program is assembled in memory we can only understand it if it is disassembled back into mneumonics.

Eg: The instruction LDA #0 will be assembled as 169,0. When we disassemble

it, it will be displayed as LDA #0 again.

Mneumonics are used so we don't have to remember all the different numbers.

The second item to be devoured is Hex.

Most machine code programmers use a different number system called HEXADECIMAL. It is the base 16 number system. It is used because in hex there are only two digits needed to represent 256 different numbers.

Therefore, the first digit represents the first four bits of a byte, and the second digit represents the second 'nybble' of four bits in the byte.

In this way it is much easier to convert binary numbers into something more readable.

Table 1 shows the conversions from decimal to hex (this is the shortened version of the word HEXADECIMAL), and Table 2 shows a complete conversion for all numbers up to 65535.

You might have noticed that letters are used after we run out of the normal digits used in decimal. To indicate to your assembler that you are using hex, place a '\$' in front of each hex number.

Most disassemblies will print in hex numbers, although some still stick to decimal. If you're an accomplished BASIC programmer, the best way to start is to learn the parallels between the two languages.

Table 3 shows these; you shouldn't have any problem with them. To use the logical operators listed in Table 1, we must have two numbers to operate with.

We could put one next to the instruction, but where is the other going to go? You might have noticed that the logical OR's syntax is actually ORA. The 'A' is

the accumulator, one of the registers found in 65XX processors. The accumulator is the register capable of mathematical functions. NO OTHER REGISTER CAN PERFORM MATHEMATICAL FUNCTIONS.

The accumulator is the main register: it is used the most. How do we put numbers into it? By using the Load the Accumulator instruction, LDA. This must have a number or memory location after it.

The other command essential to the accumulator's use is the Store the Accumulator command: STA. This can only have a memory location after it. That's a lot to swallow in one paragraph, so we'll look at an example.

To change the screen colour to black, we must Load the Accumulator with zero, the number for black, and Store the Accumulator in the memory location 53281, the screen colour.

LDA #0

Load the Accumulator with the value zero. The # in the statement means a value follows, as opposed to a memory loca-

Decimal	Hexadecimal	Binary
0	= 0	= 0000
1	= 1	= 0001
2	= 2	= 0010
3	= 3	= 0011
4	= 4	= 0100
5	= 5	= 0101
6	= 6	= 0110
7	= 7	= 0111
8	= 8	= 1000
9	= 9	= 1001
10	= A	= 1010
11	= B	= 1011
12	= C	= 1100
13	= D	= 1101
14	= E	= 1110
15	= F	= 1111

Table 1

TABLE 2 - Decimal to Hex

Hexadecimal conversion table

	0	1	2	3	4	5	6	7	8	9	A	B	C	D	E	F	00	000
0/	0	1	2	3	4	5	6	7	8	9	10	11	12	13	14	15	0	0
1/	16	17	18	19	20	21	22	23	24	25	26	27	28	29	30	31	256	4096
2/	32	33	34	35	36	37	38	39	40	41	42	43	44	45	46	47	512	8192
3/	48	49	50	51	52	53	54	55	56	57	58	59	60	61	62	63	768	12288
4/	64	65	66	67	68	69	70	71	72	73	74	75	76	77	78	79	1024	16384
5/	80	81	82	83	84	85	86	87	88	89	90	91	92	93	94	95	1280	20480
6/	96	97	98	99	100	101	102	103	104	105	106	107	108	109	110	111	1536	24576
7/	112	113	114	115	116	117	118	119	120	121	122	123	124	125	126	127	1792	28672
8/	128	129	130	131	132	133	134	135	136	137	138	139	140	141	142	143	2048	32768
9/	144	145	146	147	148	149	150	151	152	153	154	155	156	157	158	159	2304	36864
A/	160	161	162	163	164	165	166	167	168	169	170	171	172	173	174	175	2560	40960
B/	176	177	178	179	180	181	182	183	184	185	186	187	188	189	190	191	2816	45056
C/	192	193	194	195	196	197	198	199	200	201	202	203	204	205	206	207	3072	49152
D/	208	209	210	211	212	213	214	215	216	217	218	219	220	221	222	223	3328	53248
E/	224	225	226	227	228	229	230	231	232	233	234	235	236	237	238	239	3584	57344
F/	240	241	242	243	244	245	246	247	248	249	250	251	252	253	254	255	3840	61440

Table 2

tion.

STA 53281

STore the Accumulator in the VIC Chip's memory location for screen colour.

After this is complete, the screen will have turned black, and the accumulator will still have the value zero in it - it remains unchanged. So we can STore the Accumulator in the border register.

STA 53280

STore the Accumulator in the VIC Chip's memory location for border colour.

Now the screen and border are both black.

Remember the BASIC command for changing the border & screen colours?

POKE53281,0:POKE53280

,0

Almost the same, isn't it.

The only difference is that we have to load a register with the desired colour and then save or store it in the memory location.

Let's try another example.

In this routine we will position sprite 0 at X=100, Y=100, set its colour to red (2) and turn it on.

First we have to set its pointer to page 200 (or any page, it doesn't really matter).

LDA #200

LoaD the Accumulator with the desired page number; we'll use 200.

where we want the sprite.

STA 53248

STore the Accumulator in the sprite 0 X position.

STA 53249

STore the Accumulator in the sprite 0 Y position. We can do this because the accumulator has not changed from when it was loaded with the value 100.

One more thing before we turn sprite 0 on. Because we want sprite 0 to appear on the left hand side of the screen, we will have to clear the MSB (Most Significant Bit) of sprite 0.

STA 2040

STore the Accumulator in the pointer to sprite 0, 2040.

Next we'll set sprite 0's colour and position.

LDA #2

LoaD the Accumulator with the value 2, which represents red.

STA 53287

STore the Accumulator in sprite 0's location for colour, 53287.

LDA #100

LoaD the Accumulator with the value 100; this is

In this example we will clear all the sprite's MSBs.

LDA #0

LoaD the Accumulator with the value zero.

STA 53264

STore the Accumulator in the sprite's MSB location.

Now we are ready to turn on sprite 0. If you are good at programming sprites, this will be no problem. If you are a beginner, you may have problems in this area.

To calculate the value to be stored in the sprite enable memory location we have to raise two to the power of the sprite number. We want to turn on sprite 0. So we will raise $2^0=1$. 1 is the value to turn on other sprites, you have to perform this calculation for EACH sprite and add the results to obtain your answer. For now, we only want the value 1.

LDA #1

LoaD the Accumulator with the value 1.

STA 53269

STore the Accumulator in the memory location 53269 - the sprite enable location. To finish we will have to perform an RTS (ReTurn from Subroutine) instruction to return to BASIC.

RTS

One more thing - none of the routines presented can be run from BASIC. You will have to obtain a good assembler/monitor.

PAL is a very good assembler, and there are plenty of good monitors available.

Next month - a more detailed look at hexadecimal and the X and Y registers.

TABLE 3 - Basic & Machine Code Parallels

BASIC COMMAND	MACHINE CODE
GO TO(line)	= JMP(memory location)
This command will cause the program at (memory location) to be executed.	
GOSUB(line)	= JSR(memory location)
This command will execute the program at (memory location) until a Return from Subroutine (RTS) instruction is encountered. Then the instruction after the JSR will be executed.	
(a)AND(b)	= AND(b)
where (a) and (b) are the variables to be operated with. Logical AND with the contents of the accumulator, leaving the result in the accumulator.	
(a)OR(b)	= ORA(b)
where (a) and (b) are the variables to be operated with. Logical OR with the Accumulator, leaving the result in the accumulator.	
RETURN	= RTS
Return from Subroutine - used at the end of a program or subroutine to go back to the caller.	
REM(remarks)	= NOP
These two are almost the same in that they are both time wasters. NOP means no Operation. It does nothing, except waste time. The REM statement wastes time, but it also lets you put remarks on your programs - NOP will not let you do this. NOP is simply there to waste time.	

Table 3

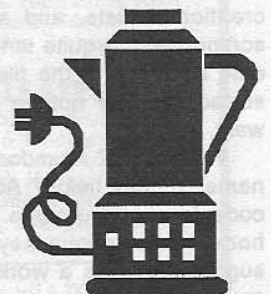

The super page

by Paul Blair

Some more Superbase (SB) this month. I'm finding that a lot of users out there are mastering the standard menu system in SB quite well, and want to move on to do some programming for themselves. That's the next article, but before that, I think it might be a good time to do some revision, and write a few words about key fields.

LIKE any filing system, there has to be a key to every record - some method of ordering the records so that the information can be found and used again. Even a simple card index needs order, and so does SB.

The idea of a key is simple, and the notes provided in Dr Bruce Hunt's book about SB are worthy of study. I don't plan to repeat what he says, just add a few observations of my own.

At a guess, about 75 per cent of SB use is for names and addresses, with maybe some other information as well. And I would stick my neck out even further and suppose that most processing (entry of information, ordering, printing and so on) has some basis built on the use of surnames or maybe business names. There will be some that don't fit this description - I know of one SB user whose databases have postcodes as their principal theme, because he is into geographic/demographic studies, and postcodes best suit his filing needs.

But the use of surnames etc as key fields has an inbuilt problem. In a nutshell, there are often a number of duplicate surnames. In SB terms, this would mean having to elect to permit duplicate key fields. That's not bad in itself, but it does slow down some functions, e.g., creation of lists, and sorting. In fact, sorting can get quite tangled up if duplicate keys are in the file. The resulting sorted list may not be quite what you want.

What to do? Abandon the use of surnames as key fields? Add some sort of code to each surname, and so create home-made unique keys? Bruce Hunt suggests this as a work-around, and it could suit the design of your database.

But remember this - simplicity is paramount, because the whole idea of using a database program is ease of entry and subsequent retrieval. To keep brain work to a minimum, I prefer "intuitive" key fields, because the more natural the key, the easier your operation of the program will be. For that reason, I personally prefer not to use codes or index numbers in a database that is to record details about people. Heaven knows, Big Brother is close enough ...

So I prefer to use surnames. I might not be able to remember all the names, or even spell them correctly, but I can have a guess, try some phonetic spelling, and get pretty close to target. But numbers! I could spend all night trying to find someone in a big file. MATCH is always there, but if the surname is not a key field, then MATCH can be very slow.

“At a guess, about 75 per cent of SB use is for names and addresses, but the use of surnames etc as key fields has an inbuilt problem.”

At the cost of some storage space and speed when storing and sorting, I have used this next trick quite happily for some time. There are two variations, but both use the surname and initials of the "person" to be stored in the file as the "key".

Type 1 is the most compact. W F THOMAS would become "THOMAS W F" in my key field. This gives the fastest speed for nearly all later uses - listing, sorting and so on. But it is clumsier when

it comes to output, especially mailing labels, club lists and so on, because I have to mess around a bit to move the "W F" back to its rightful place in front of THOMAS. It's not difficult, but it has to be thought of. The "&" truncation is very useful here.

I prefer my Type 2, although it does run a bit slower. In this type, I enter my key field as "THOMAS W F". The next entry, A N TAMPICO, would become "TAMPICO A N". The initials would always start at some selected fixed point, regardless of the number of characters in the surname. So we would eventually have:

```
ANGUS      GB
TAMPICO    AN
THOMAS     WF
... and so on.
```

The wasted space is my only real concern, particularly if I'm trying to cram more stuff onto a disk. But formatting output is now a breeze, because I need only slice the last three characters off the back of the key field and add them to the front portion (I know its length - it's the key field length minus 3) and I have a simple format done. That suits me - it might not suit you, but you should think about these things when designing your next database, because ease of use has to be designed in by you. It is in your own interest, isn't it?

BUT IF YOU DON'T.....Index codes DO have a place. I can think of all sorts of uses of, say, a four digit code as a key field. My problem (one of them, anyway!!) is to remember which number I used last.

DUMP is a handy way to overcome this. Let me show you with an example. I will also give you a use for the CHECK command.

Suppose you plan to use four digits as the key field. The first index would be "0001", then "0002" etc. The number could be part numbers, invoices or whatever you want. The leading zeroes are

there to preserve order, because SB will sort invoice 16 ahead of invoice 2 if you don't include them.

The program works by reading a small file named "INDEX" from disk, which holds the last number used. It then adds one to the number, puts the number into the new key field, and waits for you to enter whatever else has to be entered. First, let's set up our little file. In direct mode (on the command line), type the following, then press RETURN
CLR:A\$="0000":DUMP"0:INDEX"

With our index initialized, this is how we would program SB to (1) read the last number used, use it to get the new data, and re-store the most recent number on disk

```
*in4
90 REM: "KEYNAME" IS A KEY FIELD IN
MAIN FILE
100 SET"INDEX"
110 A=VAL(A$
)120
A=A+1:A$=RIGHT$(STR$(10000+A),4)
130CHECK"[KEYNAME]":DISPLAY"WRO
NG FILE":WAIT:FILE:RUN
140CLEAR:[KEYNAME]=A$:STORE:SEL
ECT A$:SELECT R
150 DUMP"0:INDEX"
160
ASK"CONTINUEABORT";Z$:IFZ$="C"TH
E110
```

170 MENU*in

Not long or difficult, but very handy. Next issue we will look at creating your own menu for the C64/C128. T

his can really make for tidy use of SB, especially if you are writing some routines for someone else. POKE'ing Superbase though both the SUPERBASE manual and SUPERBASE-THE BOOK suggest that the POKE command is disallowed, I have found that there is a way to use it. This came about because a friend backs-up his SB data disks on his C64/8250 combination using a purpose written program which transposes files for him - today's summary becomes tomorrow's starting balance, and so on. But in so doing, the system waits for him to answer 'y' at just enough places to be tiresome. How to fix it?

The answer is simple - before (note - before) the line that requests confirmation as part of an internal process, POKE 'y' and a carriage return into the keyboard buffer. How? Answer - use PERFORM (or DO if you have an earlier version of SB) and there is no need for the program to pause.

Try this little example:

```
*in4
10 REM: DEMO OF POKE IN SUPER-
BASE WITH DO/PERFORM
```

20 REM: THIS EXAMPLE ANSWERS "Y" (ASCII 89)

30 REM: NOTE THAT REM CAN BE USED ON SAME LINE AS PERFORM

40 REM: FOR C128 WITH C64 VALUES SHOWN

50 REM: PAUL BLAIR MAY 87

60 PERFORM "POKE 842,89":

REM 631 IN C64

70 PERFORM "POKE 843,13":REM 632 IN C64

80 PERFORM "POKE 208,2":REM 198 IN C64

90 ASK @2,2"WHICH ONE ";A\$

100 DISPLAY @2,4 A\$:WAIT

*in

Of course, there are probably thousands of other ways of using POKE. But be careful - unless you know every little last thing about how SB stores things, you could clobber some vital location. TEST FIRST!

By the way, I transpose routines into upper case for publishing reasons - I think it's easier to read. For the most part, the SB Program Writer is in lower case. Just type what you see, and put capital letters where they seem appropriate. Next month I'll try lower case - if you have a preference, let me know.

UPPER YARRA VALLEY & LILYDALE COMPUTERS

7 Castella Street, Lilydale, Vic 3140
Phone: (03) 735 3734

We stock:-

- * Commodore Computers
- * Wide range of software
- * Joysticks
- * Disks
- * Latest Games

and Micro Accessories products

Everything you need for your computer at a reasonable price and with friendly service.

NASHUA DISKETTES CHEAPEST IN TOWN

5 1/4 DSDD \$17.50 + P. & P.

3 1/2 DSDD \$39.00 + P. & P.

Quad Density and 8 inch call

Printer ribbons made like new

I will re-ink your old fabric ribbons for less than half the price of new ones!
e.g. Epson \$4.00 + P&P

Phone Now

9 a.m. to 5 p.m. (047) 36 3364
After 5.30 p.m. (02) 636 2080

AMIGA PC 10/20 (IBM COMPATIBLE) COMMODORE 128 COMMODORE 64

Specialising in all Commodore hardware and software requirements.

UNITED COMPUTERS:

991 Stanley St, East Brisbane 4169
(07) 393 0300

COMPUTER VIEW: 21 Brisbane Rd, Bundamba, Ipswich 4304 (07) 282 6233

SCARBOROUGH FAIR

COMPUTER CENTRE: Shop 17, Scarborough Fair Shopping World, Southport 4215. (075) 32 5133

DICE ROLLER

by Andrew Baines

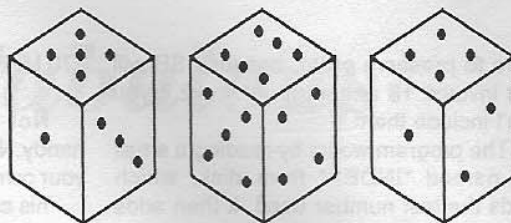

THIS short program (the data is the long part) will display, in large sprites, your roll of the dice. The individual dice rolls can be seen as text, and the total is the sprites.

Type in Listing 1 and save it. The second program to be typed and saved is the actual dice program itself (listing 2). Finally, the data has to be typed & saved. When you run, the data itself will be saved, if all is well.

If you wish to design your own sprites to save time typing, make pages 200-209 the numbers 0-9 respectively: eg page 205 has the data for the number 5.

Don't type in line 45 if your sprites are not multicolour.

To start, load the small program and run it (the other basic program must be named 'dice m'). It will load the sprite data from disk and the actual roller itself. To roll your dice, press the space bar. If your game is too far from the '64, then change line 65 to read:

```
65 J=PEEK (56320) :IF J=127 THEN
65
```

This changes the signal to roll to a joystick in port two. Moving the joystick in any direction, including pressing fire, will result in a roll occurring.

HOW IT WORKS - the loader

The first line checks to see if the sprite data is in memory, and if not, will load it.

Line 5 sets the border and screen to black. Now the interesting part!

In the '64, there are ten memory locations set aside as a keyboard queue or buffer. This is used so the machine doesn't lose any of the information entered at the keyboard. It works by you typing a key, and the value representing that key is put into the queue through interrupts. Next time the computer wants some input, it looks in the keyboard queue and finds what you typed there. But if you typed more than ten characters, the computer loses some, so you

have to start again. This is no great problem, except where you have an extremely slow piece of software.

The keyboard queue uses memory locations 631 to 640 and 198 for holding its length.

So if we put 3 CHR\$(13)'s (returns) in the queue, and we don't use the INPUT or GET or equivalent instructions to retrieve keys from the queue, whatever is on the screen will be entered, just like if you press return to enter 'run'. That is what the next line does. Then we print the commands on the screen (you won't see them because they're printed the same colour as the screen) and end the program, making sure that the cursor will fall in the right positions after every instruction.

Using this method, the program is loaded and run, all without the user having to do anything, or see anything.

HOW IT WORKS - the roller

Line 0 (yes, you can have line 0) pokes the screen black, just in case you stop the program to have a fiddle and the screen colours are not your favourite so you change them.

In line 1, the request is made for the number of dice to be rolled at once. Line 2 checks to see if you've tried to hang the program by giving it bad data, and if you have, it goes back to line 1. Lines 4 & 5 print the title, and line 6 makes lines 4 & 5 a subroutine if 'RE' is larger than zero, which at the beginning of the program is not so. The next part is the part where we set up the sprites. To set up a sprite, we have to:-

- (a) set the position on the screen of the sprite
- (b) set the colour of the sprite (and the multicolour registers if required)
- (c) set state of the sprite
 - (1) multicolour/high resolution
 - (2) the size (whether or not you want it expanded)
- (d) set the sprite pointers. To set the

position on the screen, we must access two bytes and one bit for each sprite. These locations are:-

```
$D000 53248 Sprite 0 X position
$D001 53249 Sprite 0 Y position
$D002 53250 Sprite 1 X position
$D003 53251 Sprite 1 Y position
$D004 53252 Sprite 2 X position
$D005 53253 Sprite 2 Y position
$D006 53254 Sprite 3 X position
$D007 53255 Sprite 3 Y position
$D008 53256 Sprite 4 X position
$D009 53257 Sprite 4 Y position
$D00A 53258 Sprite 5 X position
$D00B 53259 Sprite 5 Y position
$D00C 53260 Sprite 6 X position
$D00D 53261 Sprite 6 Y position
$D00E 53262 Sprite 7 X position
$D00F 53263 Sprite 7 Y position
$D010 53264 MSB sprite X position
```

The Commodore 64 has 320 X-locations where sprites can be. Since one location can only hold 256 different combinations, we use an extra bit.

The location listed has one bit in it for every sprite. If that bit is on (set to 1) the sprite will be over in the far right of the screen (256-320). If it is off, the sprite will be in the left of the screen (0-256). Note that if you position your sprites too far to one side of the screen, they will disappear under the border. To solve this, Andrew Farrell has been on the 64 behind me for the past three days and he has just managed to make a sprite appear in the border, and has come up with some interesting effects in the process.

Sprite colours are exactly the same as screen or border colours, and the relevant locations appear below:-

```
$D025 53285 Sprite multicolour register
0
$D026 53286 Sprite multicolour register
1
$D027 53287 Sprite 0 colour
$D028 53288 Sprite 1 colour
$D029 53289 Sprite 2 colour
```

```

1 ifpeek(12802)<>84thenload"numbers mult
i",8,1
5 poke53280,0:poke53281,0
10 poke198,3:poke631,13:poke632,13:poke6
33,13
20 print"[CLR][BLK]"
30 print"[DOWN][DOWN]poke52,50:poke56,50
:poke642,8:poke44,8:poke2048,0:new"
40 print"[DOWN][DOWN]load"+chr$(34)+"dic
e m"+chr$(34)+"",8"
50 print"[DOWN][DOWN][DOWN][DOWN]run":pr
int"[HOME][BLK]":new

ready.

MAIN PROGRAM

0 poke53280,0:poke53281,0
1 print"[CLR][GRN] how many dice at once
(1-165)":inputn
2 if(n<1)or(n>166)then1
4 print"[CLR][DOWN][DOWN][DOWN][DOWN][YE
L] [C@][C@][C@][C@][C@][C@][C@][C@][
C@][C@][C@][C@][C@][C@][C@][C@]"
5 print" [RVDF] the dice roller
[RVDF]"
6 ifrethenreturn
10 poke53248,88:poke53250,138:poke53252,
188
20 poke53249,135:poke53251,135:poke53253
,135
30 poke53264,0:poke2040,200:poke2041,200
:poke2042,200
40 poke53287,2:poke53288,2:poke53289,2
45 poke53276,7:poke53285,12:poke53286,11
50 poke53277,255:poke53271,255
60 poke53269,7
65 geta$:ifa$=""then65
66 ifa$="[F1]"thenrun
70 gosub200
75 poke53269,0
80 b$=str$(a):poke2040,200:poke2041,200:
poke2042,200
85 b$=right$(b$,len(b$)-1)
87 iflen(b$)<3thenb$="0"+b$:goto87
90 fori=1tolen(b$)
100 poke2039+i,200+val(mid$(b$,i,1))
110 next
115 poke53269,7
120 goto65
200 re=1:gosub4:print"[HOME][DOWN][DOWN]
[DOWN][DOWN][DOWN][DOWN][DOWN][DOWN][D
OWN][DOWN]":a=0
210 fori=1ton
220 b=int(6#rnd(1))+1
230 printb,:a=a+b:next:return

ready.
10 i=12800
20 read a:if a=256 then 40
25 ch=ch+a
30 poke i,a:i=i+1:goto 20
40 ifch<>109443thenprint"error in data":
end
50 open15,8,15,"10"
60 open3,8,1,"0:numbers multi,p,w"
70 poke157,128:poke251,0:poke252,50
80 poke780,251:poke781,198:poke782,52
90 sys65496:close3:close15:end
12800 data 85,85,84,127,255,254,127,255
12808 data 254,127,255,254,127,255,254,1
27
12816 data 255,254,127,255,254,127,255,2
54
12824 data 127,255,254,126,170,126,126,0
12832 data 126,125,85,126,127,255,254,12
7
12840 data 255,254,127,255,254,127,255,2
54
12848 data 127,255,254,127,255,254,127,2
55
12856 data 254,127,255,254,42,170,170,25
5
12864 data 1,85,0,1,255,128,1,255
12872 data 128,1,255,128,1,255,128,1
12880 data 255,128,1,255,128,1,255,128
12888 data 1,255,128,1,255,128,1,255
12896 data 128,1,255,128,1,255,128,1
12904 data 255,128,1,255,128,1,255,128
12912 data 1,255,128,1,255,128,1,255
12920 data 128,1,255,128,0,170,128,255
12928 data 85,85,84,127,255,254,127,255
12936 data 254,127,255,254,127,255,254,4
2
12944 data 170,126,0,0,126,85,85,126
12952 data 127,255,254,127,255,254,127,2
55
12960 data 254,127,255,254,127,255,254,1
26
12968 data 170,170,126,0,0,125,85,84
12976 data 127,255,254,127,255,254,127,2
55
12984 data 254,127,255,254,42,170,170,25
5
12992 data 85,85,84,127,255,254,127,255
13000 data 254,127,255,254,127,255,254,4
2
13008 data 169,254,0,1,254,85,85,254
13016 data 127,255,254,127,255,254,127,2
55
13024 data 254,127,255,254,127,255,254,4
2
13032 data 169,254,0,1,254,85,85,254
13040 data 127,255,254,127,255,254,127,2
55
13048 data 254,127,255,254,42,170,170,25
5
13056 data 84,0,84,126,0,126,126,0
13064 data 126,126,0,126,126,0,126,126
13072 data 0,126,125,85,126,127,255,254
13080 data 127,255,254,127,255,254,127,2
55
13088 data 254,127,255,254,127,255,254,4
2
13096 data 170,126,0,0,126,0,0,126
13104 data 0,0,126,0,0,126,0,0
13112 data 126,0,0,126,0,0,42,255
13120 data 85,85,84,127,255,254,127,255
13128 data 254,127,255,254,127,255,254,1
26
13136 data 170,170,126,0,0,125,85,84
13144 data 127,255,254,127,255,254,127,2
55
13152 data 254,127,255,254,127,255,254,4
2
13160 data 170,126,0,0,126,85,85,126
13168 data 127,255,254,127,255,254,127,2
55
13176 data 254,127,255,254,42,170,170,25
5
13184 data 85,85,84,127,255,254,127,255
13192 data 254,127,255,254,127,255,254,1
27
13200 data 170,170,127,128,0,127,85,84
13208 data 127,255,254,127,255,254,127,2
55
13216 data 254,127,255,254,127,255,254,1
27
13224 data 170,126,127,128,126,127,85,12
6
13232 data 127,255,254,127,255,254,127,2

```

```

55
13240 data 254,127,255,254,42,170,170,25
5
13248 data 85,85,84,127,255,254,127,255
13256 data 254,127,255,254,127,255,254,1
27

13264 data 255,254,42,169,254,0,1,254
13272 data 0,1,254,0,1,254,0,1
13280 data 254,0,1,254,0,1,254,0
13288 data 1,254,0,1,254,0,1,254
13296 data 0,1,254,0,1,254,0,1
13304 data 254,0,1,254,0,0,170,255
13312 data 85,85,84,127,255,254,127,255
13320 data 254,127,255,254,127,255,254,1
26
13328 data 170,126,126,0,126,125,85,126
13336 data 127,255,254,127,255,254,31,25
5
13344 data 248,127,255,254,127,255,254,1
26
13352 data 170,126,126,0,126,125,85,126
13360 data 127,255,254,127,255,254,127,2
55
13368 data 254,127,255,254,42,170,170,25
5
13376 data 85,85,84,127,255,254,127,255
13384 data 254,127,255,254,127,255,254,1
26
13392 data 170,126,126,0,126,125,85,126
13400 data 127,255,254,127,255,254,127,2
55
13408 data 254,127,255,254,127,255,254,4
2
13416 data 170,126,0,0,126,85,85,126
13424 data 127,255,254,127,255,254,127,2
55
13432 data 254,127,255,254,42,170,170,25
5
13440 data 255,255,255,255,255,255,255,2
55
13448 data 255,255,255,254,255,255,255,2
55
13456 data 255,255,255,255,255,255,255,2
55
13464 data 255,255,255,254,255,255,255,2
55
13472 data 24,0,0,0,0,0,0,0
13480 data 0,0,0,1,0,0,0,0
13488 data 0,0,0,0,0,0,0,0
13496 data 0,0,0,1,0,0,0,0
13504 data 255,256

ready.
```

```

$D02A 53290 Sprite 3 colour
$D02B 53291 Sprite 4 colour
$D02C 53292 Sprite 5 colour
$D02D 53293 Sprite 6 colour
$D02E 53294 Sprite 7 colour
```

The multicolour registers only have to be used if you are using multicolour sprites. Otherwise, you can leave them to themselves. To obtain multicolour sprites, this location must be used:-
\$D01C 53276 Multicolour sprite select.

Because there are eight sprites, one bit is used for each sprite. If bit 1 is set to 1, sprite 1 will be multicolour. Multicolour means that you can display four different colours in the one sprite, at a loss of x-resolution. Each sprite's data has 24 pixels across. If the multicolour mode for a sprite is turned on, that sprite's number of pixels will be reduced to 12, but its size will remain the same, meaning you have jagged edges on it. In a normal sprite, if a bit is one, the sprite's colour will be shown. If it is zero, the screen colour (or text if it is there) will be shown.

In a multicolour sprite, there are four possible colours, and to store all these colours two bits must be used in the following pattern:-

- 00 - screen colour (transparent)
- 01 - multicolour 0
- 10 - multicolour 1
- 11 - sprite colour

So when you design your sprite with your sprite editor, instead of being able to control 24 pixels across with 2 colours, you will be able to control 12 pixels across with 4 colours. The jagged edge problem can be solved by putting two sprites in the one place, the lowest number sprite will be displayed on top, so you should make that one high resolution, and the other multicolour and have the top one cover those nasty edges with nice smooth ones.

Expanding sprites is easy. There are two registers required for the two different directions (X and Y):-

```

$D017 53271 Sprite expand in Y-
direction.
$D01D 53277 Sprite expand in X-
direction.
```

These registers work the same way as the multicolour select register: ie if bit 1 is set, sprite 1 is expanded for that direction. Lots of interesting effects can be obtained by using these registers.

The sprite pointers are what stops most people from using sprites. A sprite is 63 bytes long. It is laid out like this:-

```

byte1 byte2 byte3
byte4 byte5 byte6
.....
byte61 byte62 byte63
```

The location of byte one is the location we're interested in. By dividing it by 64, we come up with the page number of the sprite. This number is poked into the sprite pointers at 2040-2047.

Example: You have just designed a sprite, and it starts at location 12288. $12288/64=192$. Therefore, if your sprite is to be sprite 3, POKE2043,192. Most sprite editors display the page number on the screen, saving you calculating it.

```

$07F8 2040 Pointer to sprite 0
$07F9 2041 Pointer to sprite 1
$07FA 2042 Pointer to sprite 2
$07FB 2043 Pointer to sprite 3
$07FC 2044 Pointer to sprite 4
$07FD 2045 Pointer to sprite 5
$07FE 2046 Pointer to sprite 6
$07FF 2047 Pointer to sprite 7
```

On with our program!

Lines 10 and 20 set the positions of the three sprites we will be using. Line 30 sets the Most significant bit of the X-position of all sprites to zero, and sets all the sprite pointers to 200, the area containing the numeral 0. Sprite colour is the next thing we will set, in line 40. Line 45 sets the multicolour for sprites 0, 1 & 2 on, and sets the multicolour registers to two different shades of grey.

In line 50, we make all sprites expand in both directions, and finally in line 60, we turn sprites 0, 1 & 2 on. Line 65 accepts input, and line 66 checks to see if 'F1' was pressed. If it was, RUN. If not, line 70 visits line 200.

This subroutine selects each dice's number through the random function, prints all the individual scores, and tallies them. You might be wondering what the comma in line 230 does. This tells the

computer to print at the next available TAB. These are 0,10,20,30. So next time something is printed, it will sit on the same line as the previous number (unless the previous number was 30) in the next tab position. Example. One number is printed in TAB position 0. The next will be printed on the same line, in tab position 10.

Now that we have calculated the total, we have to put this value on the screen through the sprites.

The variable A holds the total. Line 75 turns the sprites off, so that you can see that a roll has taken place. B\$ is then made from the variable A, and one character is then chopped off from the right of B\$. This is done because the '64 always adds a space to the front of strings. This is not needed in our program, so it is eliminated.

Line 87 makes sure that there is three characters in B\$, even if the first two are '0'. Lines 90-110 poke the pointers with

the proper numbers from B\$+200, and finally, line 115 turns the sprites back on, and the program goes back for another roll.

If you don't understand fully the string handling lines, don't worry, the main point of this program was to demonstrate the use of sprites in areas other than games. If you don't really understand sprites yet, try rereading, its amazing how much you pick up the second time!

Part 1

Basic is easy

Andrew Farrell introduces the world's most popular programming language to budding programmers.

ALMOST all home computers have BASIC built in, or available in some form or other. The Commodore 64 is no exception, with an abstract of Microsoft BASIC ready to run on power up.

BASIC is the language for all of us who use computers. For one thing, it's not unlike English. Many of the commands and statements are easy to understand. They do what it sounds as if they do.

And you don't even need to write a program to try a few of these out. Some commands will work directly. You simply type them straight into the computer and press return.

This is called DIRECT MODE.

Here's a simple example you can try. Switch on your computer and type what you see straight in. The inverted commas are obtained by pressing the shift and two key simultaneously.

```
PRINT "HELLO"
```

Remember to press the RETURN key at the end of the line. You should see the word 'HELLO' printed immediately below what you entered.

The PRINT command you've just used puts text on the screen. Anything between the two inverted commas is printed on the screen exactly as you typed it.

The Commodore has special graphics, symbols and even colour or cursor controls, which may be included in a print statement.

Try this example now:

```
PRINT "GOODNIGHT","HELLO"
```

Notice what's happened? The comma between each set of inverted commas tells the computer to move to the next TAB position before printing. It's possible to use other ways to position text exactly where you want it. That way things don't end up all over the screen.

You can also use the print statement to display numbers.

Try these for style:

```
PRINT 2PRINT 4 + 2PRINT 27/3.
```

You'll notice we used the forward slash in the last line. In BASIC this stands for divided by.

To multiply numbers, use the asterisk symbol. Differences with the examples we've just given you, the computer would have printed 2, 6 and 9. The sums were calculated and the result printed rather than the actual sum.





Notice the difference:

```
PRINT 8*6PRINT "8*6"
```

Without the inverted commas, the numbers are interpreted and the answer calculated. With inverted commas, everything is printed exactly as it appears between the quotes.

Using our examples, as soon as you press RETURN at the end of each line, the BASIC interpreter tries to make sense of what you have typed.

In a program each command is given a line number. This is not interpreted until the computer is ready to deal with that particular entry.

Computers don't speak in BASIC. They much prefer machine language, their native tongue. To us humans, this is nothing more than a meaningless string of zero's and one's.

To help, an interpreter is provided. When you ask the computer to execute a BASIC program or command, the interpreter goes to work. Each instruction must be found in a list. Each part associated with that particular command is fetched. Once all the necessary variables have been located, the whole lot is executed. This process is very time con-

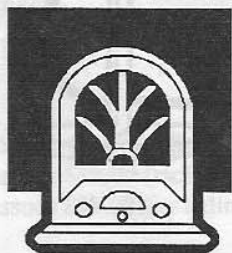

suming and involves a lot of jumping to and fro. Thus, BASIC is very slow.

Games require many different tasks to appear to happen simultaneously. BASIC is just not up to scratch for these types of programs.

However, there's still a lot we can do.

Let's take a look at a few more commands. Earlier on we used PRINT. If we add line numbers, this command becomes more powerful. Enter these lines

into your computer. Remember to press the RETURN or ENTER key at the end of each line.

```
10 PRINT "Hello Bill Pike"
20 GOTO 10
```

The number at the start of each line sets the order in which everything is stored and executed. We can jump to a particular line using the GOTO command. In our example, line 20 simply tells the computer to go back and start again at line 10.

Type RUN to test out your program. You should see the phrase "Hello Bill Pike" appear down the left hand side of the screen. Try using your editing keys to add a semicolon (";") after the last set of inverted commas at the end of line 10. This time your entire screen should fill with the text between the quotation marks.

It's a little awkward to change line 10 whenever we want a different message. Here's a new command to make things easier. INPUT - for getting information into the computer. You can INPUT from the keyboard, disk drive or cassette player.

Normally, BASIC uses the keyboard. To INPUT, we also need a place to store information. By naming this space a small area is set aside ready for use. Since what is contained in these spaces may change, BASIC calls them variables.

```
Here's an example:-
10 INPUT NA$
20 PRINT "Hello "NA$
```

```
30 GOTO 20
```

Now you can enter your name.

Line 20 prints "Hello", followed by whatever you typed. Line 30 jumps back to line 20.

In line 10 we INPUT the variable NA\$. The dollar sign means that the variable may contain text. BASIC sets aside NA\$ in memory and a special pointer says where to store what you enter.

Most versions of BASIC allow you to use meaningful names for variables.

Instead of NA\$ we could have used NAME\$. Only the first two letters are significant when naming a variable. NAME\$ and NAP\$ would be the same.

Variables may also be numeric. Leave off the dollar sign and only a number may be entered into our above example. Here's another example :-

```
AMOUNT = 6C = 2A1 = 2.5
```

Variable names may include numbers after the first letter.

You must not use any special characters such as an exclamation mark. Numeric variable can be added, multiplied, divided or subtracted just like numbers. For example :-

```
C = 2D = 4PRINT C + D
```

Just press return at the end of each line.

You should see the result of 6 displayed above the READY prompt. Ready tells us that the computer has finished, and is ready to go on with something new. Next month, we'll put our knowledge to work and make a small program to calculate times tables.

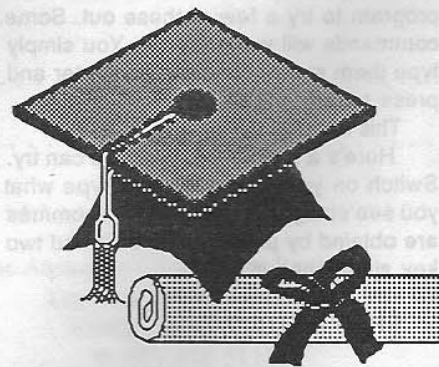

COMMODORE PRINTERS

For every Commodore computer there is a Commodore printer that is designed to cover your specific needs whether you are an owner or user of a Commodore 64 or 128, an AMIGA 500, 1000 or 2000, a PC 5, 10, 20 or 40.

Commodore printers are designed to give you total compatibility with the rest of your computer system with built-in high performance and at the same time offering value for money.



Commodore MPS 1250 Dot Matrix Printer



Commodore DPS 1101 Daisy Wheel

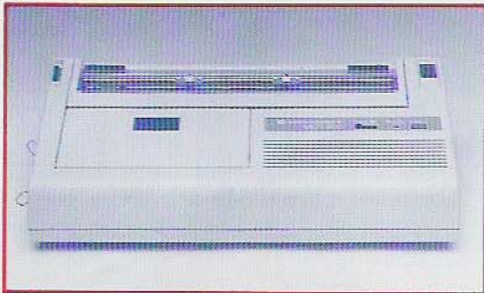

Commodore MCS 810/820 Colour Series

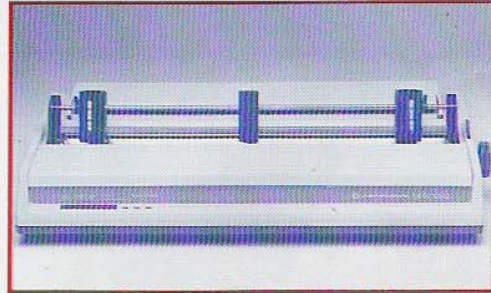

Commodore MPS 1280 Dot Matrix Printer

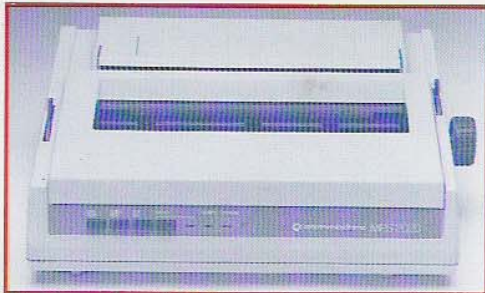

Commodore MPS 2020 Dot Matrix Printer

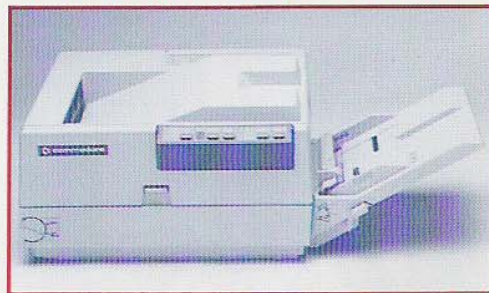

Commodore LP 806 Laser Printer

 **commodore**
COMPUTER

This document was produced on the Commodore LP806 printer.

CARTOON'S MOST
ELUSIVE CHARACTER HAS
FINALLY BEEN TRAPPED.

ROAD RUNNER

THE ARCADE SMASH HIT
THAT RECREATES THE SPEED
AND EXCITEMENT OF THESE
CLASSIC ENCOUNTERS.



Young or old, whatever your age everyone enjoys the antics of the cunning Road Runner as he baffles and bemuses poor Wile E. Coyote. Or does he?...

This is your chance to really find out as you take on the role of Road Runner in this comic, all action extravaganza that recreates these nail biting chases and the fast moving excitement to perfection. Speed through canyons and along the highways following the trail of birdseed left for you to feed on (is this the first trick???) Dodge your way round the onrushing trucks keeping an eye out for the perilous mines and feather ruffling, leg busting oil slicks. What dastardly plans has the sleazy Wile E. Coyote got in store for you as he lurks in hiding, cowardly awaiting his moment to enjoy a succulent roast of "Road Runner and French Fries". We're sure you'll overcome all the dirty tricks he can throw at you with ease, agility and grace and a haughty "Beep Beep". Overcome them that is if you've got nerves of steel, the reflexes of a wildcat and the speed of the fastest bird on two legs, otherwise its sorry, goodnight and "Burp Burp"!!!



Available for **CBM 64/128, ATARI ST
and AMSTRAD** home computers



Distributed by
Ozisoft Pty Ltd
33/8-24 Kippax St,
Surry Hills, NSW, 2010
Ph (02) 211 1266

Distributed by
Ozisoft Pty Ltd
33/8-24 Kippax St,
Surry Hills, NSW, 2010
Ph (02) 211 1266

SCREEN SHOTS FROM ARCADE VERSION.

