

A Gareth Powell Magazine

# The Australian COMMODORE REVIEW

NEWS.00

Review of  
PSI 5  
Trading  
Company

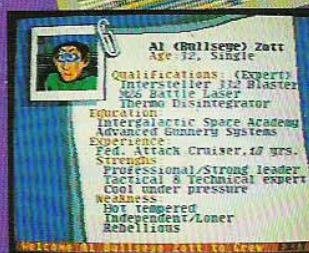

Lots of  
games reviews:  
*Little Computer  
People \* Ball  
Blazer \* Back to  
the Future \* The  
Transformers \*  
Gyroscope \* and  
more*

Report on the Commodore 128  
The SID chip lives on  
Dealing with databases

Amiga News  
More about music  
TED Register description

# Hit List



▲ Fastest selling game in **Electronic Arts** history! Multi award winner.

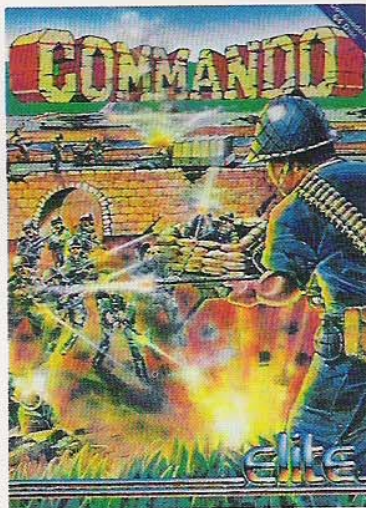

It's a knockout !



◀ The No.1 U.K. Hit

First of the "Tales of the Unknown".



◀ Make Movies for less than \$50.



Have you met the WEEK family?



◀ Why not meet **Wally** and **Herbert** in the first two family adventures? ▶



*Entertaining Australia.*

# ECP

ENTERTAINMENT  
& COMPUTER  
PRODUCTS PTY LTD

3A/3-9 Kenneth Rd., Manly Vale 2093.  
Australia. Phone (02) 949 7300.  
Telex No 176039 ENTCOM

*Please contact your local ECP representative:*

Vic ECP Pty Ltd, 1981 Malvern Road, Malvern East, Vic 3144 Ph (03) 211 8410  
Qld Computronic, 8 Harlequin St, Sunnybank Hills, Qld, 4109. Ph: (07) 273 3398.  
SA Phil Stubbs Agency, 239 McGill Rd, Maylands, SA, 5069. Ph: (08) 332 9827  
WA John Mills Agency, PO Box 278, Greenwood, WA 6024. Ph: (09) 448 1137  
Tas. Tasmanian Record Company, 10 Cameron St, Launceston, Tasmania 7250.  
Ph: (003) 31 5588.

# The Australian COMMODORE REVIEW

Vol 3 No 5 May 1986

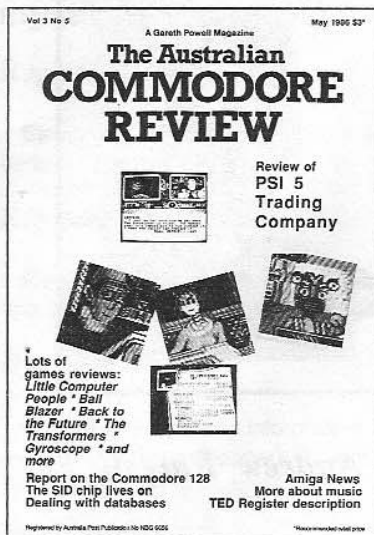

**The Australian  
Commodore Review**  
Top Rear, 4 Carrington Road,  
Randwick, NSW 2031  
Phone: (02) 398 5111

**Published by:**  
Saturday Magazine Pty Ltd

**Publisher:** Gareth Powell

**Editor:** Andrew Farrell

**Advertising Enquiries:**  
Ric Richardson  
or Brenda Powell  
Phone: (02) 398 5111  
Top Rear, 4 Carrington Road,  
Randwick, NSW 2031

**Subscription Manager:**  
Tina Spathos  
Phone: (02) 398 5111

**Distribution:**  
NETWORK

**Printed by:**  
Ian Liddell Commercial Printing

## Contents

### EDITOR'S PAGE

2 Editorial

### NEWS

3 Ram Rumblings

### GAMES

5 Hot Stuff:  
Little Computer  
People  
Mercenary  
Ball Blazer  
PSI 5 Trading Co  
Gyroscope

14 Starcross  
38 Back to the Future  
39 The Transformers

### SOFTWARE

12 Amiga News

### HARDWARE REPORT

16 The First 100 Days  
20 The SID Chip lives  
on

### MUSIC

25 Why you need a  
Computer Aided  
Music System  
28 Passport MIDI  
4+ or 8+

### PROGRAMMING

45 TED Register  
Description

### READERS' QUERIES

33 Adventurers'  
Corner  
48 Commodore User  
Groups

### CP/M

40 Dealing with  
dBase

### HOW TO DO IT

42 What is a database  
file?

# Editorial

Many thanks to those of you who have acted on our request for High Resolution pictures. So far they have been of a high quality. However we still need lots more so please rush in your masterpieces as soon as possible so that they can be included in the special graphics issue some time in the near future.

An apology is in order with regard to the slowness of arrival of our latest disk magazine. Some orders were waiting for an outstanding period of time, a problem which we are now planning against.

Many people are not aware that our disk magazine is in fact produced in a remote part of Alaska by a small group of dedicated workers who have very little contact with the outside world.

Unfortunately during a recent blizzard the entire outpost was buried for a period of three weeks. This hindered matters only slightly compared to the six weeks we had to wait for the delivery of several hundred disks after the transport ship was sunk and a recovery team took four weeks just to locate the wreck.

What's more, four of the divers on the team came down with ear infections and had to stick to a diet of chilli beans and blackcurrant juice. When they finally recovered the disks, only three had survived in machine readable condition. Two of these were suffering from malnutrition and over exposure. The last remaining disk has been several weeks recovering in hospital before returning to normal duties at our duplication plant.



*Andrew Farrell*

And that is why our disk magazine was late. You don't believe it? Well, neither did we; that's the best story we could think up and we're sticking to it.

## DIRECT SUBSCRIPTION

## The Australian COMMODORE REVIEW

*Make sure of getting your copy - take out a subscription now!*

Please enrol me for ..... issues subscription to the Australian Commodore Review, commencing

with the ..... issue. I enclose a cheque/money order for \$ .....

OR my Bankcard number is .....

Name: .....

Address: .....

..... Postcode .....

(Please print in BLOCK letters)

### Rates within Australia:

Subscription rate for 6 issues: \$18.00

Subscription rate for 12 issues: \$36.00

### The Australian Commodore Review

Top Rear, 4 Carrington Road,

Randwick, NSW 2031

# RAM RUMBLINGS

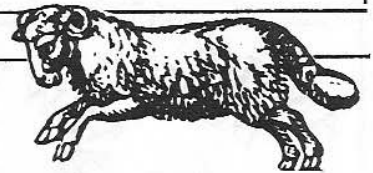

## GATO

submarine simulation

Imagineering has released the watery alternative to the famous *Flight Simulator*, the Commodore 64K-byte version of Spectrum Holobyte's best-selling submarine simulation game, *Gato*.

Set aboard a World War II Gato Class submarine, this graphically advanced game puts the player into the captain's seat for a series of strategic missions as realistic as the real thing, but minus the inconveniences and hazards normally accompanying a submarine adventure.

The Commodore version includes eight missions, five difficulty levels and three ships, and takes advantage of the computer's excellent sound capabilities. Mission assignments are received over the submarine's radio using digitised voice, enemy ships explode and the sonar pings realistically, and your submarine drones as it sinks to the ocean floor.

*Gato* on disk for the Commodore 64 is priced at \$69.95.



## Freeze Frame

A new backup system is available for which the makers say will work on 99% of known software for the Commodore 64 and 128.

Freeze Frame is a cartridge which you plug into your computer. It works like this:

You LOAD and RUN the program you want to back up.

When the program is running you press the button on the Freeze Frame cartridge. After a few seconds you will see a screen with coloured flashing horizontal lines.

At this stage you can do one of three things.

(a) Press 'D' to save a version of the program to disk. This version will include a fast reload routine.

(b) Press 'S' to save a version of the program to disk. This version will reload at normal disk load speed.

(c) Press 'RECORD/PLAY' on your datasette and then press 'T' to save a version to tape. This will include a tape fast reload.

Sounds good. Watch for a test report in our next issue.

Available from Jensen Electronics Pty Ltd, (08) 269 4744.

THE  
**ULTIMATE  
BACKUP**  
for 99%  
of known software for  
**Commodore  
C64»128**



TAPE to TAPE \* TAPE to DISK \* DISK to TAPE \* DISK to DISK

Australian  
distributors:

**Jensen  
Electronics  
Pty Ltd**

75 Prospect Road  
Prospect  
SA 5082

Tel: (08) 269 4744

Trade enquiries  
welcome

**ANTI-KNOCK  
DEVICE**  
**NEW NEW NEW NEW**

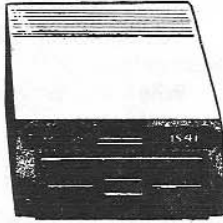

**Eliminate ! !**

**\* Head knock  
\* Drive alignment  
problems  
on your 1541**

**Permanent fixture**

- \* Easily installed by you**
- \* Full instructions**
- \* Set up program included**
- \* Full backup by us**
- \* UK design**

**Only \$24.95**

**plus \$2 P&P**

**BANKCARD AND VISA**

**Trade enquiries welcome**

Watch for:

Freeze Frame Mk II  
Disk Dissector V4.0  
Quickdisk  
Dolphin Dos (25 times loading speed)

**Micro Accessories of S.A.  
39b Anderson Walk  
Smithfield  
SA 5114  
Phone: (08) 254 6284**

*We ship to N.Z. too*

## RAM RUMBLINGS

### Melbourne Shows

Three very interesting shows will be combining in Melbourne in June.

**PC86** - the Seventh Australian Personal Computer Show - has combined with **Communications 86** and a new show, **Office Technology 86**, to bring together the largest range of business equipment ever seen at the Royal Exhibition Building, Melbourne, from 1-4 June.

The combined shows will be opened by visiting hi-tech marketing expert Regis McKenna, who will also give two seminars.

Visitors will also be able to attend The Learning Show, a series of tutorials, seminars, hands-on courses etc.

Sessions on hardware, software, office technology integration computer and communications, modems and the latest trends in personal computer technology are all available during the three business days of the shows.

Products displayed in PC86 include micro computer hardware, software and peripherals. There are many distributors including Commodore, and also software distributors such as Ozi Soft and Imagineering, and printer suppliers such as Epson.

Communications 86 will highlight developments in telecommunications, data communications, videotex and satellite communications.

The show will be open from 10 am to 7 pm, 1 to 3 June and from 10 am to 5 pm Wednesday 4 June.

### Computer Shows Need More Entertainment!

There are too many computer shows - and too many are not worthwhile, according to Commodore Business Machines.

They say the number of computer shows is destroying interest in them - both from the public and exhibitors.

National Advertising & Promotions Manager, Gil Avenaim, says exhibition organisers seem to be trying to "cash in" on what they perceive to be a lucrative new market.



### HOW TO BEAT COMMERCIAL PROTECTION!

As most Commodore owners will have found out over the last year or so, they can no longer back-up their original software. Losing a favourite game title or adventure through repetitive loading is no fun at all, especially considering today's prices for software. And now protection is becoming so complicated that no copier can make back-ups for you. Sometimes you can't even load the program because the protection schemes are so sensitive. Not only do we have these problems to contend with but commercial programs seem to have a unnecessary habit of thrashing the read/write head around on 1541s and compatibles. It's a very sad story for all Commodore 64 owners and we are all at the mercy of the software houses. However, the user maintains the right to modify the original software in such a way that archival back-ups can be made.

Talking about modifying software and carrying out the modifications are two different things. How do you do it? Benson Computers have all the answers with Program Protection Manual I, PPM II, and The Eprom Programmers Guide. These 3 manuals are absolutely essential to the hacker and novice, overflowing with all the information required to break commercial protection schemes and create your own protection schemes.

These manuals take you on a guided tour through your C-64 and 1541. They fully explain the protection schemes that are used for Tapes Cartridges, and Disks, and how to beat them. Just outlining subjects that are discussed in these 3 manuals would take more room than this column allows, however we can give you a taste of a few subjects that are fully explained:- Back tracks & sectors, Long & Short data blocks, Nybble counting, Half tracking, Density switching, Track synchronization, Extra tracks Drive speed variation, Encryption, Interrupts Undocumented op-codes, Eproms, and much, much more...

There are only 25 sets of these manuals available to the public, so don't miss out! Benson Computers sell the set of 3 manuals at a very reasonable price of just \$135. To order phone (03) 534 0994 in Vic. or outside Vic. on 008 334 854.

# HOT STUFF

## Little Computer People Project

For those of us who have had our fill of competitive games filled with wrist flexing action, and who might prefer to watch the activities of an ant farm or the antics of a stick insect instead, *Little Computer People* is a gift and a blessing. Andrew Farrell waited for his little computer person to arrive to file this report.

One reviewer described this game as being flagrantly juvenile, whilst others have spent many long hours mesmerised at the trivial but enthralling pastimes of the newly discovered little computer people.

These chirpy individuals were discovered almost by accident by Activision's Little Computer People Research Group. All those little glitches and hiccups that your computer occasionally suffers have been successfully attributed to the movements of previously unseen people who live inside every computer.

Measuring in at a height of around 1 1/2 inches, it was found that they could

easily be contained within a house constructed inside the computer, where they can then be observed at great length. By using the *Little Computer People* Project software you too can enjoy, after a brief wait, the company of one of these rarely seen creatures.

The program comes well packaged complete with the following items:

- \* The Little Computer People House-on-a-Disk Research Software. This is an exact replica of the original two and a half storey house used by the research team. Activision guarantee that a LCP (Little Computer Person) will be drawn from the dark depths of your computer into residence in this comfortable abode.

- \* The Computer Owners Guide to Care of, and Communication with, Little Computer People. As a responsible member of our society you will be directly accountable for the wellbeing of your LCP once he has moved in. You will need to provide food, water and loving attention. This booklet will help you get your relationship off to a good start.

- \* Deed of Ownership. This allows you to register as an official LCP owner.

- \* Special Edition of Modern Computer People Magazine. A humorous full colour magazine packed with real life reports, history and culture of the Little Computer People.

It all sounds truly ludicrous. Once settled in you can learn about their

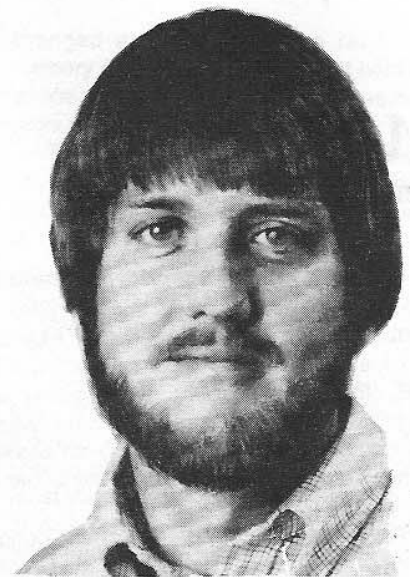

habits, play games with them, give them plenty of TLC or treat them terribly and see what disastrous effects take place.

Now this may not be your idea of excitement or fun. However, the concept behind this game, if it can in fact be called such, is quite unique in itself. Activision claim that the idea is to involve people into simply participating in a game rather than playing to win.

No points are scored or lives lost. A non-competitive theme provides a breath of fresh air from the usual high blood pressure arcade addict's average game. This is not something that everyone will like. You will either love it or hate it.

Cute graphics (definition of cute : ugly but interesting), with some novel approaches to speech synthesis. A few doses of humour and perhaps enough complexity to satisfy the curiosity of some. If all else fails you can try starving your little computer person just for the sadistic pleasure of watching him suffer. But then such unkind hearted people probably wouldn't have the instructions to the game - having pirated their copy - and therefore not know how to indulge in such reckless behaviour.

Distributed by: Imagineering

Price: Disk \$34.95,

Cassette \$19.95



Australian Commodore Review 5

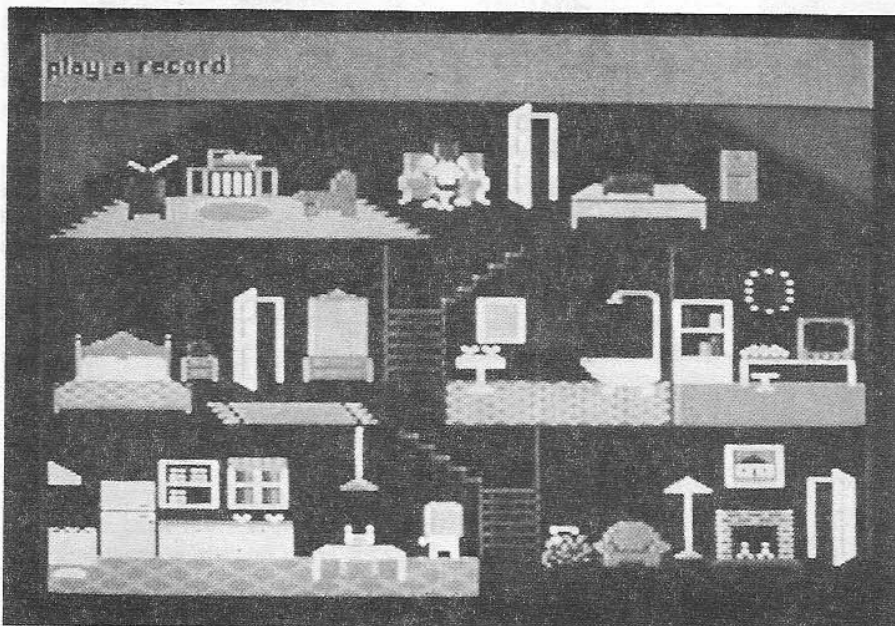



# Mercenary

## Onward and Upward

Message to Mercenary.. located power amp  
 ..found keys ..need more time to explore  
 ..returning to base for more exploration.

Hiya. Still floundering around in your Dominion Dart? Well, stop cruising around at half power and hop along to the place marked on the maps on this page and pick up a few goodies. The power amp is an essential part of the game, allowing access to the Palyar base far above the city below.

After quite a large amount of exploring I have found a network of transporters which allow access to many different parts of the city. They are also mentioned in part in the maps below. Still waiting on reports from other Mercenary players. I hope my maps prove to be accurate. The corridor lengths may not be exact, however the orientation of the doors should be more or less correct.

Have you tried flying the cheese? Of course not, how ridiculous. Well, why not try boarding it just like any other craft? You may be in for a surprise.

Another tip of interest is that the odd shaped doors may be opened, but you need the right keys first. These are found as objects which are the same shape as the doors themselves. You will need these in the Palyar base where some very useful things are to be found.

Also try destroying any of the three billboards around the city for some novel side effects. I still love those graphics, so keep plodding on, until next month happy exploring.

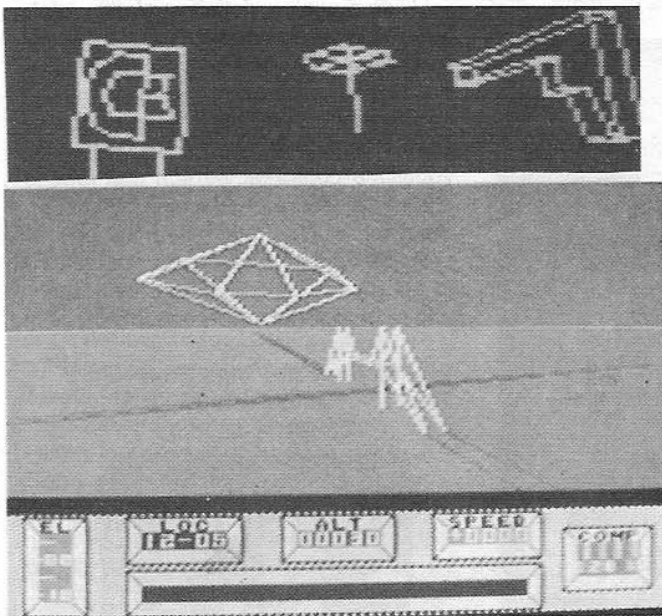

Australian Commodore Review 6

### Palyar Base 81,35

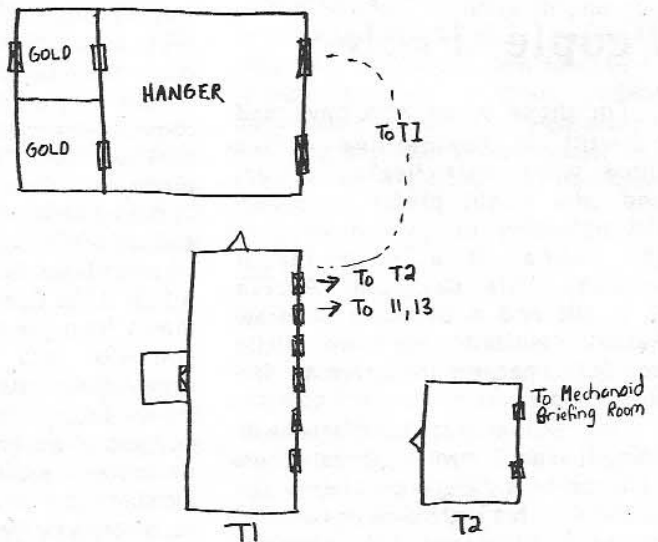

### Palyar Hanger 11,13

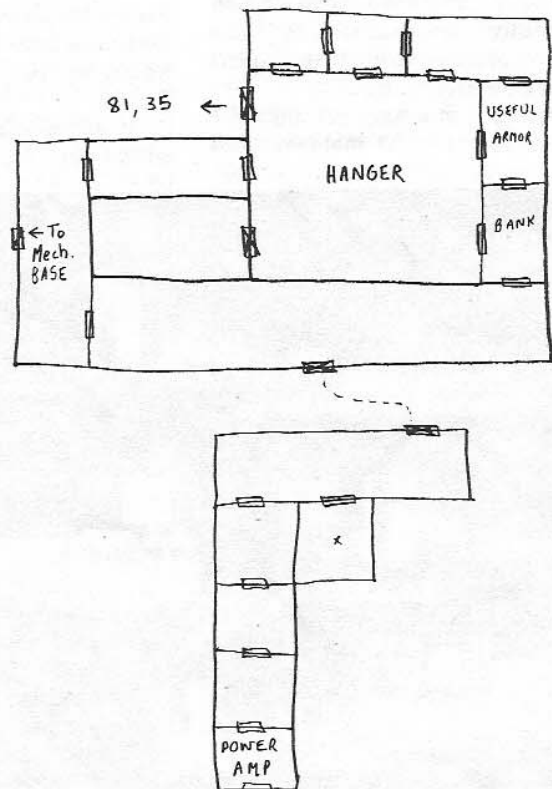



# Ball Blazer

Many years into the future, past the great trade wars of pirating and fighting comes a sport. A sport of lighting reflexes, constant action and only one victor. The sport can be nothing else but *Ball Blazer*.

*Ball Blazer* was derived from ancient military training exercises in which pilots were placed in small spacecraft and subjected to extreme acceleration and deceleration, this was to prepare them for space battle. During this process a few cadets with time on their hands designed a game to play with their spacecraft. The game evolved into a means of ending war and the beginning of peace through friendly competition.

Earth has finally made it to the *Ball Blazer* grand finals. For the first time in our history all of earth is aglow with the thrill that someone is representing their small but significant planet.

This is all very well but what has it got to do with you?

Well, *Ball Blazer* has made its way to the 64, so you battle it out with the Master Blaster of the Universe!... Or perhaps just a friend.

*Ball Blazer* is usually played on a rounded asteroid. The playing field is a long rectangle which appears to be made up of squares so that it looks like a grid. At both ends of the field there are two goal posts each moving left to right on

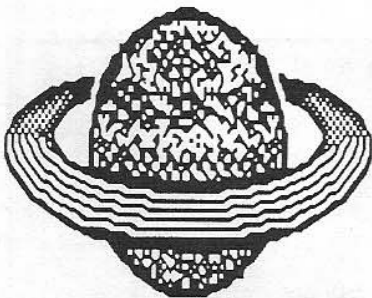

their respective sides. So unless you can see them you can never determine where the goals are at any one time. The ball is pure energy orb and you have one objective, to get the ball through the goal any which way you can.

Both players control a primitive spacecraft that has had the levitation drive taken out. Added to the craft is a powerful forcefield which protects the craft from any damage and also helps to shoot the ball forward. The craft has been appropriately named the Rotofoil.

The Rotofoil has a built in computer which tracks the ball wherever it moves. So wherever you are, regardless of your speed the computer will "snap" the craft in the direction of the ball. This is called "rotosnapping" and can be very confusing to a new player. But after a few games you quickly adjust to the change in direction. If the player gets control of the ball the computer locks onto your goals and turns your craft to face the goals. Then it's up to you to line up and shoot for goal.

Points for goals vary from one point for literally pushing the ball through the goal to three points for shooting the ball over the horizon without seeing the goals. Most games should be played over a three-minute time limit, but you can change the time from a one minute game to ten minutes. Official *Ball Blazer* games must be three minutes.

The viewpoint is totally three dimensional. Everything on the playfield moves in total perspective; it has to be seen to be believed. The programming techniques used must be very advanced as there is a feeling of being there the moment play begins.

Either one or two players can play at a time. This is made possible by split screen techniques a la *Spy Vs Spy* and *Pitstop II*. In one player mode you have a choice of nine droids to play against. Most will find it hard to be droid three or four as they provide a very tough game. But it's the two player mode that makes this game so enjoyable. Two people can play for hours, each game getting progressively better. It just provides so much competition for two people. It's kind of "the one-on one sports simulation" for any computer.

Graphics are bright and crisp. The



scrolling playfield is the smoothest and most realistic I have ever seen on a home computer. You almost come out of your seat as you hurtle down the grid in your tiny craft with only the ball between you and the other player, hell bent on your destruction. The perspective, as I said, is incredible with advanced fractal programming used.

Sound is not as breathtaking but is nevertheless used well and a neat auto-improvised tune is played on the title screen. But, it's graphics and sheer playability that make this game so special.

I originally played *Ball Blazer* on an Atari Micro and I am very happy to say that the 64 version is the better version. It has greater speed and a more challenging one player mode. The game almost plays like an Amiga demonstration. If you needed to showcase the 64's graphics with just one program this is it.

In conclusion Lucasfilm games have a tough act to follow with this game, as it has to be mega-game for '86. In my opinion *Elite* and *Impossible Mission* would be the only other games of equality. Miss it and you're not using your 64's game playing ability to its full potential.

by *Donovan Curver*

Publisher - Activision/  
Lucasfilm games  
Supplier - Imagineering  
Price - Cassette \$29.95  
Disk \$39.95

Presentation:	95%
Sound:	82%
Graphics:	98%
Hookability:	99%
Lastability:	97%
Value for money:	95%
Originality:	91%
Overall:	96%



## PSI 5 Trading Company

A different approach to the Star Trek theme, or something more?

Mercenary themes have proved to be very popular in many computer games. In *PSI 5* you are responsible for the crew and cargo of an inter-galactic transporter. Space travel is a dangerous pastime, as we have recently appreciated, and even in the 35th century it's not without problems. The stars are filled with would be pirates who cruise about the cosmos in search of a worthy bounty.

Thankfully, you are well equipped. Sporting a hand picked crew, whose descriptions are as wide and varied as their talents and experience, you must captain the transporter to your chosen destination and arrive in one piece. If the cargo doesn't arrive intact, you could be up for its value, which may be a rather large sum.

A managerial role is not unlike that which you at first assume. The cartoon like characters who represent your crew members could be mistaken for being human counterparts. They display human qualities such as initiative and frustration. They fiddle and fidget, blink and stretch in a bid to overcome deep space boredom. However, they are not such a useless lot. In fact, without so much as a wave of the finger, they will carry on maintaining all the more mundane aspects of your craft.

Occasionally each one will report in on his or her latest activities. Using the command menu at the centre of the screen, you may select an option with the joystick and also manually control operations. Different jobs may be given a priority rating. For instance repair work may be essential, or perhaps directing energy to fire power or deflectors. Star Trek fans, eat your hearts out, this one takes the cake.

At the top third of the screen, two smaller screens display animated views of happenings about you. The left one gives one of four possible views from your craft. It's rather like having front row seats to your own execution. Yes, you won't

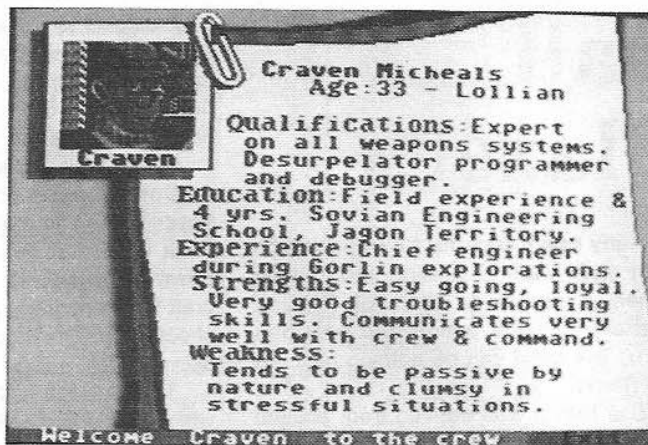

miss one shot as the aliens swoop in, rob you and then blast you and your odd assortment of friends into tiny itty bitty pieces.

The right hand screen gives a head and shoulders view of the character you are presently conversing with. Excellent animation here, with good use of colours. At the screen center is the command line, with each command represented in an abbreviated fashion and selected using the joystick.

Below the command line additional information about your current position is displayed. This includes messages that are continually being relayed to you from the crew members. This is an important facet to the game, as you must encourage the crew to work as a team and be sure to give them plenty to do. As things get hectic you will be surprised how well things operate if the crew have been kept busy always.

Many of them will automatically respond to certain situations. However, a few have minor problems with stress which can make life difficult.

*PSI 5* is a different sort of game. It is by no means a fast paced experience. Nor is it slow and drawn out. Life is more interesting when you do things yourself. If you just sit and wait you will be surely removed from the sky without too much of a warning. By keeping a constant watch you can remain on top of the whole operation.

Simple but effective music surrounds a well presented game with excellent graphics. Overall, perhaps a little too different for some, but bound to appeal to those into this sort of game.

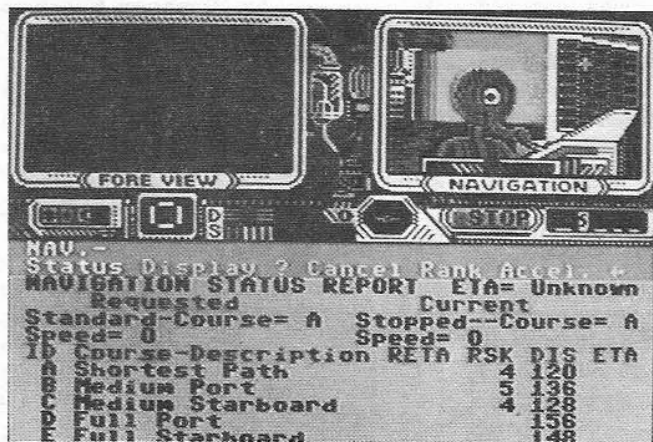

Machine : Commodore 64  
 Publisher : Accolade  
 Distributor : Ozi Soft  
 Price: Cassette \$29.95  
 Disk \$34.95

Graphics :	96
Sound :	86
Originality :	90
Presentation :	90
Addictiveness :	84
Overall :	88

COMMODORE

# Gyroscope

No doubt this game is based on an old arcade classic called *Marble Madness*. A similar three dimensional perspective landscape, that resembles a grid that has been stretched over a bumpy landscape, scrolls smoothly by as you attempt to guide your gyroscope safely through the terrain.

At the end of each frame a small black hole will appear into which you must fall to successfully complete that section. Various nasties make life difficult as the game progresses. However, initially, controlling the gyroscope is a challenge within itself. The joystick proved to be very sensitive, and it wasn't until a certain amount of self control was obtained that I could even stay on the

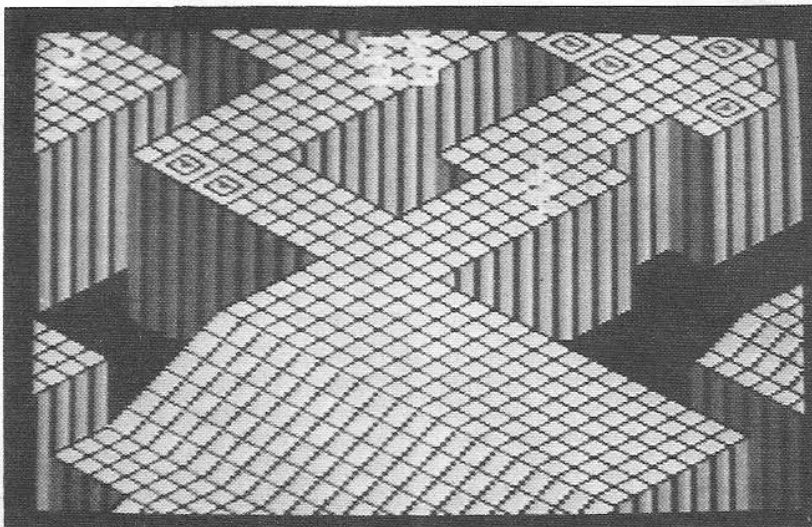

straight and narrow for a brief amount of time.

Some aspects of the gyroscope's

movements proved to be very frustrating. When you run off the edge of the path you're on, the game does not move you



**commodore**  
computer centre

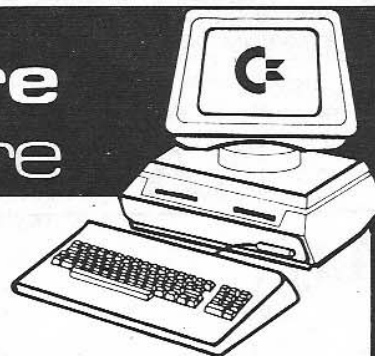

**AMIGA, 128, 64, VIC20  
PC10, PC20 and CBM8000**

LARGE COMPUTER DISPLAY — 3000 SQ FT. • WE ARE THE EXPERTS, COME & SEE US FOR

## SALES

- Every conceivable accessory
- Huge range of programmes (particularly education)
- Direct connect typewriters
- 17 different printers
- Serial & Parallel Interfaces
- Monitors: colour and monochrome
- Touch tablets
- Plotters
- Disk Drives (4 different & includes compatibles)
- Desks, printer stands
- Books, labels, magazines (huge range)

## SERVICE

- Prompt repairs by friendly experts
- Disk drives aligned (specialty)
- Easy access
- Plenty of Parking
- Open Saturday mornings
- Established 1968
- Repairs accepted by mail (include phone number)

**Maxwell**  
OFFICE EQUIPMENT (VIC) PTY. LTD.

162-164 NICHOLSON ST., ABBOTSFORD  
(near Collingwood Town Hall)  
Telephone (03) 419 6811

FOR SPECIAL  
CONCESSION  
BRING  
THIS  
AD

ULTIMA

back on the path before restarting. This can lead to the loss of many lives before you manage to wangle your way back to safety.

Sometimes when I seemed well and truly within the bounds of safety the game pronounced that I had run off the track, whilst other times when I went wildly out of range things continued on happily.

As the screen scrolls by from bottom to top, a musical accompaniment slowly picks up pace. Magnets, strange looking alien forms and well positioned gaps in the path provide increased difficulty later on.

Scoring is based on the time you take to complete each section, with five gyroscopes being available at the start of the game. In all there are some thirty screens, the third of which resembles a giant geometric slippery dip. The gyroscope is only slightly affected by sudden down hill runs, however magnets do have a more dramatic effect.

What appears interesting at first can turn frustrating. However, once mastered *Gyroscope* would quickly bore most arcade addicts. Great music and well thought out graphics. A little more variation would be good, although the presentation cannot really be faulted. Not bad if you like slow moving games, and possess an exceptionally steady hand.

Machine : *Commodore 64*  
Game : *Gyroscope*  
Distributed by : *Melbourne House*  
Price : \$24.95

Graphics: 88  
Sound : 86  
Originality : 82  
Presentation : 86  
Addictiveness : 78  
Overall : 84

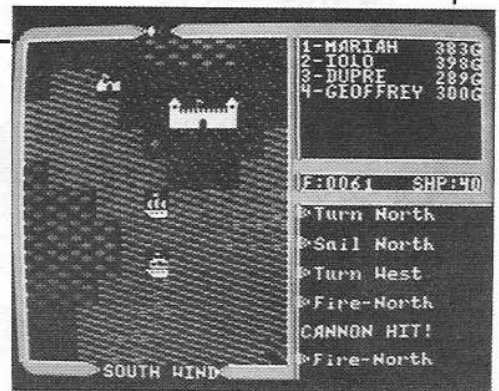

## Ultima IV: Quest of the Avatar

After much success with the earlier Ultima series, Lord British has come up with yet another mammoth addition to the vast world he has created. There is a new plot and further expansion in the character areas. Similar graphics and sound to Ultima III will no doubt continue to impress many.

We hope to have a full review in the near future by one of our dedicated adventurers.

# NATIONAL

May

# TOP TEN

1. Monty on the Run - Melbourne House
2. Commando - ECP
3. Goonies - Ozisoft
4. Rambo - ISD
5. Mercenary - ISD
6. Paradroid - Ozi Soft
7. Elite - ISD
8. Rockford's Revenge - Ozi Soft
9. Skyfox - ECP
10. Winter Games - ECP



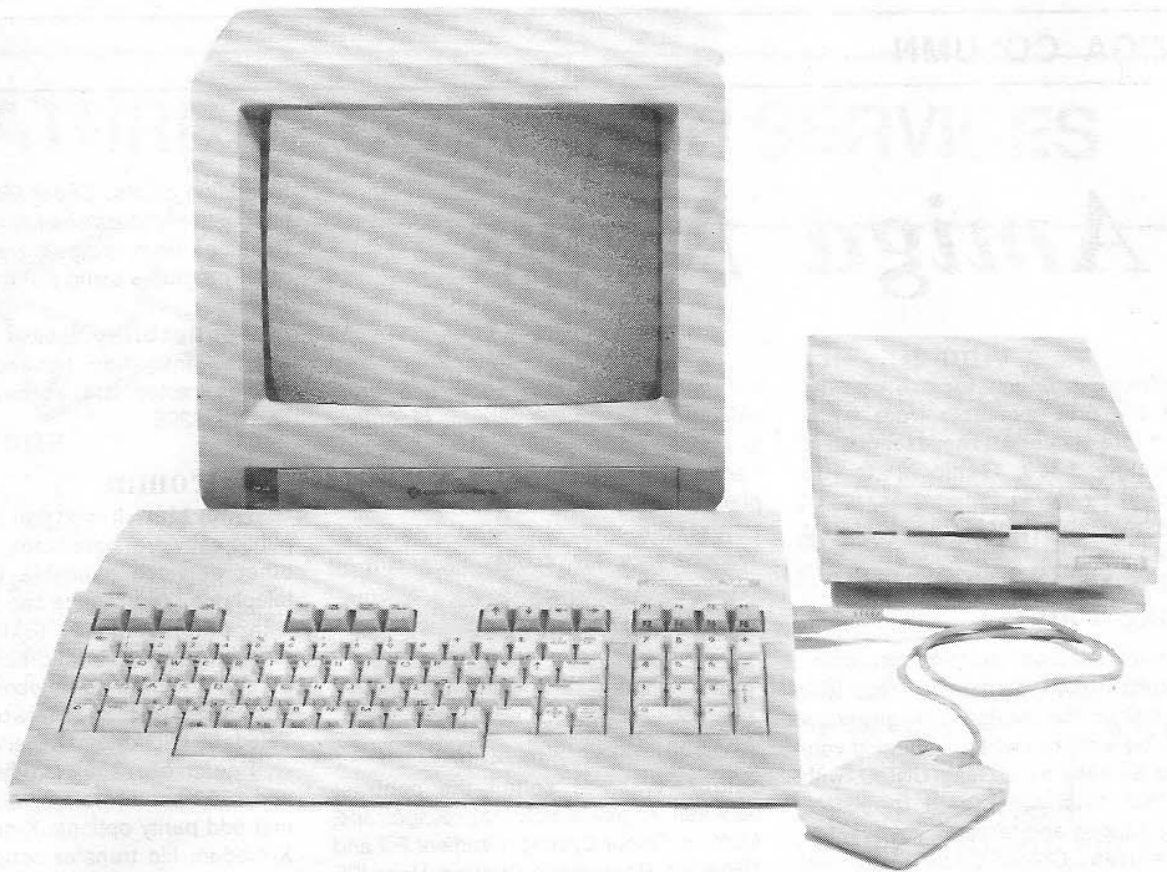

# The Commodore 128

## ...so powerful, it's 3 computers in 1



### It's a productivity computer!

The Commodore 128 will amaze you with its new generation of powerful yet easy to use productivity software. Like 'Jane', which allows you to follow simple symbols instead of typing complicated commands. And because it's so easy to learn, you'll have the 128 working hard in minutes! You get 128K of RAM both 40 and 80 column displays, and 16 colours for graphics.



### It's a family and education computer!

Switch to Commodore 64 mode and you can use more than 3,000 software packages proven on the Commodore 64, The World's No. 1 selling computer. That's power – power for studying, word processing, education; home accounts, programming, fun and games and much, much more.



### It's an advanced business computer!

The Commodore 128 lets you use software packages like 'Wordstar, dBase II and Supercalc', all in 80 columns. The Commodore 128 gives you all the computing power most businesses will ever need now or in the future.



**Power without the price. \$699.**

# Amiga News

The following products for use with the Amiga are now available from many Commodore dealers. (The exception is the Amiga 1300 Genlock, to be distributed by Neriki Enterprises, which will be available within the next two months.)

## Deluxe Paint

A sophisticated painting program. *Deluxe Paint* gives the power to draw with every colour the Amiga can generate (4096), on a screen where changing your mind is as easy as clicking UNDO, with tools that help you create the lines, curves, shapes and textures you want.

**Features:** Colour Cycle Mode that gives you animation at whatever speed you want; Unlimited Brush Set; two working screens to operate with; utilises IFF (Interchange File Format) so that pictures can be easily interchanged with other programs; full printing capabilities in either colour or black and white; complete colour control - custom mix your own on-screen colour palette of 32 colours in low resolution or 16 colours in either medium or high resolution modes.

**Applicability:** suited to professional artists, graphics designers, business graphics presentations, fabric designers, television studios, logo design and sign writers, etc.

Recommended retail price: \$245.

## Images

*Aegis Images* has been designed to meet the needs of the professional artist, or anyone who may need a powerful design tool. It's easy to learn because it uses the desktop style Amiga interface.

With *Images* 32 different colours out of a possible 4096 are usable in low resolution mode. You can mix to get the colours you want. You can draw circles, rectangles etc as well as freehand. There are 20 brushes and 16 patterns available, and they can be modified to suit you.

**Features:** *Supermove* - to rotate,

enlarge, shrink, cut, copy and drag selected areas of the screen. *Magnify* - to work on paintings at pixel level. *Grids* - can be superimposed for accurate placement of images. *Airbrush* - with adjustable nozzle and density. *Transparency* for subtle placement of

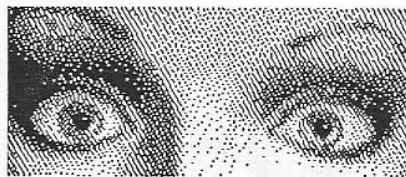

colour, *Wash* to soften the contrast between adjacent colours, *Single and Multiple Colour Cycling*, *Gradient Fill and Dithering*, *Pantograph Drawing*. Uses IFF to interchange with other programs.

**Applicability:** for technical applications in science, industry, education, marketing and communication.

Rrp: \$195.

## Animator

A metamorphic animation package for the graphics professional or hobbyist. It makes use of a concept known as "tweening" which allows movement and change within each segment of the animation.

*Animator* will allow you to create different shapes on the screen and then animate them in a variety of ways. The size, shape, colour and relative position of an object may be changed individually or at once. Allows global control of settings such as the shade of a colour.

**Features:** *Storyboard* - splits the screen into nine separate animations. *Shapes* - circles, stars, polygons can be created in filled or outline form. *Move* - you can change the position of an object relative to the current "plane" of the screen. *Rotate* - will move an object around a specified point. *Size* - used to enlarge an object proportionally. *Morph* - lets you change the shape of an object by stretching already existing points or

by adding points. *Ghost Mode* - reduces filled objects to outlines while turned on. Paintings from *Images*, *Deluxe Paint* or other programs using IFF can be used in *Animator*.

**Applicability:** suited to graphics artists, animation houses, television studios, cartoonists, education etc.

Rrp: \$295.

## Maxicomm

With *Maxicomm* you can access public software, databases, financial and other services available through your telephone. Your Amiga can communicate with other Amigas, IBMs and their compatibles, Apple Macintosh, and many others attached to telecommunication bulletin boards and networks such as Teledata, MIDAS and Minerva.

**Features:** 300, 1200, 2400, 4800 and 9600 baud rate options. None, even and odd parity options. X-on/ X-off, and X-modem file transfer options. CR, LF, TAB, translation options. Capture incoming text to disk file for printing later. Extended X-modem protocol supports workbench icon file transfers. Supports Hayes and other modems.

**Applicability:** All telecommunications applications involving programmers (file transfers), hobbyists (BBS), business (information retrieval such as finance services and airline guides) and education (database information retrieval such as STARS).

Rrp: \$195.

## Textcraft

A very easy to use word processor, so easy that the first time user can be word processing in a matter of minutes. Yet it offers most of the commonly used features that are required in home, office and educational environments.

**Features:** Operates under an easy to use icon environment, which can be used via a mouse or directly via the keyboard. Has three types of HELP structures built-in - Quick Reminder, Keyboard Reference and 1 Minute Tutorials. What you see is what is printed. Can be used in either 75 or 60 column modes for operators with impaired sight.

Commands include cut, copy, paste, reformat, left justify, right justify,

## AMIGA COLUMN

centering, left and right justification, single or double line spacing, find and replace, bold, underline, italics, subscripts and superscripts, page numbering, headers and footers, margin control. Predefined page layouts or design your own. Will print to a variety of printers.

**Applicability:** Textcraft is ideally suited to the home, the small office and the classroom.

Rrp: \$99.

### Amiga 1300 Genlock

The Amiga 1300 Genlock was designed to permit the outstanding graphics and audio created on an Amiga to be overlaid on such video sources as laser disks, video tape or other computers. And you can add these special effects to your video products in either composite or RGB format.

A home movie, training tape or video business presentation could be made more appealing by overlaying titles, captions and audio.

To link together a video camera with Amiga animations and descriptive text to produce an entertaining video, simply combine your VCR camera with an Amiga computer and 1300 Genlock and record everything on your VCR.

In addition, the 1300 Genlock gives you the ability to mix stereo Amiga computer audio with outside stereo sources for further unique results. Now you can produce your own music video.

But you'll have to wait for a while before you can get your hands on this. The 1300 Genlock will be available soon (within the next two months) from Neriki Enterprises Pty Ltd, (02) 957 4778. The price is as yet unknown.

Back Issues of The Australian Commodore Review available for \$2 each. Write to us at Top Rear, 4 Carrington Road, Randwick, NSW 2031, enclosing a cheque, or telephone Tina Spathos on (02) 398 5111 and quote your Bankcard number.

# N

NERIKI ENTERPRISES PTY. LTD.  
are proud to announce  
the arrival of...

BY COMMODORE®  
**AMIGA™**

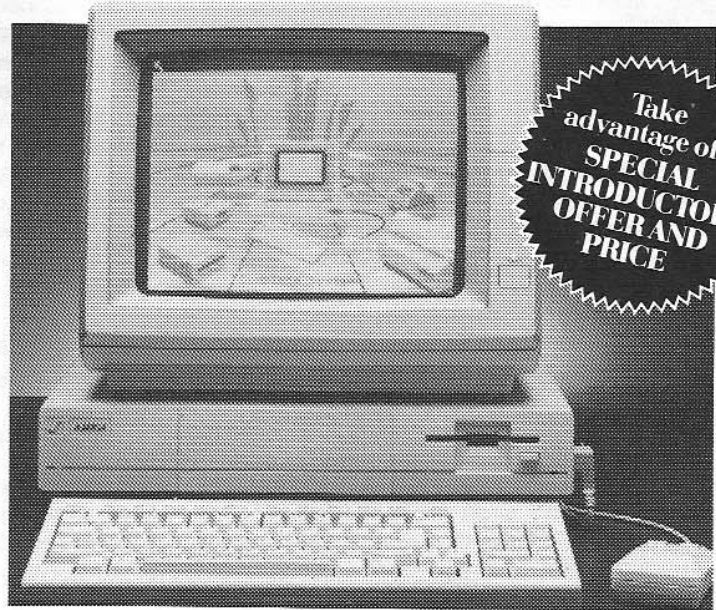

### The most powerful productivity tool in today's computer marketplace!

Designed for the professional who needs more than just a PC! AMIGA's graphics, sound and animation capabilities allow you to be totally creative, whilst improving the quality of your work.

Neriki Enterprises are leaders in the sales and development of computer systems for domestic and professional markets including:

- |  |  |
|--|--|
| <input type="checkbox"/> TELEVISION STATIONS AND PRODUCTION HOUSES | <input type="checkbox"/> EDUCATIONAL INSTITUTIONS      |
| <input type="checkbox"/> HOSPITAL AND MEDICAL PRACTITIONERS        | <input type="checkbox"/> GRAPHIC ARTISTS               |
| <input type="checkbox"/> ARCHITECTS, ENGINEERS AND BUILDERS        | <input type="checkbox"/> FASHION/INTERIOR DESIGNERS    |
| <input type="checkbox"/> ADVERTISING                               | <input type="checkbox"/> ANIMATORS                     |
|  | <input type="checkbox"/> MUSICIANS & RECORDING STUDIOS |

For a demonstration of AMIGA ring Craig Schuettrumpf on  
☎ (02) 957 4778

**NERIKI ENTERPRISES and AMIGA**

*"A Quality Team for a Quality Result"*

# Starcross

Infocom have a reputation second to none in the world of text adventures, but in *Starcross* I think they have forgotten something. Why doesn't the package (disc, booklet and starmap) contain a screwdriver?

I could get into that infernal computer and turn the (expletives deleted) thing off. Some people might think its supercilious remarks are clever, even humorous (the computer itself obviously thinks so), but when you have just struggled for half an hour to land your ship on the temptingly mysterious planetary body ("not your ordinary asteroid" says the computer, helpfully) where, I ask you, is the humour in being told "The ship is at rest, but unfortunately, so are you."

My ship was grabbed by an alien artifice and the resulting bump proved fatal. If you want a computer that runs the whole range of useful comments from surly self-satisfaction ("Maybe next time you'll listen to me") to downright sarcasm ("other than that things have been pretty dull around here"), you want to get on board the starship M.C.S. *Starcross*. Even if you don't you will find that Infocom's latest offering is another winner.

From the same stable as the ever popular *Zork*, this game is very similar in presentation, structure and feel. The instruction booklet is virtually the same as for *Zork*, being Infocom's standard guide to text adventuring, which is fair enough as the text processing, command structure and version of English is identical to that of *Zork*. This means several sentences can be in one line of input, objects can be coupled together by the use of AND, indirect objects, such as 'in the cage' are allowed (but only one per

sentence) and you can ask questions beginning 'What' or 'Where'.

Sometimes this leads to odd output, like the response "What do you want to what?" but there has been a great effort to ensure reasonable response to the majority of likely commands. There is much less of the 'guess what two word combination works in this room' syndrome than in most adventures, as in several cases different words are allowed for the same action.

All this will be familiar to previous Infocom addicts.

Sadly, the delights of sophisticated input commands just are not appreciated by all adventurers. Infocom deserve wider recognition than they presently receive.

There is one major difference between *Starcross* and *Zork*. As you may have guessed, you can talk directly to the computer which (or rather, Who) controls

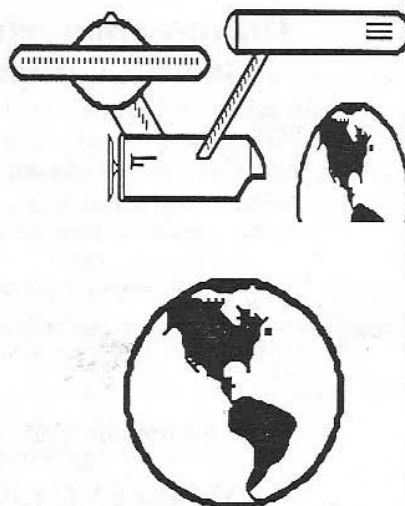

most of the happenings on your starship. Because you never invested in complete interfacing of computer to other ship's equipment (as it will readily remind you) you have to communicate with it through a natural language interface.

(In more primitive times we used to call this 'talking' - you might have heard of it.)

This is what makes *Starcross* something special. Any command can be prefaced by "Computer" in which case it is taken as a direct conversational gambit directed at the computer. The conversation is not intelligent (in other words it is purely conditioned by whether you feed it key commands) but the vocabulary is so large (I have no reason to doubt the claimed 600 words) and the allowed sentence structures so flexible (compared with the painful and familiar two word format) that many of the exchanges seem perfectly natural.

I must admit I have spent most of my time enjoying the comments of the computer rather than actually exploring the game. Probably this will become boring after a while, but not before you are well into the game and caught by its special set of problems.

The other aspect that makes *Starcross* a little different from *Zork* is the map supplied with it. It shows the position of various 'masses' around your ship at the start of the game. These objects include asteroids, planets, ships and mystery objects. Once you have discovered them you need to know how to pilot the ship (don't bother asking the computer).

The only problem is the objects themselves are moving and the map becomes invalid after move 64, so you have an additional task - navigating around the heavens working on partial information.

The map includes the headings of the objects at the start of the game, so you should be able to figure out where they are later on. In fact, you may be able to, but I'm having a little difficulty.

In effect this is a game with moving rooms which is a similitude of space - a good idea and one sufficient to renovate the tried and trusted text adventure formula. I would not say that it gives an exact representation of piloting a ship around the stars, but certainly some of



## GAMES REVIEW

the difficulties you encounter make the imaginary stellar world extremely enjoyable.

The initial scenario is perhaps a little hackneyed. I have lost count of the number of times I have awoken as the only crew member of an empty spaceship apparently knowing nothing about how to operate the ship or where things are.

And some of the 'problems' are rather trivial, like remembering to stand up or to get out of your bunk. Taken to extremes this kind of unnecessary and superfluous command could lead to adventures which require you to 'PLACE FOOT' each time you want to walk or to 'MOVE EYES' before attempting to read something.

These are legitimate, reflexive actions but perhaps could be argued to be genuine adventure commands but they only bore the player and add nothing to the feel of the game. Such unoriginality and triviality is the exception rather than the rule in *Starcross*, especially once you get into the meat of the problem - solving a riddle set aeons ago.

As is usual with Infocom the room descriptions are excellent. Who needs graphics?

Some descriptions are so long they will not fit on the screen, and all are intriguing, humorous and give plenty to think about.

Not only this but they are correctly spelt (making due allowance for colonialisms).

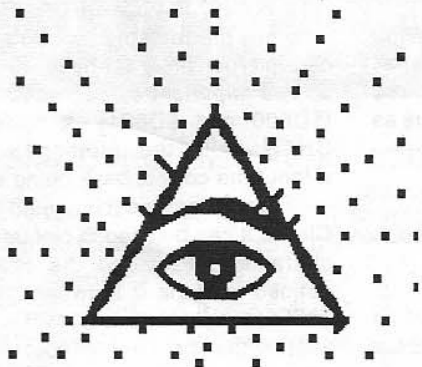

There is one slight drawback, of course, with such a large game - it is only available on disk.

It is however, almost worth investing in a disk drive to be able to play such games.

I had a little difficulty loading my copy and once, when loaded, it crashed mid-program. Other than this I could find no serious bugs in the game, though I must admit I have not solved it yet and am not likely to without many more hours play.

The need to access the disk drive slows things down a little on occasions and disk access does happen rather frequently. If your drive is prone to errors, you might want to leave this game alone as nothing could be more frustrating than a head crash midway through such a game. The delays during normal operation are no greater than many other games which involve decoding text.

All in all another winner from Infocom.

# COMPUSHACK

## WAREHOUSE SALE

The biggest and best  
sale of computer  
equipment and  
accessories.



Commodore Hardware  
Commodore Software

including: C64, 128, 128D, Amiga, PC  
and more!.....

Disk boxes, floppy disks, printers,  
paper, furniture, cables, monitors  
modems, power supplies, interfaces,  
and lots of software.

# ONE DAY ONLY!

Saturday, May 24th, 1986.

at

↙ COMPUSHACK'S  
WAREHOUSE,  
7/175 Gibbes Street, off  
Smith Street, Chatswood.

↗ Doors open at 9 AM. ↖  
Don't forget to save a stack at  
COMPUSHACK

MLC Centre  
City  
235-2455

1/303 Pacific  
Hwy  
Lindfield  
467-1933

Greenway Ade  
Church St  
Parramatta  
635-6115

# The First 100 Days

by Paul Blair

Maybe 100 days is not quite correct in mathematical terms, but with steady growth in C128 sales for just over 100 days, many of you must be enjoying your computing, so it seems like a good time to review the operation of this new computer.

If you have moved up from a C64 computer, you will be pleased with the many additional and useful commands and features of the C128. For my part, the problem is not knowing what to do, but selecting how to do it. It's like owning three cars...you can only drive one at a time.

Apart from an early run-in with electrical authorities about approvals for some of the C128 gear, we in Australia have had a good run from Commodore - at least we did get shipments of the C128 not long after the overseas release, including the 128D system box version. We weren't so lucky with the 1570 disk drive, but by now that's just an unhappy memory, except for those people who own them. There were some instances where C128's did give a few heart-stopping moments for some folk, but most of the problems have been ironed out by Commodore.

Internally, there seem to be only a few minor problems in the Basic interpreter. Maybe this is what we must come to expect with the present rate at which computer models appear and disappear. Commodore did give most of the new commands a dry (very dry, some would say) run in the Edsel Plus/4, so they were able to get a considerable amount correct with Basic 7.0. Note that I say minor problems, because there have always been a few quirks in Commodore Basic that go back to the old (anything before four years ago is old!) CBM (PET)

computers. These oddities have been repackaged free of charge with every Commodore model since.

With a greatly expanded Basic for your use, some glitches could be expected.

The thing is to know about them, and take care when writing programs to use syntax that will not stir up the troubled areas. By working your way around them they will cause the least pain. Many of you will never meet some of them, because of the type of programs that you like to write. But, forewarned is forearmed.

In these notes, I will refer to the original ROM set (Revision 0) used for all Australian deliveries to date. The three ROMs carry Commodore part numbers as follows-

BASIC LOW ROM	(\$4000-\$7FFF)	#318018-03
BASIC HIGH ROM	(\$8000-\$BFFF)	#318019-03
KERNAL ROM	(\$C000-\$FFFF)	#318020-04

There's not much point just yet in checking which ROMs are in your C128, a

hundred to one they will be Revision 0. If you doubt my word, check locations \$F7FFE, \$FBFFE and \$FCFFE with the Monitor (F8 key), and check that they are zero. If/as later revisions come along, these will be the places to check the ROM set revision number.

This is what I know, or suspect with good reason. The glitches range from very minor to watch out. In my opinion, I feel that they are not overly serious given the quite considerable task of preparing an operating system for a three-in-one computer.

**CHAR:** If you are working in 80 column mode, this command could corrupt your program because it tangles up two important screen editor registers (\$D600 and \$D601). It appears that CHAR calls the plotting subroutine without the correct bank being set first.

There is an undocumented feature of CHAR. It can be used to plot user defined characters. Provided the character is defined in Bank 0 between \$0000 and \$3FFF, the pointers at \$11EB and \$11EC will find the character for you.

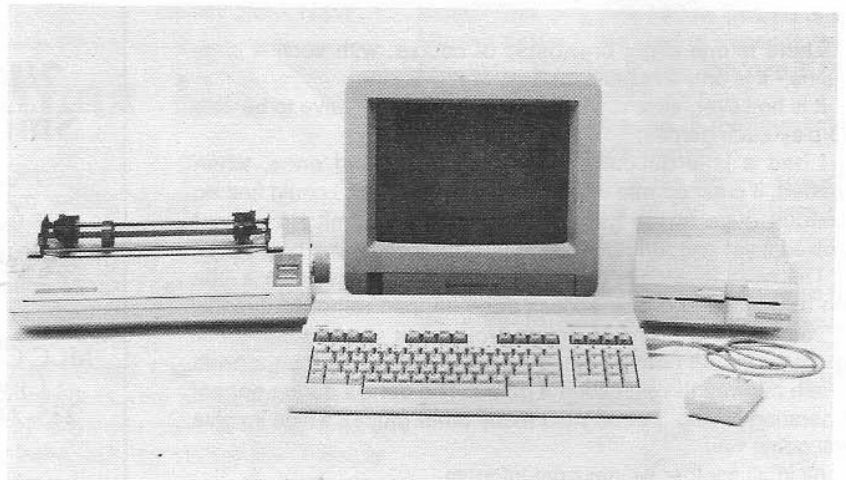

## HARDWARE REPORT

**RENUMBER:** If you renumber a program in such a way that the renumbered program requires more memory space than before (e.g., you want to use 4 and 5 digit line numbers in place of 1 and 2 digit line numbers), you could strike problems. RENUMBER must test that there is enough memory space to hold the new-style program before proceeding. The C128 gets mixed up here, and goes ahead anyway. This will only be a problem with very large programs, because of the huge program space provided in the C128.

And I notice "SYNTAX ERROR" can occur even when the command is given correctly in direct mode. Anyone else had this happen?

RENUMBER won't handle esoterics like LIST 90-150, which should read LIST 1040-1100 in the renumbered program. In fact, it does the same for anything where ranges are involved. A rare one, this.

**DELETE:** The problem here is akin to the RENUMBER glitch. If you take off the end lines of a very long program, the computer keeps going and winds up in the area of memory where the C128 sets its configuration pointers. The results are spectacular, but again you may never have a program large enough to make it happen.

**RS232 STATUS:** If you read the status variable ST after an RS232 input or output operation, you won't get the correct value. That's bad enough. But you may also corrupt an internal variable, because (as things are) the RS232 routine pops a zero into \$10A14. This may be OK, but variables are stored in Bank 1, and you may destroy or alter some value already stored there...

While on the subject of RS232, ex-C64 users beware. System initialisation of the C128 does NOT clear the RS232 registers, whereas the C64 did. YOU must clear/set them yourself. Always.

**CIRCLE:** ALWAYS specify both X and Y radii. This is because X is read and scaled, and if Y is not specified, the scaled X value is used as the default. A simple enough thing to remember.

**GRAPHICS** in general: Relative coordinates (where you move incrementally each time from the present position) may not turn out the way you

want. If you can, use absolute coordinates and there will be no hassles. This problem can crop up in LOCATE, DRAW, PAINT, CIRCLE, BOX, GSHAPE and SSHAPE. Also be careful - the present routines will NOT permit negative absolute parameters.

**PRINT USING:** Try this example, it's a good way of seeing the problem. PRINT USING "#,##\$.##";123.45. You should get \$,123.45. Or rather, you shouldn't get it! Work around this one by some testing beforehand with the sort of values you expect each PRINT USING to handle.

**DOPEN, APPEND:** The bug here is very kindly, and I fell into it very early on. You may DOPEN or APPEND two files having the same logical file number. At least, you can try to open two files. Of course, only the first file so specified will action, but you get no warning that the second file cannot DOPEN/APPEND, as a file is already open. A somewhat trivial thing maybe, but one to watch.

**CAPS LOCK/Q:** Somehow, CAPS LOCK does not think "Q" is part of the alphabet. Try for yourself. The keyboard insists that "q" is the only form of that letter that should be seen.

Now, a few system funnies. These are small points, none very serious in themselves, but you may have struck some of them and wondered why???

When saving to disk and tape, there a couple of cautions. The main one concerns the banking system now available. The usual Commodore routine saves the load address with any program/block of code. There is NO provision in the C128 to also save the bank number. So, if you save a part of memory from any bank, the load command has no way of knowing to which bank you wish to reload that block. You must help out here by presetting the bank, or including the bank number in the command line (e.g., in BLOAD).

A hung machine is a health hazard, and to be avoided. But your latest Basic program has just screeched to a halt. The keyboard is dead and you have no backup copy. Aha! Hold RUN/STOP and whack the RESET key seems a good idea. Then, when things spring to life again, type X (eXit Monitor) and all is well. Nearly, but not quite. You have just done a warm start, but there is one more step.

Before typing X, type >A04 C1 to reenable the Basic IRQ. Now, X, save a copy (please!!) and keep going. If you don't, commands like PLAY, SOUND and any sprite commands will crash again, and this time you may not be so lucky.

FNDEF is not often used (a pity, it's very useful), but it is picky. If you use a GRAPHIC command, there is some program relocation, and your FNDEFs will be lost. The fix is easy. Define GRAPHIC commands first, FNDEFs next.

There is a funny in GETKEY, I notice. Try GETKEY X, then press E or the colon, comma, full stop, plus or minus keys. GETKEY X should only accept numeric values, but it errs on the generous side.

And you all know about ESCAPE-O and ESCAPE-C? The good book says that ESC-O cancels insert and quote modes, while ESC-C cancels AUTOMATIC insert mode. Confused? So am I. It's a matter of definition, really. Insert mode actually refers to use of the INST key. Automatic insert refers to the ESC-A sequence, which pushes text along a line ahead of you, making room for the new text. So, ESC-O gets you out of difficulty if you have too many quotes or INST keys typed. ESC-C gets you out of ESC-A mode.

Some of you may use INPUT# to get user input from the screen/keyboard. This is an old trick, mainly to avoid the problem caused by pressing RETURN when there has been no user input. The interpreter can't handle a null string, and bye bye computer. The usual routine goes like this:

```
OPEN 1,0:REM OPEN FILE TO KEYBOARD
OPEN 6,3:REM OPEN FILE TO SCREEN
INPUT#1,A$:REM GET STRING
```



The C128 (and PLUS/4) has a problem with this if the string input is long, or conflicts with WINDOW settings. It is possible to fiddle around to overcome the problem, but it's not very tidy. If anyone wants, we could print it. But there are other features available to permit tidy and safe input, so this bug should not cause any great concern.

I find HELP no help at all. In previous lives on Earth, I have used all sorts of programmers' aids, most of which included something comparable to HELP in the C128. Those aids used pinpoint very clearly WHERE in a line an error lay. The C128 often reports the whole line, and then you must a'searching go. If you didn't spot your error while entering the line, you may still miss it because there is no pointer to your error.

### *Well, Mr Commodore...*

Well nothing. Commodore won't be sitting on their hands (or keyboards) and my spies tell me that Revision 1 ROMs are already appearing in new machines overseas, and it would seem that there are quite a few changes aimed at tidying up some of these items. What my spies didn't tell me was how Commodore plan to help owners of Revision 0 computers, and when we might expect to see Rev 1 in Australia. Certainly, the bugs identified so far don't concern me unduly, but the C128 is a very nice computer to use, and a de-bugged Basic would be the icing on the cake.

### *Some last points*

Because the C128 mode has a somewhat richer command set than the C64, I like to write C64 programs in C128 mode. Of course, I must stick to those commands that the C64 understands, and not use sound and graphics routines that are not present in the C64.

Having written my program, I want to test it. I find it easy to transfer programs without having to save them, reset, GO64 and reload. I simply GO64, then (in direct mode) type POKE 43,1: POKE 44,28. My program is now in my C64 mode C128, and I can happily check it out.

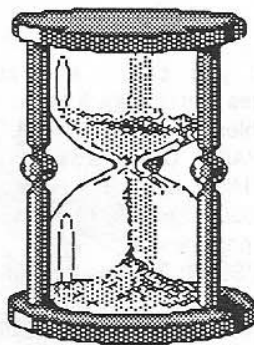

Two things for you to try. The C128 offers commands not seen in Commodore home computers before. The DO subset allows for some structure in programming, and you will find many uses for it and its associated keywords. But is it slow! Just to be flash, I took a FOR...NEXT loop out of a program recently, and replaced it with a DO...UNTIL (and I also tried DO...WHILE). The FOR...NEXT loop, when timed, was eight (8!!) times faster than the DO... syntax. This might not concern you, because there will be times when the structure of DO is more useful than sheer speed. But if you want to control a long process and be time-efficient, avoid DO loops.

If you power up in C64 mode (by holding down the C= key at the same time as cycling the mains power), the 80 column screen is not set up. If you have had enough of the C64 and decide to press down the 40/80 key and then press the reset button, the screen won't come up for you. The only way out is to fully recycle the mains power, to give the C128 screen the chance to initialize.

The FAST mode is available in C64 mode. FAST puts the processor into 2MHz gear, double the normal C64 speed. You will lose screen output as long as the processor is working FAST, but for some tasks that may not matter. To get into FAST from C64 mode, use POKE 53296,1 and to get back to SLOW use POKE 53296,0.

### *The Manuals*

The System Guide supplied with the C128 is probably Commodore's best effort to date - not that they had much to

beat. Apparently the Cretin in the Basement who usually writes documentation for Commodore has been moved to a more senior position, and now folds the cardboard shipping cartons. We in Australia escaped the worst of the problems. It has been reported in the USA that there have been a number of versions of the Guide published, with varying degrees of erroneous information. I have seen only two versions here, both reasonably accurate.

Get a pencil, and turn to Appendix K. Put a line through COLINT, MOVESHape, RLUM, RREG and RSPR. They don't exist. RREG is in the Basic 7.0 keyword table, but don't ask me what it does!

Appendix E has been whipped out of the C64 books, and reprinted without update. You need to check Appendix I (maybe move details to Appendix E to make it easier for you) for the additional CHR\$ attributes.

Don't read the CP/M section unless you want to be confused. Send in the special card and \$19.95 (that's a take!) and get the rest of the Commodore documentation. Better still - get a copy of *Inside CP/M Plus* by David Cortesi (CBS College Publishing). There is a revised BIOS disk, but its availability is not known at the time of writing.

The bottom line. Even if you are fairly familiar with Commodore Basic (say from the C64) READ the Guide carefully. The syntax for some commands has been varied slightly from what you have been used. Don't get hung up on some minor change and spend until 2am one morning searching for a bug that was only a missing comma or some such annoyance.

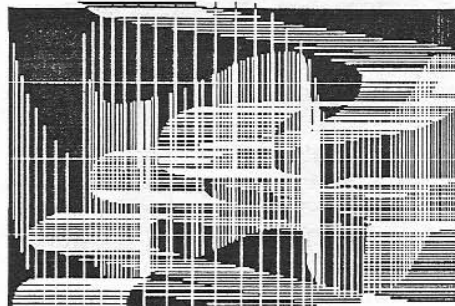

**Who needs this?**  
When you can solve disk drive alignment problems in 60 minutes with the CSM program.

**NEW PRODUCT**

**\* SNAPSHOT 64™ \***  
SNAPSHOT 64 is a new utility backup program that literally takes a "SNAPSHOT" of your computer's memory. This snapshot is then saved to disk with an autoboot so that it may be easily loaded back in. It does all this automatically and easily.  
**EASY TO USE. TAKES ONLY 3-5 MINUTES.**  
BACKS UP MANY MORE PROGRAMS THAN SIMILAR UTILITIES.  
**SOLD FOR ARCHIVAL PURPOSES ONLY.**  
EXCLUSIVE FEATURE: ALLOWS YOU TO STOP MOST PROGRAMS AT ANY POINT, LEAVING THE END THEN COMPLETE THE PROGRAM. THIS IS A VERY VALUABLE FEATURE FOR THE HACKER!!

**\$139 plus shipping**

Why be at the mercy of the repair shops, when you can own . . .

**THE 1541 DISK DRIVE ALIGNMENT PROGRAM**  
"with 1541 Disk Drive Alignment from CSM Software, you can fix it (the disk drive) in an hour or so and the program will pay for itself the first time you use it...no technical expertise is required to accomplish the alignment procedures, and the manual accompanying the program thoroughly describes the procedures."  
"1541 Disk Drive Alignment...a wise addition to your home disk library."  
From COMPUTE!'s Gazette, Oct 1984  
**1541 DISK DRIVE ALIGNMENT PROGRAM VERSION 2.0**

**\$85 plus shipping**

**OTHER QUALITY PRODUCTS**

- PROGRAM PROTECTION MANUAL FOR THE C64 VOLUME II**  
\$49 plus shipping
- CSM PROGRAM PROTECTION MANUAL FOR THE C64 VOLUME I**  
\$49 plus shipping
- Epro Programmer Manual**  
\$49 plus shipping
- CARTRIDGE BACKER**  
\$99 plus shipping
- PROGRAM PROTECTION KIT I**  
ALL 3 MANUALS  
ONLY \$135 plus shipping
- \*SKAI MULTI KERNAL**  
IN STOCK NOW!

**Fast delivery!**

**MAIL ORDERS:**  
Send Cheque/Postal Order or Bankcard/Visa details.  
**PHONE ORDERS;**  
Phone our Toll-Free order line and give us your credit card details. We send out same day.  
**BENSON COMPUTERS**

**Benson Computers Pty Ltd**

Shop hours 9-6 Mon-Fri; 9-2 Sat  
177 Barkly St, St Kilda Sth, Vic 3182  
**ENQUIRIES (03) 534 0994**  
Toll-Free orders only 008 334854



**BENSON COMPUTERS**

**ULTRABYTE DISK NIBBLER VERSION 2.2**

**Best Copier**

Now the Nibbler has been improved to copy virtually anything that can be written by a 1541 or Skai, all in less than three minutes.

**FOR SKAI, 1541 & DUAL MSD DRIVE**

- \* Simple. Even a beginner makes perfect copies
- \* Fast. Copies protected disks in three minutes
- \* Sophisticated. Senses the disk being copied and automatically adjusts for dozens of protection schemes. Copies 99+% of software
- \* Modular design to allow easy updates
- \* Even copies itself. For this reason, no refunds will be given

**\$99.95 plus shipping and handling**

**SKAI-64 SUPERDRIVE MK III**

A totally new level of speed, performance, and compatibility. It comes complete with manual, cable and Turbocharged Utilities Disk with over 20 programs included free!

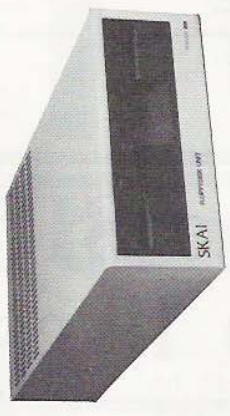

Formats a 35 track disk in 25 secs or a 40 track disk in 30 secs, giving up to 21K of extra storage. Never overheats and will never need realigning. Top Quality, State of the Art, Japanese Technology



**ONLY \$349 plus shipping**

# The SID Chip lives on

Commodore's model 6581 Sound Interface Device (SID), is an exciting piece of hardware. It's truly impressive: an entire music synthesizer on a single chip. SID is standard equipment in Commodore's newest computer with 64K of RAM. In this article I will describe SID's features, and give you some ideas on how it can be used.

## Overview

Figure 1 shows a block diagram of the chip. As you can see it has three voices, meaning it can produce three notes at once. Each voice consists of a tone generator, which produces the sound, and an envelope generator, which controls the volume. There are also some modulation effects, in which two tone generators combine to produce one complex sound.

The signals from the voices may be routed through a filter, which acts like a super tone control. This is the thing that makes SID so powerful, and so much more versatile than the sound generators on other home computers.

Other features of SID include a master volume control, and an external audio input that allows you to run a signal from your electric guitar or other source through SID's filter. There are also two A/D converters on the chip, intended for connecting to pots. These are not electrically connected to anything else in SID, so you can use them for game controllers or whatever.

SID's functions are controlled by a number of 8-bit registers. In Commodore's machines, the chip is mapped into

the memory address space, so you can write data into the registers with POKE statements. Each voice has seven registers for controlling its specific functions, and there are 8 more registers for controlling the filter, master volume, etc. Figure 2 illustrates the control registers.

Figure 2 SID control registers.

Address	DATA								REG NAME
	D7	D6	D5	D4	D3	D2	D1	D0	
54272	F <sub>1</sub>	F <sub>1</sub>	F <sub>1</sub>	F <sub>1</sub>	F <sub>1</sub>	F <sub>1</sub>	F <sub>1</sub>	F <sub>1</sub>	VOICE 1
54273	F <sub>1</sub>	F <sub>1</sub>	F <sub>1</sub>	F <sub>1</sub>	F <sub>1</sub>	F <sub>1</sub>	F <sub>1</sub>	F <sub>1</sub>	FREQ LO
54274	PW <sub>1</sub>	PW <sub>1</sub>	PW <sub>1</sub>	PW <sub>1</sub>	PW <sub>1</sub>	PW <sub>1</sub>	PW <sub>1</sub>	PW <sub>1</sub>	FREQ HI
54275	—	—	—	—	PW <sub>1</sub>	PX <sub>1</sub>	PW <sub>1</sub>	PW <sub>1</sub>	PW LO
54276	NOISE	—	—	—	TEST	RING	MOD	SYNC	PW HI
54277	ATK <sub>1</sub>	ATK <sub>1</sub>	ATK <sub>1</sub>	ATK <sub>1</sub>	DCY <sub>1</sub>	DCY <sub>1</sub>	DCY <sub>1</sub>	DCY <sub>1</sub>	CONTROL REG
54278	STN <sub>1</sub>	STN <sub>1</sub>	STN <sub>1</sub>	STN <sub>1</sub>	RLS <sub>1</sub>	RLS <sub>1</sub>	RLS <sub>1</sub>	RLS <sub>1</sub>	ATTACK / DECAY
54279	F <sub>2</sub>	F <sub>2</sub>	F <sub>2</sub>	F <sub>2</sub>	F <sub>2</sub>	F <sub>2</sub>	F <sub>2</sub>	F <sub>2</sub>	SUSTAIN / RELEASE
54280	F <sub>2</sub>	F <sub>2</sub>	F <sub>2</sub>	F <sub>2</sub>	F <sub>2</sub>	F <sub>2</sub>	F <sub>2</sub>	F <sub>2</sub>	VOICE 2
54281	F <sub>2</sub>	F <sub>2</sub>	F <sub>2</sub>	F <sub>2</sub>	F <sub>2</sub>	F <sub>2</sub>	F <sub>2</sub>	F <sub>2</sub>	FREQ LO
54282	PW <sub>2</sub>	PW <sub>2</sub>	PW <sub>2</sub>	PW <sub>2</sub>	PW <sub>2</sub>	PW <sub>2</sub>	PW <sub>2</sub>	PW <sub>2</sub>	FREQ HI
54283	—	—	—	—	PW <sub>2</sub>	PX <sub>2</sub>	PW <sub>2</sub>	PW <sub>2</sub>	PW LO
54284	NOISE	—	—	—	TEST	RING	MOD	SYNC	PW HI
54285	ATK <sub>2</sub>	ATK <sub>2</sub>	ATK <sub>2</sub>	ATK <sub>2</sub>	DCY <sub>2</sub>	DCY <sub>2</sub>	DCY <sub>2</sub>	DCY <sub>2</sub>	CONTROL REG
54286	STN <sub>2</sub>	STN <sub>2</sub>	STN <sub>2</sub>	STN <sub>2</sub>	RLS <sub>2</sub>	RLS <sub>2</sub>	RLS <sub>2</sub>	RLS <sub>2</sub>	ATTACK / DECAY
54287	F <sub>3</sub>	F <sub>3</sub>	F <sub>3</sub>	F <sub>3</sub>	F <sub>3</sub>	F <sub>3</sub>	F <sub>3</sub>	F <sub>3</sub>	SUSTAIN / RELEASE
54288	F <sub>3</sub>	F <sub>3</sub>	F <sub>3</sub>	F <sub>3</sub>	F <sub>3</sub>	F <sub>3</sub>	F <sub>3</sub>	F <sub>3</sub>	VOICE 3
54289	F <sub>3</sub>	F <sub>3</sub>	F <sub>3</sub>	F <sub>3</sub>	F <sub>3</sub>	F <sub>3</sub>	F <sub>3</sub>	F <sub>3</sub>	FREQ LO
54290	PW <sub>3</sub>	PW <sub>3</sub>	PW <sub>3</sub>	PW <sub>3</sub>	PW <sub>3</sub>	PW <sub>3</sub>	PW <sub>3</sub>	PW <sub>3</sub>	FREQ HI
54291	—	—	—	—	PW <sub>3</sub>	PX <sub>3</sub>	PW <sub>3</sub>	PW <sub>3</sub>	PW LO
54292	NOISE	—	—	—	TEST	RING	MOD	SYNC	PW HI
54293	ATK <sub>3</sub>	ATK <sub>3</sub>	ATK <sub>3</sub>	ATK <sub>3</sub>	DCY <sub>3</sub>	DCY <sub>3</sub>	DCY <sub>3</sub>	DCY <sub>3</sub>	CONTROL REG
54294	STN <sub>3</sub>	STN <sub>3</sub>	STN <sub>3</sub>	STN <sub>3</sub>	RLS <sub>3</sub>	RLS <sub>3</sub>	RLS <sub>3</sub>	RLS <sub>3</sub>	ATTACK / DECAY
54295	—	—	—	—	FC <sub>1</sub>	FC <sub>1</sub>	FC <sub>1</sub>	FC <sub>1</sub>	SUSTAIN / RELEASE
54296	FC <sub>2</sub>	FC <sub>2</sub>	FC <sub>2</sub>	FC <sub>2</sub>	FC <sub>2</sub>	FC <sub>2</sub>	FC <sub>2</sub>	FC <sub>2</sub>	FILTER
54297	RES <sub>1</sub>	RES <sub>1</sub>	RES <sub>1</sub>	RES <sub>1</sub>	FILT	FILT	FILT	FILT	FC LO
54298	3 OFF	HP	BP	LP	VOL	VOL	VOL	VOL	FC HI
54299	PX <sub>1</sub>	PX <sub>1</sub>	PX <sub>1</sub>	PX <sub>1</sub>	PX <sub>1</sub>	PX <sub>1</sub>	PX <sub>1</sub>	PX <sub>1</sub>	RES / FILT
54300	PY <sub>1</sub>	PY <sub>1</sub>	PY <sub>1</sub>	PY <sub>1</sub>	PY <sub>1</sub>	PY <sub>1</sub>	PY <sub>1</sub>	PY <sub>1</sub>	MODE / VOL
	O <sub>1</sub>	O <sub>1</sub>	O <sub>1</sub>	O <sub>1</sub>	O <sub>1</sub>	O <sub>1</sub>	O <sub>1</sub>	O <sub>1</sub>	MISC
	E <sub>1</sub>	E <sub>1</sub>	E <sub>1</sub>	E <sub>1</sub>	E <sub>1</sub>	E <sub>1</sub>	E <sub>1</sub>	E <sub>1</sub>	POTX
									POTY
									OSCS / RANDOM
									ENV3

Figure 1 Block diagram of the Commodore 6581 Sound Interface Device (SID).

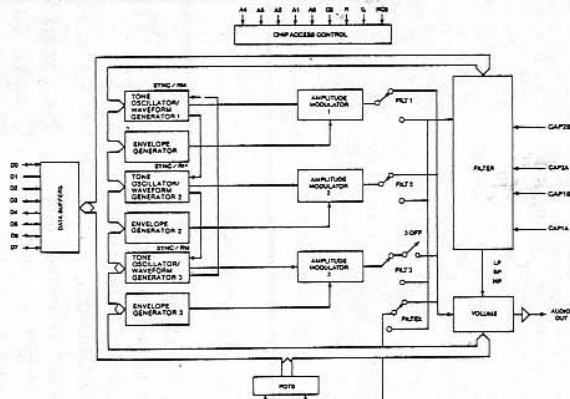

## Tone Generators

SID has three tone generators, each of which can generate four different waveforms: sawtooth, triangle, pulse, and noise. Sawtooth waves contain lots of harmonics, and are good for rich sounds like horns or strings. Triangle waves only have a little bit of harmonic energy, so they have a very mellow, flute-like sound.

Pulse waves can have a lot of different sounds, depending on the pulse width, which you can vary. When the pulse width is at or near 50%, you set a square wave, which is sort of hollow or clarinet-like. When the pulse width is close to zero (or to 100%; they both sound the same to the ear), the tone is very thin, more like an oboe. In between is an impressive variety of sounds, including saxophones, and sometimes human voices, if you set the filter right.

The noise waveform has no precise pitch; it's used for untuned sounds like percussion, wind, or jet engines. With this waveform, low notes come out as a deep rumble, and high notes sound like a snake's hiss.

The frequency of each tone generator is set by a 16-bit number that you POKE into two control registers (high and low bytes). The output frequency in Hertz is equal to the number in the registers multiplied by 0.0596. Table 1 gives the numbers that you use for the notes of the musical scale. SID has a

range of eight octaves; is that enough for you? It ought to be; it's more than almost any conventional instrument can play.

With a 16-bit frequency control, there are a lot of pitches in between the notes of the scale. You can generate glissando or portamento effects by rapidly incrementing or decrementing the number in these registers, so that the sound makes a smooth sweep from one pitch to another. You can also set two or three tone generators to be just a tiny bit out of tune with each other, which gives a rich, chorus-like quality to the sound.

Actually, SID's range is more than eight octaves: it can be turned so low that you can't hear it, down to about 1 cycle every 16 seconds! We'll look at uses for the sub-audio range a little later.

Each voice has a control register that contains one bit for each of the four waveforms. If you turn on more than one of these bits, the resulting sound will be a logical ANDing of the selected waveforms. This could give you some interesting effects, but usually you will only use one waveform at a time. A word of warning: combining the noise waveform with any others may "lock it up", cancelling the noise output until you reset it with the Test bit or the chip Reset line.

When you select the pulse wave, the pulse width is set by a 12-bit number, which occupies two control registers. You can smoothly sweep the pulse width from one value to another, which gives a very nice soaring or "phase shifting" sound.

The control register contains bits for ring modulation and synchronization functions. These two effects are similar: they both take input from two tone generators, and produce an output that has some components of the inputs, plus some other frequencies that aren't present in either input. This can produce metallic sounds such as chimes and gongs. If you vary the frequency of one of the inputs while listening to the signal, you get a great science fiction-type sound in which you can hear some pitches rising, while others are falling at the same time. Note that the ring-mod function only affects the triangle wave output, but the synch function applies to all waveforms.

The difference between the two effects is something that I can't really describe in words, so I suggest you just try it. For some really wild sounds, you can use both effects at once. For example, you can set voice 2 to be in synch with voice 1, and set voice 3 to be ring-modulated by voice 2. I once did something like that with an ARP 2600 synthesizer, and got a really nice simulation of someone banging on a garbage can.

Each voice has a Test bit that, when set to 1, turns off all waveforms and resets the internal counters to zero. Commodore's spec sheets suggest that this feature may have some musical applications, but do not give any specific uses. I do have a couple of ideas, though: if you want to create a complex sound by combining two or three voices, you can use the Test bit to make sure that all the tone generators start their waveforms at the same moment; otherwise the slight delay might produce random variation in the sound. Also, the Test bit can be used to turn a voice on and off instantly, whereas using the envelope generator takes at least a few milliseconds.

## Envelope Generators

This is another important synthesizer function. The term "envelope" refers to the way in which the volume changes during the playing of a note. Each note is divided into four phases called attack, decay, sustain, and release. In the attack phase, the volume rises from zero to a maximum or peak value. Then, during the decay, the volume falls off to some intermediate level. Next comes the sustain, in which the volume remains constant for as long as you want to hold the note. Finally, during the release, the volume falls back to zero.

The attack, decay, and release times, as well as the difference between the peak and sustain volume, are important factors in making one instrument sound different from another. For instance, as Figure 3 shows, a trumpet has a very short attack and decay time, giving a quick snap of loud sound at the beginning of each note. Then the volume remains constant as long as the musician keeps

blowing, and when he or she stops, the note takes a tenth of a second or so to die out (release). Compare this to the violin envelope, which has a slow attack and no pronounced peak. The xylophone, by contrast, has a very fast attack, but no sustain at all; the note always dies away quickly.

Figure 3 Sound envelopes of some typical instruments.

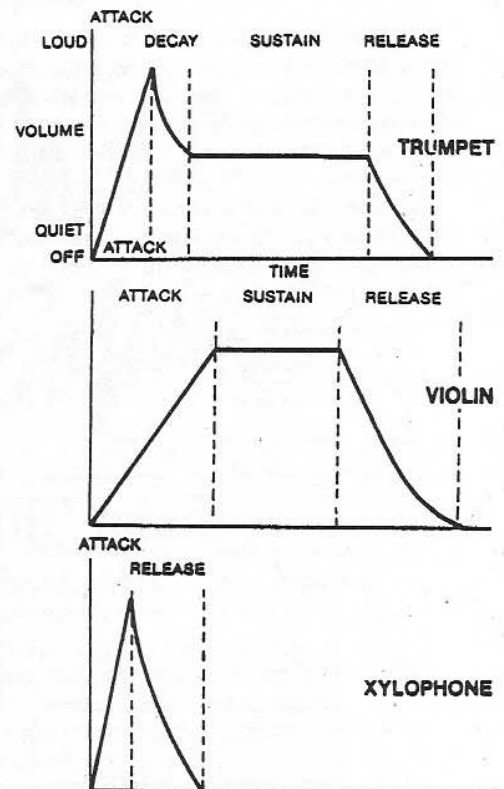

Each voice in SID has its own controls for attack, decay, sustain and release. Each of these parameters is controlled by a four-bit number that can select one of sixteen possible values. The attack and decay are set by one control register, and the sustain and release by another. The attack times range from 2 msec. to 24 seconds. The sustain is not a time; it's a volume. If it is set to maximum (15), the volume will remain at the peak level, like the violin envelope in Figure 3.

The envelope generator is activated by a bit in the voice's control register called the Gate. (This is a synthesizer term, not really related to the logic gates we computer hackers are used to). Setting the Gate to 1 starts a note; it causes the envelope generator to do its

attack-decay-sustain phases. When the Gate is set to 0, the note begins its release phase. Note that the attack has a linear slope, but the decay and release have an exponential curve. This is a nice touch; it corresponds to the way that strings, horns, and other vibrating objects generally behave. Most synthesizers do either linear or exponential slopes, but not both.

## Filter Section

The filter, in a sense, is the heart of a synthesizer. Granted, it doesn't actually produce sound, it just modifies what the tone generators produce. However, you will find that the filter has more control than anything else over what you hear. I'd rather have one waveform and a filter than a whole lot of waveforms and no filter.

The filter's function is similar to the tone controls on a hi-fi, in that it allows you to emphasize or remove certain parts of the audio spectrum. The range of possible effects is shown graphically in Figure 4.

Figure 4 Some effects that SID's filter can produce.

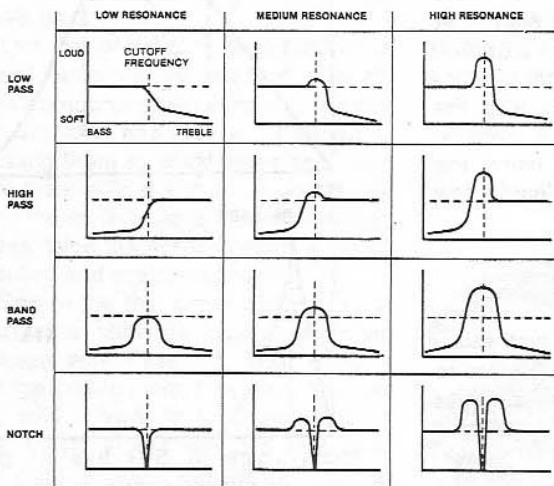

SID's filter has three outputs. The low-pass output, as its name implies, will pass all signals below a certain frequency, called the cutoff frequency. Everything above the cutoff is "rolled off" (reduced in volume) at a rate of 12 dB per octave; the higher the frequency, the more it is reduced. Similarly, the high-pass output passes signals above the cutoff, and rolls off everything below it. The band-pass output rolls off frequencies above or below, and passes only those signals that are fairly close to the cutoff frequency.

Each of the filter's outputs is controlled by a single bit in one of SID's registers, so by setting several bits to 1, you can mix the outputs. Mixing the high-pass and low-pass outputs gives what is called a notch filter. This is the opposite of the band-pass: it rejects frequencies near the cutoff, and passes everything else.

The cutoff frequency is selected by an 11-bit number that you poke into two control registers. With the recommended

2200pf capacitors, the cutoff frequency can range from 3-Hz to 10kHz.

The filter also has a resonance of "Q" control. This determines how strong the effect is. With low resonance, the sound is not too different from your hi-fi's tone controls. With high resonance, you get a very intense effect, like different vowel sounds of the human voice. A rock guitarist's wah-wah pedal is just a band-pass filter with a very high resonance. It goes "wah" when the musician raises the cutoff frequency by pushing down on the pedal, and it goes "yow" when he or she lowers the cut-off by moving the pedal the other way. You can produce the same effect with SID by selecting a high resonance, and varying the cutoff while a note is playing.

Most synthesizers provide an envelope generator that controls the filter cutoff, allowing it to automatically rise and fall every time a note is played. SID does not provide this feature, but you can write a program to do it. Some of the more expensive synthesizers can also change the resonance in the same manner. The effect is more subtle, but useful to the advanced synthesist. With SID, once again, you can do this under program control; isn't software wonderful?

Note	Note-Octave	Hi Freq	Low Freq	Note	Note-Octave	Hi Freq	Low Freq
0	C-0	1	18	48	C-4	17	37
1	C#-0	1	35	49	C#-4	18	42
2	D-0	1	52	50	D-4	19	63
3	D#-0	1	70	51	D#-4	20	100
4	E-0	1	90	52	E-4	21	154
5	F-0	1	110	53	F-4	22	227
6	F#-0	1	132	54	F#-4	24	63
7	G-0	1	155	55	G-4	25	177
8	G#-0	1	179	56	G#-4	27	56
9	A-0	1	205	57	A-4	28	214
10	A#-0	1	233	58	A#-4	30	141
11	B-0	2	6	59	B-4	32	94
12	C-1	2	37	60	C-5	34	75
13	C#-1	2	69	61	C#-5	36	85
14	D-1	2	104	62	D-5	38	126
15	D#-1	2	140	63	D#-5	40	200
16	E-1	2	179	64	E-5	43	52
17	F-1	2	220	65	F-5	45	198
18	F#-1	3	8	66	F#-5	48	127
19	G-1	3	54	67	G-5	51	97
20	G#-1	3	103	68	G#-5	54	111
21	A-1	3	155	69	A-5	57	172
22	A#-1	3	210	70	A#-5	61	126
23	B-1	4	12	71	B-5	64	188
24	C-2	4	73	72	C-6	68	149
25	C#-2	4	139	73	C#-6	72	169
26	D-2	4	208	74	D-6	76	252
27	D#-2	5	25	75	D#-6	81	161
28	E-2	5	16	76	E-6	86	105
30	F-2	6	16	77	F-6	91	140
31	G-2	6	108	78	F#-6	96	254
32	G#-2	6	206	79	G-6	102	194
33	A-2	7	53	80	G#-6	108	223
34	A#-2	7	163	81	A-6	115	88
35	B-2	8	23	82	A#-6	122	52
36	C-3	8	147	83	B-6	129	120
37	C#-3	9	21	84	C-7	137	43
38	D-3	9	159	85	C#-7	145	83
39	D#-3	10	60	86	D-7	153	247
40	E-3	10	205	87	D#-7	163	31
41	F-3	11	114	88	E-7	172	210
42	F#-3	12	32	89	F-7	183	25
43	G-3	12	216	90	F#-7	193	252
44	G#-3	13	156	91	G-7	205	133
45	A-3	14	107	92	G#-7	217	189
46	A#-3	15	70	93	A-7	230	176
47	B-3	16	47	94	A#-7	244	103



# SPECIAL INTRODUCTORY OFFER FOR COMMODORE 64/128 OWNERS

CHOOSE 1 TO 3 ITEMS FROM AS LITTLE AS \$6 EACH

**SEND IN THE COUPON NOW AND JOIN  
\*\*\* A GREAT CLUB \*\*\***

PLUS POSTAGE & PACKING \*

There couldn't be a better time to join. This is a special introductory offer to join The Australian Home Computer Club. A club that will cater for every piece of 64 software or book you ever wanted or will ever need, and all at a saving of up to 25% off recommended prices. Just fill in the coupon provided, then from all the items listed, choose any three (3) you want, it's up to you! The prices start from \$6.00 (+ post and packing \*). If you decide to take the three (3) highest value items, you could save over 42% on recommended and publishers prices.

### HERE'S WHAT YOU DO.

Choose your items from the list, add them together with the post and packing \* and fill in the application to join coupon telling us how you wish to pay for them and where to send them to.

Then mail to:—

**THE AUSTRALIAN HOME COMPUTER CLUB. BOX 48, CHARLESTOWN, 2290 N.S.W.** You will then receive the items you have chosen at the **SPECIAL INTRODUCTORY PRICE** (plus post & packing \*) followed shortly after by your first **FREE CLUB NEWSLETTER**. This will be posted to you every two (2) months and will contain clear and helpful descriptions of all the books and software offered. These items will be specially chosen from the finest books and software available today from both Australia and overseas and will be at a saving of up to 25% off recommended and publishers prices. Your only commitment is to take at least one (1) item every two (2) months for the first year of your membership.

**ALL ITEMS ORDERED FROM THE CLUB NEWSLETTER WILL BE SENT ON INVOICE.**

If you don't wish to damage this magazine by cutting out the coupon, a photocopy will do. **DON'T DELAY — JOIN TODAY.**



- |   |         |              |
|---|---------|--------------|
| 1. Revs (Firebird) .....                    | \$28.95 | Save \$11.00 |
| 2. Fourth Protocol (Hutchinson) .....       | \$29.95 | Save \$10.00 |
| 3. Machine Lightning (Oasis) .....          | \$59.95 | Save \$20.00 |
| 4. 747 Simulator (Doc Soft) .....           | \$27.95 | Save \$ 7.00 |
| 5. Thunderbirds (Firebird) .....            | \$10.95 | Save \$ 4.00 |
| 6. Phantom of the Asteroid (M-Tronic) ..... | \$ 6.00 | Save \$ 2.00 |
| 7. Skool Days (Microsphere) .....           | \$18.95 | Save \$ 6.00 |
| 8. C64 Head Align Kit (Interceptor) .....   | \$22.95 | Save \$ 7.00 |
| 9. BMX Races (Mastertronic) .....           | \$ 6.00 | Save \$ 2.00 |
| 10. U.K. Trivia (Anirog) .....              | \$19.95 | Save \$15.00 |

### APPLICATION TO JOIN:

**THE AUSTRALIAN HOME COMPUTER CLUB. Pty.Limited.**  
P.O. BOX 48, CHARLESTOWN, 2290 N.S.W.  
PHONE (049) 43 6398

Please accept my application and enrol me as a member of The Australian Home Computer Club. Send me the introductory items the numbers I have indicated in the boxes below.

The club's FREE newsletter 'asSYStance', describing the featured selection of the month and alternative choices will be sent to me about every two months. If I wish to purchase the featured selection, I need do nothing and it will be sent to me automatically. If I prefer any of the alternative choices in addition to, or instead of, the featured selection I will advise the Club by returning the order form provided by the date it specifies. I understand that as a member of the Club I need to purchase only 6 more items during the next 12 months in addition to my introductory items and I may resign my membership anytime thereafter. If I am under 18 years of age membership must be in the name of a parent or guardian and their signature is required. The software offered to me will be up to 25% off recommended prices.

OFFER APPLIES IN AUSTRALIA ONLY.  
LIMITED TO ONE PER HOUSEHOLD.

MR/MRS/MISS ..... DATE .....

BLOCK LETTERS

ADDRESS .....

POSTCODE .....

I am over the age of 18. SIGNATURE .....

Total of software and/or books chosen \$ .....

Add postage and packing \$ 3.50 \*

Total payable \$ .....

Payment of introductory software and/or books is to be made by (Place ✓ in appropriate box)

CHEQUE ENCLOSED  M.O. ENCLOSED

BANKCARD  VISA

MASTERCARD  Do you own a disk drive

CARD NUMBER ..... EXPIRY DATE .....

PHONE NUMBER ..... DATE .....

Please charge to my card. SIGNATURE .....

## HARDWARE

Each of the three voices can be routed through the filter, or it can be sent directly to the main output. This feature helps make up for the fact that there are three voices but only one filter. You can filter one voice, and use pulse width changes to produce filter-type effects on the other two.

### Other features

As I mentioned earlier, SID has an external input that can be used with any instrument, recording, or even a microphone. This input can be sent through the filter, or it can go directly to the output. With a microphone or instrument, you may need to amplify the signal before running it into SID. The maximum input is 3 volts peak-to-peak.

SID has a master volume control that ranges from zero to 15. This controls all the voices, the filter, and the external input. You can produce tremolo effects by rapidly raising and lowering the volume.

Voice 3 has a couple of special features that are quite handy. There is a register that you can read to get the instantaneous value of the tone generator's output, and another that lets you read the envelope generator's output. What are these good for? Well, earlier I mentioned that it would

be nice to have another envelope generator to control the filter. You can use voice 3's envelope generator to do this, by putting some statements in your program to read the envelope value, and POKE it into the filter cutoff.

You can use the waveform value register in a similar manner. For instance, set up voice 3 to produce a triangle wave at a very low frequency, say 3 or 4 Hz. Then write a program that continuously reads the waveform value, and adds it to the frequency numbers for voice 1 and/or 2. The result is vibrato: continuous up-down variation of the pitch.

Of course, when you're using voice 3 in this manner, you probably won't want to listen to it at the same time. Fortunately, there is a control bit that disables voice 3's output, so that it won't produce unwanted sounds.

One other use for voice 3: if you set it to the noise waveform at some very high frequency, the waveform value at any instant is essentially random. Thus you have an instant random number generator.

SID contains two A/D converters that are intended for connection to pots, for use as game paddles or other control functions. You might want to go to a music store, and buy an old used wah-wah pedal. Tear out all the electronics, put in a 470K pot, and run it to one of the A/D inputs. Presto, you've got a wah-wah pedal for your computer ... or a volume pedal, or a tremolo pedal, etc. Like I said, isn't software wonderful?

The A/D inputs are scanned about once every half a millisecond, so it's possible that they could be used to listen to an external sound and compute its pitch. Then SID could play or sing along with you.

### Technical details

Originally I was going to title this section "Bugs" or "Criticisms", but really, this chip is so wonderful that I couldn't bring myself to use such derogatory language. However, there are one or two things that I just couldn't resist pointing out.

Most of the control registers are "write-only", meaning that you can POKE things into them, but you can't PEEK at them to find out what their current settings are. So you may need to store their values in a table, and have your program update the table whenever it changes one of the registers.

If you've used some other synthesizers, you may notice that SID's filter effects are not quite as intense as you expected. This is because SID's filter has a 12 dB per octave roll-off, whereas most synthesizers have 24 dB per octave. However, you can always set two SIDs, and run one into the other through the external input. It'll still cost a heck of a lot less than a new Korg or MiniMoog.

Although SID has a master volume control, it does not have controls that let you set one voice louder or quieter than the others. This could be a problem if you're trying to play a fairly complex piece of music with a lot of variety between the voices. In a pinch, you could write a program to rapidly switch a voice's Gate signal on and off, so that the volume hovered around some intermediate level.

In summary, my hat is off to Commodore for producing a chip that turns a home computer into a real synthesizer. Does anyone out there want to buy a used Korg?

# AVTEK

**Australia's top selling modem  
costs only \$199**

When you need fast, reliable communication for your Commodore computer, Avtek is the right choice. With a range of modems from \$199.00 (inc tax) you get the best, plus all the features the others can't offer.

- 1 All data standards available (V21, V22, V23).
- 2 Digital filtering for the ultimate in reliability, even on very noisy lines.
- 3 Fully Viatel compatible

### Avtek (Electronics)

PO Box 651, Lane Cove 2066  
Phone (02) 427 6688



# MUSIC

## Why you need a computer aided music system

by Ric Richardson

People are always telling you that you need to spend money. You want to go faster, you've got to spend money. You want to see something new, you've got to spend money. It seems whenever you want to have some fun, you are reaching into your back pocket. Of main concern is finding a way to have more fun without the pain of big bills.

Music on its most basic level is quite an inexpensive pastime. An acoustic guitar can get you singing your favourite songs for under \$100. (That's if you have enough ability to get by without lessons for twelve dollars a hit.) If you are a proficiendo of the piano, a cheap keyboard can be had for a couple of hundred dollars, a la Casio, and you have entered the world of music for the masses.

This is all very well. But if your aspirations require sounds that are good enough to put on vinyl, you have got to expect to spend many multiples of this.



As you continue in your endeavours, you will find music by yourself a bit boring. After the acquisition of bodybuilding guitar amps or keyboards, depending on which camp you belong to, the next step is to find a band!

After a few years of dragging gear from friend's place to friend's place, you have found the idea of making music in the comfort of your home studio (sunroom) that bit more palatable. You have, at much pain, worked out what each instrument in a band does, and you set about the job of getting all those ideas captured on tape. If you are like me, a plan is set to save for all the required instruments. A drum kit, bass guitar, keyboard and singing lessons, not to mention the trusty Strat (standard guitar for rock 'n roll, the Fender Stratocaster). Oh, and not forgetting the need for special multi track recording gear that enables you to layer each instrument on top of each other, bringing your musings to life.

Total cost? If everyone saw this figure before they set out to write and play music, I think there would be a lot fewer musicians. A decent recordable guitar, \$300. A half decent bass guitar, \$300. The most basic synthesizer, \$700. And then there are the drums, and they are a real headache.

By now you will have no doubt been informed of the most convenient, best sounding way of getting your rhythm down. Music technology's wonderful gift, the drum machine. Cost, anywhere between \$600 and \$2,500. To get this on tape, another \$1,000 gets you the basics in multi track recording gear.

Add this up and you find it quite staggering that so many out there are so addicted to music. But many of you, like

me, are slaves to our love, desperately making do, finding even this system of music-making to be a cumbersome yet necessary evil.

Like some distant relative of a used car salesman, of late, I have been desperately trying to con as many as possible with the idea of getting a computer to take the hassles out of our dearly loved endeavour. Yes, computers armed with this mystic acronym called MIDI are claimed to be the best thing yet as a cure-all for the music maker's dilemma.

The theory is that computers, branded as the biggest work saver of all time, can be hooked up to all kinds of musical instruments and manipulated with greater control and proficiency than has ever been seen before. Many of you no doubt, only starting out in your interest in music, have found that hardware takes a back seat in a quest to end result. The fifty million dollar



question: How can a computer based system help alleviate some of these problems?

Foremost, as demonstrated in our introduction, any way of minimising cost would be a high priority. Also, to what extent is artistic control affected by the transition to a computer based system? How much will I have to learn to use the equipment effectively? How involved do you need to be to be able to use the gear?

Firstly, let's look at the financial angle of our plan. If a computer system were as easy to use as the traditional setup, by comparison how will I save money? There are two basic principles that give our system advantage over the traditional.

One, that by being based around electronic instruments, such as  
Australian Commodore Review 25

# MUSIC

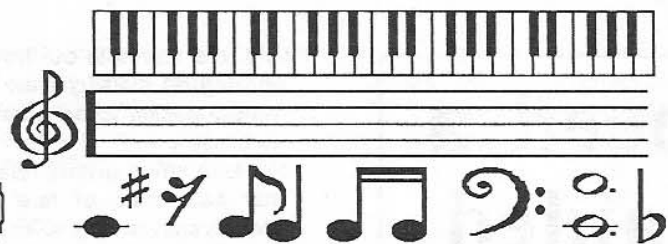

synthesizers and drum machines, you can take advantage most effectively of all the technological advantages that are pouring out from the development departments of the world's leading music companies, whose aim is to provide better quality and range of sounds at the lowest possible price.

Two, that as the inevitable happens, the industry will tend to support more and more computer technology. Even now, the latest products are becoming very software orientated. Eventually, many of the sound effects and sound generators currently available as hardware will become available as software on a disk for a fraction of the cost.

In real terms, the saving can be seen when you can readily find modules available with the guts literally ripped out of their parent keyboards at less than half the price. These modules can then be controlled by a computer and a mother keyboard, no need for the module to come with its own keyboard. A graphic example comes to mind with the DX7 and its sister in module form the TX7. The DX's price? Just shy of \$3,000. The TX7, capable of exactly the same sounds when controlled using MIDI, comes in at under half that price for around \$1,400. By the way, the DX is somewhat of an industry standard.

Suddenly, the equipment needed to make fantastic sounds has become available to ordinary people. Computer technology is already at the heart of most of the equipment that music companies are using. Most sequencers are 64 or 128 K computers devoted to controlling the sequencers or the playing order of notes. Multiply this 50% saving factor by the number of keyboards that you need to start and setup "your" sound, and you can see what kind of prospects there are for saving using the MIDI system.

Then there is the advantage of having a standard system for all the varying sounds that you might require to write your music.

If you want to have drum sounds, you've got to learn how to play the drums. If you want synthesizer sounds, you've got to learn how to manipulate all the controls to get the sound you want. Somehow in amongst this you've got to get your voice happening and write songs.

Many of these problems are fixed by using the MIDI system in that, if you have one keyboard as controller of all the different modules that have sounds, such as drums, bass sounds, synthesizer sounds, special effects sounds etc, then you only have to learn the technique of playing one medium, that is, a keyboard.

Eventually, there will be cheaper variations on what you can use as a controller. Even now there are fantastic gizmos such as a MIDI controller that is a guitar. There is also an excellent device spoken of in last month's MUSE section, called "The Voice Tracker", which actually converts your voice input into a MIDI signal to control other MIDI instruments. By far the easiest way for you to transfer your ideas into sounds produced to emulate whatever instrument you like. This more than compensates for having to learn how to make the computer control the instruments.

Many professional musos have found it a struggle to learn to develop technique for all the different instruments they need to be able to produce their sounds, and they can't see how having to learn how to work with a computer is going to help them in the creative process. But you can see that standardising all the varying sounds required by using a single controller keyboard will simplify matters and actually increase the speed of the creative process.

This is a very hard and fast attitude that is not held by a lot of people, in that they appreciate the subtleness of technique learnt by somebody who plays the acoustic instrument. The acoustic guitar, the electric bass. But consider the

advantages to someone who is learning from scratch.

Also, as interest develops in this area, we will find a lot more software becoming available; it will become increasingly more user friendly and also more efficient. With increasing interest data disks will become available providing tutorials on learning music and how to use this new technology and equipment, making it a lot easier for people to grasp and start using computer aided music systems.

Rounding out these points, it is easy to see how really excellent music making tools have become available for people at a price under a couple of thousand dollars. Even \$1,000 will land someone equipment and sounds that are leaps and bounds ahead of anything the music industry has ever had to offer.

Sadly, unnoticed is another feature that will appeal to any of you out there with strained backs. By mounting sound modules in a rack and sticking your computer in a road case, you will be able to take what really amounts to a mini recording studio around with you to your friend's place and even if you aren't getting paid as a member of the band. You tell me - isn't the idea of one keyboard and a box full of electrical gadgets more appealing than the half

---

***"It will become increasingly more user friendly and also more efficient!"***

---

truck load of a mega-buck investment that is currently required to get all those sounds you want?

Yes, the age is upon us where, for instance in a live situation, computers are able to handle such diverse things as lighting sequences, chord sequences for synthesizers, drum machines, settings for equipment, signal processing for sound reinforcement effects, P.A. effects. All that is needed is catalyst positive enthusiasm from people like you who are willing to put aside misconceptions and get on with the business of using really incredible technology to follow your favourite pastime, music making.

# Thinking Music...

## ...try PASSPORT design MIDI software.

### MIDI/4 plus™

Four Channel Recording Software  
for MIDI Equipped Synthesizers

MIDI/4 plus is the answer to your requests for an inexpensive MIDI recording system. It combines the power and performance of Passport's earlier MIDI/4, with new features that make editing and recording even easier.

Working alone you can compose, orchestrate, and arrange complete multi-track recordings using your synthesizer, drum machine, and personal computer. MIDI/4 plus allows your keyboards, drum machine, and analog tape recorder to work together. The four separate channels can control individual keyboards simultaneously, or the same channel can control several keyboards.

You also don't have to worry about playing a sequence over and over again until you get it right. When a note or measure isn't just the way you want it, you're just a click away from fixing it. With MIDI/4 plus single step playback, fast forward/rewind, and punch in/out features, the computer will help you edit any section of your work, without affecting the rest of the music you've already put down.

MIDI/4 plus makes recording and editing easy so you can spend your time and energy creating the music.

- Unlimited overdubbing on four separate channels
- Select from 16 different channel assignments
- Controls one or more MIDI equipped synthesizers
- Syncs to and from tape, MIDI, and drum machines
- Punch-in/Punch-out, Single Step Playback and Fast Forward/Rewind to facilitate editing
- Auto-correct to 32nd note triplets
- Fully polyphonic: digitally records all controllers including velocity, pitch bend, preset changes, aftertouch, and breath control
- Real time tempo control
- Over 6,000 note recording capability

### MIDI/8 plus™

Eight Channel Recording Software  
for MIDI Equipped Synthesizers

MIDI/8 plus is designed for professional musicians who need to control more than four MIDI channels at a time. Whether you're a single musician composing, orchestrating, and recording your own work, or a live band working together, MIDI/8 plus lets you build a truly sophisticated performance system. It combines studio quality recording with the power and flexibility of a personal computer.

Sync to an from MIDI, tape, and drum machines to create multi-track recordings of outstanding proportions. . .Overdub as often as you want on eight separate channels. . .Chain sequences to play over as a backup rhythm track. . .Use the beat clock and single step play back to punch in and out wherever you like, so you can edit accurately. MIDI/8 plus will revolutionize the way you compose and record music!

Since every nuance of your performance is digitally recorded in the computer, you can perform with confidence. Unlike overdubbing on tape, you'll have no loss of fidelity in your recording.

MIDI/8 plus allows your keyboards, drum machine, and analog tape recorder to work together. Because of its eight channel capability you can be rest assured that as new MIDI instruments become available, you won't be short on channels.

MIDI/8 plus is, simply speaking, the most efficient and creative way you can compose, orchestrate, and record your music.

- Unlimited overdubbing on eight separate channels
- Select from 16 different channel assignments
- Controls one or more MIDI-equipped synthesizers
- Syncs to and from tape, MIDI, and drum machines
- Sequence chaining, linking, and merging
- Punch-in/Punch-out, Single Step Playback and Fast Forward/Rewind to facilitate editing



# Music Software

## MIDI interface™

The Computer Connection  
for MIDI Instruments

The Passport MIDI Interface is the recognized standard interface in the music industry. That means that more software developers and synthesizer manufacturers are designing their programs around its specifications. When you use The Passport MIDI Interface, you have access to the largest library of music application software on the market.

The MIDI Interface syncs to and from MIDI, tape, and drum machines — everything you need for a flexible music system. With The MIDI Interface, you'll have the assurance that as the number of MIDI instruments on the market grows, your system will be able to expand with it. That's a great comfort in such a fast-moving industry!

The Passport MIDI Interface is for use with:

- Commodore 64 or Apple II +, IIe or Compatible Computers
- 1 or more MIDI synthesizers
- Conventional or MIDI drum machines
- Any analog tape recorder

For your local stockist contact: ROSE MUSIC Pty. Ltd. in your State

03. 699 2388  
Melbourne

02. 750 8999  
Sydney

07. 52 9422  
Brisbane

08. 223 3966  
Adelaide

09. 361 8922  
Perth

## Passport to new dimensions in music

by Ric Richardson

Back in the mid-seventies not many musicians associated computers with the development of their musical careers. Computers and high technology were the domain of engineers and scientists, not musicians. Then in 1976 the first computer controlled synthesizer was created and the music industry has never looked back.

This new breed of musician looked at music in a completely new light. After all, if the computer could help out writers, accountants and store attendants, assisting them to work faster and even more creatively, it should be capable of doing the more tedious chores of writing scores, even the not so tedious such as recording and even composing.

One of the first organizations to put together a software based recording package was Passport. With quite a heritage behind them, they have become very well known. In fact, enquiries to most music stores will find that their reputation is based around easy to use software, good pricing and due to their size, a slight lagging behind in the technology stakes. Which is to be expected since there have been an incredible deluge of advances in the last year in this field.

From a non-musician's point of view, or from that of a musician who is new to computer based music, the wide range of software available is a real boon. There are packages that allow you to write music in real time or in step time, recording as you go with your Commodore 64.

I have found their programs fairly bug free, and they have the advantage of using an interface that has become very popular with various software

manufacturers. So before we look at the software, let's have a look at the Passport MIDI interface.

### Passport MIDI interface

The Passport interface is a piece of hardware that lets your MIDI instruments talk to your computer and vice versa. Without it your computer is just a computer and your MIDI instrument is just another instrument. But with it in place you will be able to compose,

record, edit, score, print, study and store music more easily and enjoyably than ever before.

The fact that it is also a widely recognised standard as an interface configuration, means that more software developers and synthesizer manufacturers are designing their programs around its specifications. When you use the Passport interface you have access to the largest library of music application software on the market. Also of note is that the MIDI interface syncs up to MIDI tape and drum machines, which means that the computer can be slaved to a drum machine or to a tape recorder or even the reverse.

### Passport MIDI 4+ or 8+

The next step needed is some software to convert your computer into a recording medium. You can do this with the aid of the Passport MIDI/4+ or the MIDI/8+, depending on your requirements.

These two packages provide four or eight tracks of recording respectively. The 4+ package is the cheapest way I have seen for starting out in computer aided music with the full MIDI system. Working alone, you can compose, orchestrate and arrange complete multi track recordings using the synthesizers or drum machines. The four separate channels can control individual keyboards simultaneously or the same channel can control several keyboards.

There is also a feature that means you don't have to worry about playing a sequence over and over again until you get it right. When a note or measure isn't just the way you want it, you're only a click away from fixing it. With the 4+ single step playback, fast forward and



# MUSIC

## THE BEST GAME OF ALL



Computing, Mathematics, Art, Structure and Balance, infinite variation – Music is the teacher in the subtlest way, the way that gives great pleasure to all by their own natural expression.

And now in a single, simple to use module, ROLAND can expand your computer into a complete music system – drums, bass, polyphonic chord blocks and melody. Interfaced with keyboard and computer by uncomplicated midi connection and monitored on your own stereo system or portable cassette, the ROLAND MK S7 gives you the facility of a musical group in a recording studio\*. That's not only great fun in education for all, but even an instant no-fuss tool for professional or amateur composers to quickly build and preview compositions without the technology bogging down the creative process. The computer has come alive with the greatest game of all – MUSIC.

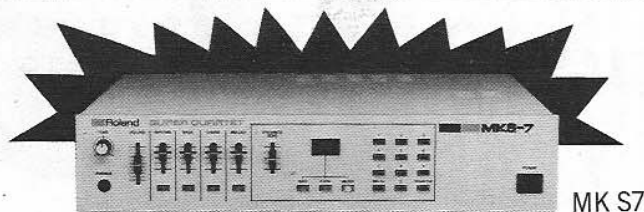

  
Roland

WE DESIGN THE FUTURE

\*YOUR COMPUTER WILL REQUIRE MUSIC SOFTWARE

# MUSIC

rewind, the punch in and out features for editing allow you to do some very elaborate editing of any section of your work without affecting the rest of the music you have already put down. With those four separate channels you have unlimited overdubbing and access to all sixteen of the MIDI channel assignments.

The program has a built-in feature so that it can sync to and from tape recorders, other MIDI instruments and drum machines. There is also quantizing which is done in the reverse of the music data program. All the recording is done in real time and then you can quantise after the fact to take away any faults. It also boasts full polyphonic MIDI, which means that it can digitally record all controllers including velocity, pitch bend, preset changes after touch and breath control features that are available on most synthesizers. And as to capacity, there is recording capability of over six thousand notes.

The MIDI8+ is a step beyond this, which allows for more sophisticated overdubbing and recording.

Recommended retail price for the MIDI 4+ is \$159 and for the 8+ \$259. Prices quoted for the interfaces range from \$250 through to \$400 depending on the features that you want and what particular computer you are using. But wherever you go, make enquiries of an interface and software package, making it a bit cheaper to buy both together.

## Passport MIDI Player

A nice extension of these programs is some software called the Passport MIDI Player, which is really a way of combining the data from the MIDI 4+ and video graphics. Making, in effect, computer music videos. The idea is that you use your data disk from your MIDI 4+ program, as your set of instructions for an album of music, to be played when you hook your system up to a synthesizer.



## COMPUTER AIDED MUSIC



Who can help me?  
What do I need?  
What is available?  
Where can I get it?  
How do you use it?

*Musicomp  
Marketing*

Let us help you.  
Just send a self addressed envelope with your questions, to us.  
We even have free demos of computer music if you send us a tape as well!  
Please note to send a large envelope and at least \$1:00 worth of stamps, we have a lot to tell you about!

P.O.Box 248, Lane Cove, N.S.W. 2066



**At Brashes  
Rockboard Rooms  
U2 can sound like UB40.**

**Or Lloyd Cole  
without all the commotion.**

**Or even put some bite  
into your Bach.**

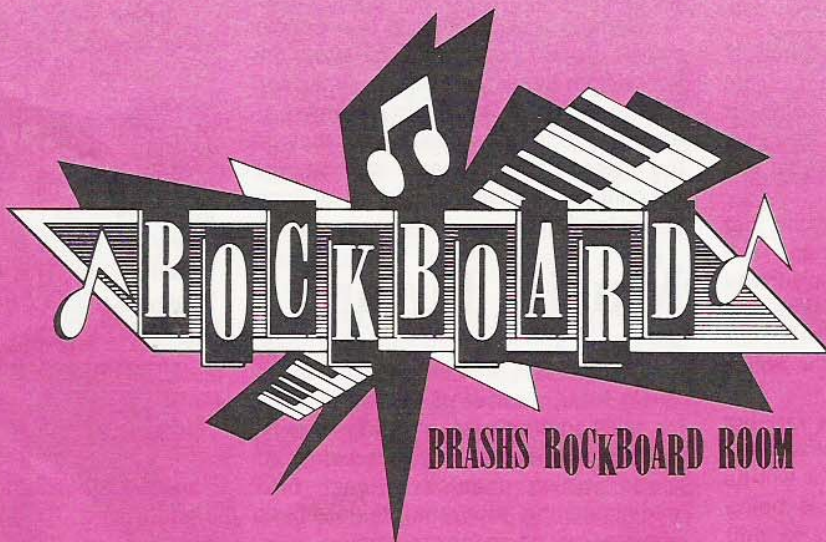

For everything in electronic and computer aided music.  
See the best brand names on show: Casio, Korg, Roland, JVC, Siel,  
Technics, Yamaha

See us at Brashes, Melbourne, Vic, and Brashes, Moorabbin, Vic, and Elveys,  
Parramatta, NSW. See us soon in Sydney and Brisbane.

# MUSIC

This can be accompanied with preset computer graphics. You can arrange and digitally store a whole set or album of music on disk and play it back through your MIDI system in any designated order. While the music plays, the video screen will dance with high resolution graphics directly keyed to the tempo and pitch of the musical score for dramatic visual presentations.

Once you have put your recordings on MIDI payout, you will find you can use them in a variety of different ways. You will have sets of music that can be used for instant accompaniment, performing or practising. You will also be able to locate your work easily, entertain your friends, and send out demos for nightclub gigs or publishing. The system can handle eight songs per data disk, it plays back arrangements in the order that you designate and synchronises music playback with real time computer graphics.

Out of the box it contains eight commercial arrangements of pre-recorded music.

MIDI Player is available for \$175 (rrp).

## Passport Lead Sheeter

An extension on these programs is the Lead Sheeter Program from Passport. This is a printing software program that transcribes what you play and prints sheet music in the treble clef or bass piano score form.

If you are looking for a program that can produce simple lead sheets and fake books, Lead Sheeter is both efficient and inexpensive. The program takes the music you play on your MIDI keyboard and inscribes in real time with the option of auto corrections.

If you want to play in one key but have the music scored in another, just tell that to the computer and it will be transposed. When the music is being transcribed, you can enter and edit lyrics, chord symbols, markings and titles on screen. It is an inexpensive program that produces quality sheet music that is easy to read. I have found this program quite good in that, even when you try to trick it, it does copy

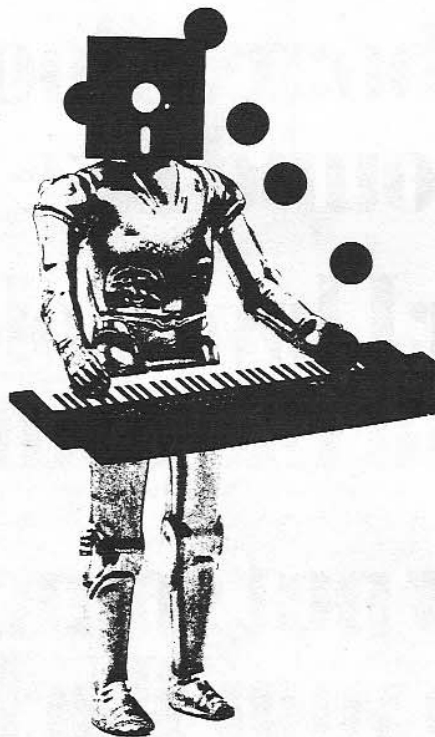

faithfully what you have played, mistakes and all. Lead Sheeter has a recommended retail price of \$129.

There is a big brother to this system called the Polywriter which takes the tracks from either the MIDI 4+ or 8+ and puts them on sheet music as well. For enquiries of these we will talk of them in the future. If you are eager to know why not contact Musicomp Marketing or Rose Music for details.

## Music Tutor

Of interest is another package called Music Tutor, a series of ear training aids for MIDI instruments covering chords, intervals and also a thing called a record keeper which enables a teacher to investigate the progress of individuals who are working on the program.

Chords and intervals teach you to hear harmonies and chord structures and identify them. The program can sharpen your listening skills, making it easier to pick out melodies and chord progressions. As you work with the

programs, both intervals and chords are presented visually and orally by name. You have the choice of making responses from either the computer keyboard or your MIDI synthesizer. Whether you are a teacher or self-taught student, the record keeper program lets you change any parameter in chords and intervals as well as keep and print accurate records of performance time, levels achieved and individual score charts.

Music Tutor is the ideal program to customise music education. The features include, in the chords program, drills on chord type inversion and top note, using full four voice chords. Chords can be replayed or arpeggiated up or down, and can use separate auditioning or soprano, alto tenor or bass fundamentals.

The intervals package features all intervals from unison to an octave. It uses intervals ascending or descending within or across an octave. It uses harmonic or melodic presentation as well as responding with interval name. Complete combinations of drill sections can be used. Each drill indicates if you have got the thing first time right and, if you don't, how many tries you've had at learning the lesson.

A nice touch is also a series of MIDI song albums that can use your MIDI synthesizer for playing back popular songs such as standards by the Beatles or popular music. Three MIDI albums are available, The Beatles, a collection of their greatest hits, Pops, a selection of today's popular music by top artists, and Sampler, a fine collection of Baroque masterpieces. This disk also allows you to playback your own compositions.



# Adventurers' Corner



## Voodoo Castle

by Ed Mehrrens

*Voodoo Castle* is the fourth in the Adventure International series and was originally written as a text base adventure by Scott Adams. It is now available as a high resolution adventure in the SAGA series, again by Adventure International. As with all of Scott Adams' adventures it is logical, if occasionally tricky, with that light hearted approach and humour, which is the hallmark of Scott Adams. *Voodoo Castle* is of

moderate complexity, with no really difficult puzzles to solve and no mazes to map. With all of the Adventure International series you only need to enter the first three letters of any word, for it to be understood.

The story line is simple and stright forward, Count Cristo lies near death in his castle after being cursed by "a person or persons, unknown," who appear well versed in the black arts of voodoo. Your aim is to remove this curse and restore Count Cristo. To do this you will need to visit nearly all of the 24 rooms of the castle, be careful in mapping as there are seven rooms simply called "a room in the

castle". Remember that Voodoo is a form of magic, so brute force will not work on any item associated with voodoo, however brute force will work on normal items. You do not need a vast knowledge of the black arts as all the information is available, if you can find it. So put on the record of Noel Coward singing "You do that voodoo, that you do so well", and enjoy *Voodoo Castle*.

My thanks to Garry Francis for supplying this information.

# INTERESTED IN AMIGA?

## 3 Books to lead the Field from COMPUTE!

COMPUTE!'s Amiga Programmer's Guide is a comprehensive detailed guide to programming the Amiga from Commodore. It is the reference you'll want next to you as you program. Whether you write in BASIC, C, or machine language, you'll find lots of useful information to help you tap the powerful features of the Amiga. Written clearly and concisely, COMPUTE!'s Amiga Programmer's Guide is packed full of useful information for both beginning and experienced programmers. It's the guide you'll find yourself referring to over and over again.

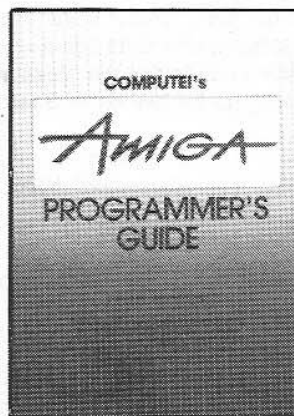

\$33.95\*

COMPUTE!'s Beginner's Guide to the Amiga is an easy-to-read tour through the most advanced personal computer available, the Amiga from Commodore. It guides you through the four kinds of hardware — input devices, CPU, memory, and output devices — explaining step by step the mysteries of each, with comparisons you'll understand at once.

The Workbench, the graphics-based interface which offers icons, pull-down menus, and multiple windows, isn't the only way to operate Commodore's Amiga personal computer. A more direct method of control is also available. Called the CLI (Command Line Interface), it provides added power and flexibility.

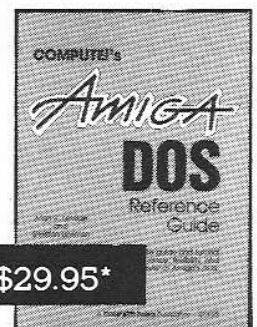

\$29.95\*

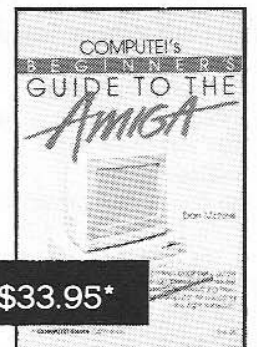

\$33.95\*

Available from leading bookshops. Keep A Lookout For More Amiga Books From COMPUTE!

# Holt Saunders

9 Waltham Street, Artarmon, N.S.W. 2064  
\*Prices quoted are recommended retail only.

Ph: 439 3633

## Specific Clues

- (1) *In the dark?*  
50,60,31,26,60,21
- (2) *What am I doing here?*  
42,3,20,15,3,16
- (3) *The window keeps slamming shut.*  
65,40,60,24,14,26,60,29
- (4) *Can't move the ju-ju bag?*  
56,60,21
- (5) *Still can't move the ju-ju bag?*  
25,60,33,35
- (6) *Is it boarded up?*  
27,60,47,23,3,60,45,55
- (7) *Is it still boarded up?*  
48,60,39,22
- (8) *Gratings or bars a problem?*  
61,60,51,52,26,60,29
- (9) *Still can't get past the grating?*  
46,60,8
- (10) *Can't move the massive stone door?*  
20,3,61,60,49,26,60,15
- (11) *Can't read the plaque?*  
65,40,3,17,43
- (12) *Letters too small?*  
61,60,7,28
- (13) *Crack in the wall a problem?*  
62,60,35,4
- (14) *The medium keeps vanishing?*  
58,36
- (15) *Can't get out of the Medium's room?*  
20,60,5
- (16) *Statue a problem?*  
53,65
- (17) *Can't lift the kettle?*  
32,9,6,38
- (18) *Can't move the animal heads?*  
61,60,7,59
- (19) *Can't open the safe?*  
56,60,44
- (20) *Exploding chemicals a problem?*  
61,60,54
- (21) *Can't fit through the tiny door?*  
37,3,19,60,12
- (22) *Sweep a problem?*  
46,30
- (23) *Can't find a doll?*  
42,60,63
- (24) *Can't break the curse?*  
65,10,60,47,23,1,34,1,57,1,24,  
14,1,31,3,18
- (25) *Still can't break the curse?*  
43,47,23,41,35,1,13,15,1,62,57,  
1,64,11

- (1)
- (2) A
- (3) AND
- (4) BAG
- (5) BALL
- (6) BE
- (7) BROKEN
- (8) BUTTON
- (9) CAN
- (10) CARRY
- (11) CHANT
- (12) CHEMICALS
- (13) CIRCLE
- (14) CLOVER
- (15) COFFIN
- (16) CONTENTS
- (17) DARK
- (18) DOLL
- (19) DRINK
- (20) EXAMINE
- (21) FIREPLACE
- (22) FIRST
- (23) FOOT
- (24) FOUR LEAF
- (25) FREE
- (26) FROM
- (27) GET
- (28) GLASS
- (29) GRAVEYARD
- (30) HIM
- (31) IDOL
- (32) IT
- (33) JU-JU

- 34) KNIFE
- (35) MAN
- (36) MEDIUM
- (37) MIX
- (38) MOVED
- (39) NAILS
- (40) NEED
- (41) ON
- (42) OPEN
- (43) PLACE
- (44) PLAQUE
- (45) POCKET
- (46) PUSH
- (47) RABBITS
- (48) REMOVE
- (49) RING
- (50) RUB
- (51) RUSTY
- (52) SAW
- (53) SAY
- (54) SHIELD
- (55) SHOVEL
- (56) SOLVE
- (57) STICK
- (58) SUMMON
- (59) SWORD
- (60) THE
- (61) USE
- (62) WAVE
- (63) WINDOW
- (64) YELL
- (65) YOU
- (66) ZAP

## Bastow Manor

Please help me, I'm stuck. I have gotten into the house, worn the suit of armour, retrieved the brass key from the mailbox and got the bucket of water. Now I would like to know where do I go next or what do I have to do to find the 'treasure' that's supposed to be hidden in Bastow Manor.

T. Rogers  
Carlingford, NSW.

## Ultima II

Dear Sir,

I am writing to you concerning the game "Ultima II" by Sierra On-Line because I am nearly at my wits end trying to destroy Minax. I desperately need help with the following:-

1) How on earth do I increase my initial attributes points? I am now a level 63 elven warrior but my attributes have not risen by even one point in all the time I have been playing. What am I doing wrong?

## Zork III

I have had Zork III for eight months and so far I have found it exciting, fun and hard.

**Q.19.** Once you get the key from the key room, how do you get back to the usual shore of the lake?

**Q.20.** What does the flickering indicator with changing Roman Numerals for?

**Q.21.** What is the man in the boat visible from Flathead Ocean for?

**Q.22.** How do you win the game?

**Q.23.** What do you do when the lamp runs out?

**Q.24.** Is the time machine needed?

**Q.25.** Is the man with the rope who wants to help you up needed to win the game?

## Hints and Tips

*Don't stay in the lake too long.*

*Don't go back in time too far.*

*Explore all shores of the lake.*

*If the Roc Monster appears, get out of the lake.*

*If the hooded figure appears in the land of Shadow and you choose to fight and you are injured, move away quickly.*

*If you do not want to fight the hooded figure, just move away before he comes.*

*What surrounds you in the Royal Puzzle?*

*Try things with them.*

Justin Sullivan  
Manly, NSW.

2) Where on earth is the spaceship to be found? The only one I have located is in Minax's castle in the land of Legends, but I cannot get to it. Is this the one I am supposed to use and if so, how?

3) What is the purpose of the four time doors inside Minax's castle?

4) What is the use of the Reflect armor? Is it only for some of the monsters or does it have other uses?

5) Lastly, the old man under the tree. Is this bloke senile or what? All he seems to be able to say is I'm an old man.

Please, could someone help with some tips to help me to stop from becoming a simpering wreck.

Mark Knight  
Bankstown NSW

# SATURDAY COMPUTER SERVICES

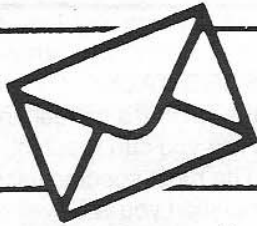

## MAIL ORDER LIST

This is our new up to date catalogue with all the latest releases.

For reasons of space we can't include *everything*, so if you don't see what you want on this list, please telephone us on (02) 398 5699 and enquire about price and availability.

### Games

#### ADVENTURE QUEST

Explore middle earth and reach the black tower. 200 locations. Text.  
\$29.95 (D or C)

#### CONAN THE BARBARIAN

Your goal is to find and destroy the villainous Volta. 7 levels.  
\$39.95 (D)

#### DALLAS QUEST

Hi-Res adventure. JR Ewing takes you in search of 2 million dollars.  
\$39.95 (D)

#### DRAGONRIDERS OF PERN

Alliance forming and battle constitute this fast paced game.  
\$29.95 (D)

#### DUNGEON ADVENTURE

200 locations and 100 puzzles will keep you off the streets. Text.  
\$29.95 (D or C)

#### GHOSTBUSTERS

You've seen the movie, now you too can get slimed. Back off man!  
\$34.95 (D) \$29.95 (C)



#### Perry Mason: The Case of the Mandarin Murder

Victor Kapp is dead - murdered. Laura is in jail, charged with his death. And facing trial very, very soon.

You'll have to work fast - and smart. Dig into people's lives.

The first interactive mystery to use the world-famous criminal lawyer created by Erle Stanley Gardner. It also represents a major breakthrough in interactive fiction: the cooperation of the characters and jury changes as a direct result of your interactions with them.

In addition, you can do virtually everything a court room lawyer can do.

Price: \$49.95 (D)

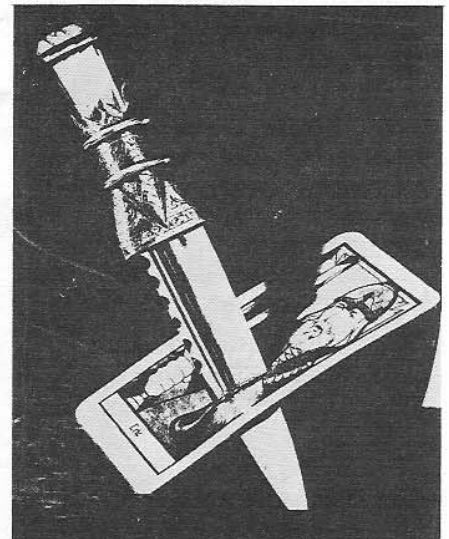

#### Nine Princes in Amber

They tried to kill you - and when that failed, they stuck you in a private hospital with enough drugs to keep you out cold for the rest of your life.

Well, almost enough drugs.

You are a prince of Amber, fighting for the throne against your eight brothers and four sisters - all of them treacherous. Yet you must gain the support of some of them if you are to succeed. And that will be as complex and tricky a game of politics as you ever hope to play. Especially without your memory.

Price: \$49.95 (D)

I have carefully looked over the entire range of software and hardware being offered in this mail order list, and believe that it is of good quality and excellent value for money.

Andrew Farrell, Editor

# SATURDAY COMPUTER SERVICES

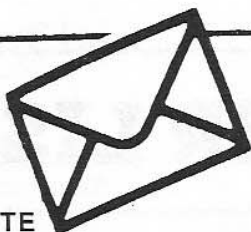

## INSTITUTE

Freudian solutions may help you escape or you die a 1000 deaths. \$24.95 (D)

## JUMPMAN

See the Aust. Commodore Review for low down and up top of this game. \$29.95 (D & C)

## OIL BARONS

Board game as well as software. Dallas at home. Big game. \$69.95 (D)

## PITSTOP

Classic car driving action game. Strategy and nerve are necessary. \$19.95 (C)

## POLE POSITION

Experience the thrills of Formula 1 as you race against the clock. \$29.95 (C) \$39.95 (D)

## POTTY PIGEON

Make your home to the tune of great music and superb graphics. \$19.95 (C) \$24.95 (D)

## RETURN TO EDEN

First Level 9 game with graphics. 250 locations, many puzzles. \$29.95 (D or C)

## SNOWBALL

Huge adventure with over 7000 locations awaiting you! Text. \$29.95 (D or C)

## SPACE ACE 2101

Strategic arcade real time game. Trade before you fight. \$19.95 (C) \$24.95 (D)

## SPY HUNTER

Hunt spies till the cows come home and the chickens roost! \$29.95 (C)

## SPY VS SPY

Classic from Mad now comes home. Ingenuity + steady hand required. \$29.95 (C) \$34.95 (D)

## STRIP POKER

R rated computer game - sizzling graphics! Have to see to believe. \$29.95 (C) \$39.95 (D)

## SUICIDE EXPRESS

The future of the human race is in your hands once again. Arcade. \$19.95 (C) \$24.95 (D)

## THEATRE EUROPE

Combination of strategy and arcade action in this popular new game. \$29.95 (D or C)

## ZIGGURAT

The most bewildering maze ever created. Is there a way out? \$24.95 (D)

## SUPERMAN THE GAME

Superman and Darksied are pitted against one another in the ultimate battle of good against evil. 'Super' graphics and split screen action. \$29.95 (C) \$34.95 (D)

## BRUCE LEE

Meet the master of the arts in the most artful form of self defence. His body is his weapon, and now he's ready to join forces with you. \$29.95 (C) \$39.95 (D)

## THE GOONIES

Instead of playing the role of one Goonie, you must know and control the mischievous role of all The Goonies. See ACR Vol 3 No 1 for full review. \$29.95 (C) \$39.95 (D)

## ZORRO

Multiple levels, traps, escape routes and tunnels are only some of the obstacles that form part of your quest. See ACR Vol 3 No 1 for full review. \$29.95 (C) 39.95 (D)

## HARDBALL

Baseball that's so real and true to life, it's like you can reach out and touch it. The most spectacular sports simulation you will ever play. See this issue for full review. \$29.95 (C) \$34.95 (D)

## LAW OF THE WEST

If you've ever wanted to strap on a six-shooter, pin a tin star to your chest and match the exploits of Bat Matterson or Wyatt Earp, then this is your chance. See Vol 3 No 1 for full review. \$29.95 (C) \$34.95 (D)

## KENNEDY APPROACH

You are in charge! It's your job to get all the aircraft and passengers on the ground, or on the way safely. The first speaking simulation that allows you to communicate between pilot and control tower. See Vol 2 No 8 for full review. \$39.95 (D)

## THE ISLAND CAPER

This is the sequel to the original hit computer game "Mad Magazines official Spy vs Spy". If you've played Spy vs Spy, then don't miss this exciting real time episode. \$29.95 (C) \$34.95 (D)

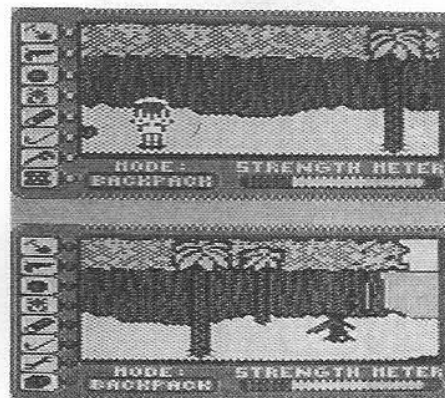

# SATURDAY COMPUTER SERVICES

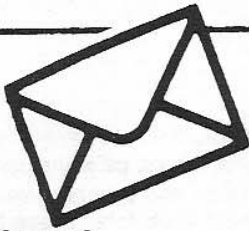

## Educational



This is only a selection of the software available for mail order.

Please see the next issue of *The Australian Commodore Review* for more.

As advertisements must be prepared well ahead of publication time, prices are subject to change without notice.

**METEOR MULTIPLICATION**  
From DLM.  
By using the keyboard, the player must aim his spaceship at the closest meteor, work out his answer, type it in, then shoot and move on to the next closest meteor until the screen is empty. It sounds simple, but it really is excellent. It makes education fun and exciting.  
\$39.95

Other educational games available from DLM are:

- Alien Addition
- Alligator Mix
- Demolition Division
- Dragon Mix
- Minus Mission

\$39.95 Each

## ORDER FORM

Postage and packing on each item: please add: 1.25 for software  
1.50 per box blank disks  
2.50 per book  
3.75 for hardware listed

Please apply for bulk rates.  
Orders greater than \$475 obtain a FREE subscription to ACR for 1 year, or FREE postage and packing.

Please list each item that you require, then add your name and address and post together with cheque or Bankcard number to:  
Saturday C.S. P.O. Box 189, St Pauls, Randwick, NSW, 2031  
(02) 398 5699



NAME.....	ITEM	COST
ADDRESS.....	.....	.....
.....	.....	.....
.....	.....	.....
.....	.....	.....

Payment \* Cheque enclosed ..... Add pBp -----  
or \* Bankcard

TOTAL .....

.....  
bankcard                      expiry date                      signature

## GAME REVIEW



Movie themes really are getting a hammering. Here's another that hopefully doesn't rely on the big names to make it a hit. Hopefully you saw the movie, because if you didn't you missed out on a very entertaining experience. There was plenty of action, adventure and a few really beautiful musical interludes. The game has managed to capture some of the atmosphere of the movie with the use of several of the musical scores including the Power of Love and Back to the Future.

Marty is your typical teenage American movie hero who has managed to take himself back in time using a time machine built in the De'Loran automobile. If you're going to travel you might as well go in style, right? Well, *Back to the Future* travels all the way into the 1950's where Marty's parents are still enjoying the fun and freedom of school. However, due to a minor mishap he has managed to mess up his parents' first meeting. Unless he can get them together again he will be history, or not history as the case may be.

All your favourite characters out of the movie are there - Marty, Doc, Biff, Lorraine and George - the greatest no hoper you could ever hope to meet. To get George and Lorraine together you will need to make use of a few objects scattered about the set. Once again, if you've seen the movie you'll understand the effects of these a little better. Your efforts are primarily hampered by Biff, who occasionally lands a punch between your eyes that leaves you out cold. He is also chasing Lorraine, but she's not interested in him - he's just one of the local bullies.

Your best defences against Biff are the skate board or an equally well placed punch. He is difficult to outrun. Play takes

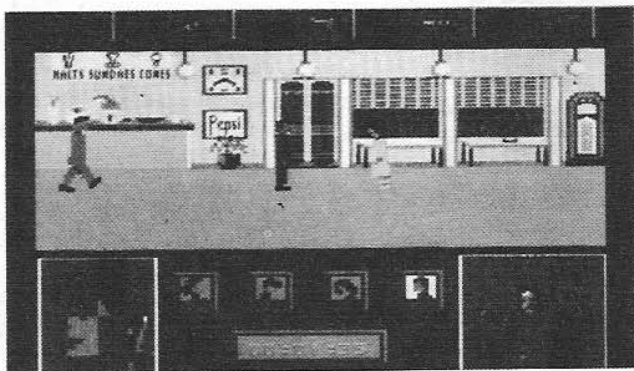

place between several main locations all joined by a street. These include Doc's house, the school, cafe and dance hall.

The screen display is divided into several areas. The top half displays each of the available objects. These turn yellow when you are next to them, and white if you decide to pick up and use them. There are five items in all - a love poem, spacesuit, cup of coffee, guitar and skateboard. Marty is quite handy with the skateboard, which is an excellent means to get from one end of the set to the other without any hassles from Biff.

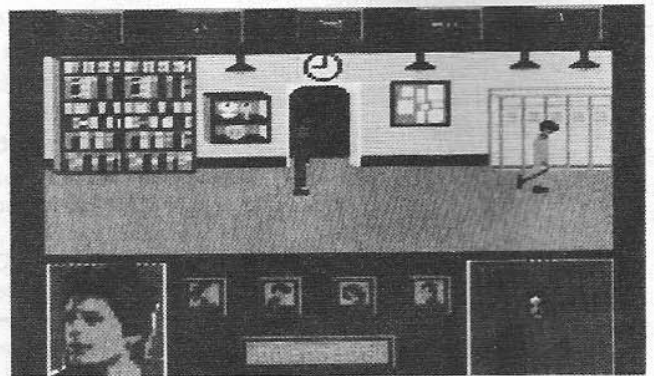

At the screen's centre is a side on view of your playing area. Below that is from left to right, a photo of Marty, a picture of the other four characters, a family photo and at the very bottom, the time. The photo's give you an indication of how you're faring. If they begin to disappear, you know that things aren't working out. The character pictures light up depending on what characters you and the objects you may be holding influence.

Overall, BTF is a well presented game, with pleasing music and reasonable graphics and animation. Whether or not it will attract the same buyers as other big movie name titles remains to be seen. Somehow, I think it's just a bit too difficult to play. I did a lot of walking around, and didn't seem, despite my best efforts, to achieve anything much.

Machine : *Commodore 64*  
 Game : *Back to the Future*  
 Publisher : *Electric Dreams*  
 Distributed: *Imagineering*  
 Price: Disk \$44.95  
 Cassette \$22.95

Graphics :	90
Sound :	88
Originality :	96
Presentation :	92
Addictiveness :	86
Overall :	92



# The Transformers

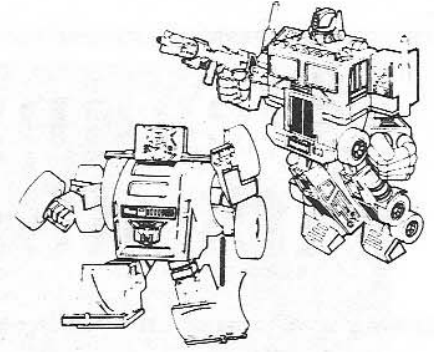

Earth has been invaded by powerful robots from Cybertron. A battle is raging between the good Autobots and the evil Decepticons.

The Autobots have an energy crisis and while repelling the Decepticons they must collect four pieces of the Autobot energy cube. These four pieces look like small glowing boxes. Once finding these pieces you must take them to the Autobot Centre, which is a large square that appears on your screen at the start of the game. You have a time limit of about twenty minutes, so be quick! At any one time, the maximum amount of pieces you can hold, is one.

Unfortunately during the long struggle only five Autobots remain. They are; Optimus Prime (the leader), Jazz, Hound, Mirage and Bumblebee whereas the Decepticons have perfected Robo-Cloning, which reproduces any number of

them you destroy. However, the five heroes have one thing going their way, Defensa-Pods. Under these they may seek shelter and regain their strength.

You look side on to the game which consists of stairs and platforms raised and lowered all over the place. Towers and tanks are also spread around.

The music in this game is very good and reminds me of the theme music out of the cartoon series. The music unfortunately only lasts during the loading time and first minutes of the game.

At the beginning I suggest you practice flying and avoid brick structures as you will find this useful later on when searching for the cubes. When meeting up with Decepticons don't try blasting

them as you will find this very unsuccessful. Instead, I suggest ramming them if your shield level is still high. If it isn't avoid them at all costs!

Be warned! Once your strength or shield level runs out you will burn up. Each Autobot has different strengths and weaknesses when negotiating with planet's surface. Experimentation will improve your skill greatly.

This game is a lot harder than is first evident in its early stages. Overall, I feel that this is a very good game with a medium level of difficulty and a minimal level of strategy. This game is a must for all transformer fan and collectors.

In the map below I have shown you a way to get to one piece of the energon cube.

Distributed: OziSoft  
Price: \$29.95

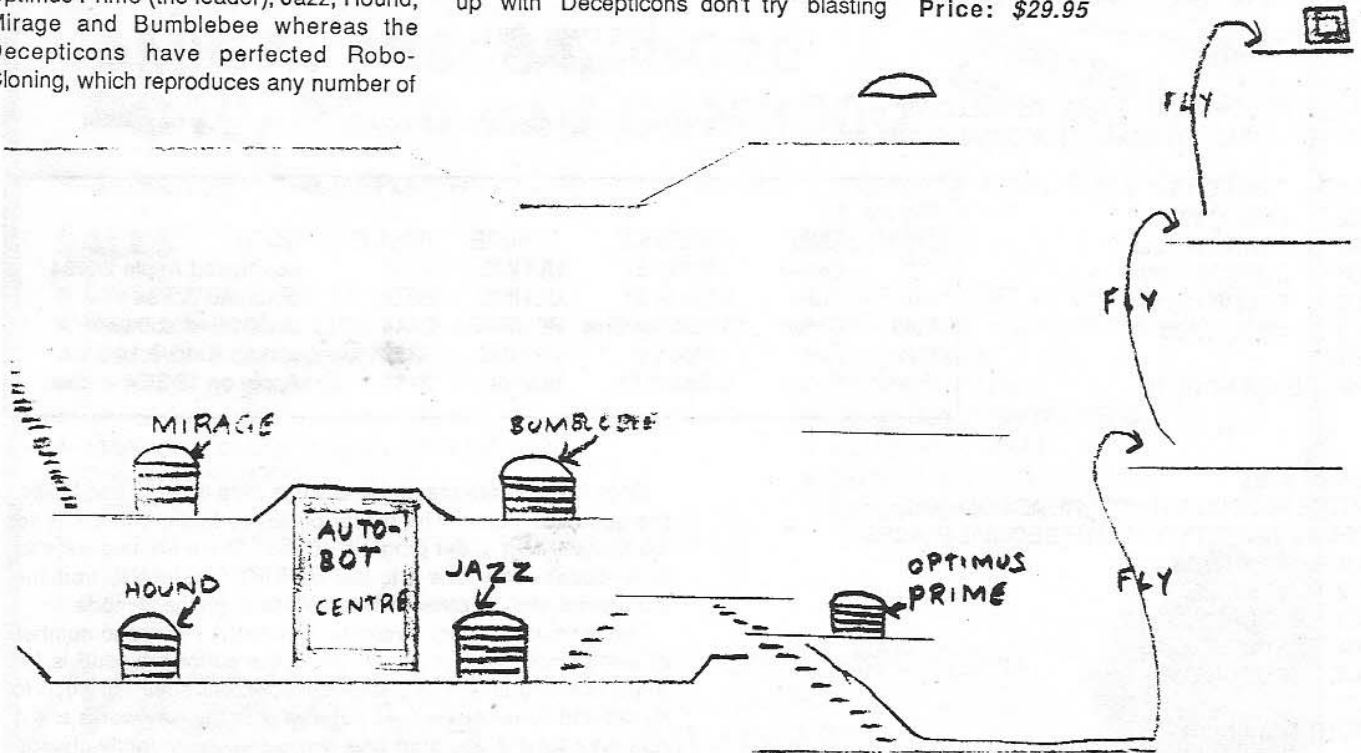

# Dealing with dBase

by Gene Stephan

This issue I will look at an alternative method for creating data files for Mailmerge. Although dBase has been quite extensively talked about in many publications, it is well worth mentioning the basics in a small amount of detail. Table 1 gives a summary of a number of commonly used commands.

The first task to tackle is to CREATE the structure of the database. This should be done with some care as subsequent alterations to the structure are messy and better avoided.

As an example we'll take a small business situation - specifically the keeping of customer data to use together with form letters. The business we have is a computer shop (what else!) and with sales in the hundreds per month, we would like to invite people to have their machines serviced free of cost just before the warranty expires. (Well, it is a hypothetical case.) Due to the numbers involved, Australia Post gives us a discount if the mail is pre-sorted.

The structure must include names, addresses and a note on each of the purchases made. So, enter dBase and CREATE:

```
A>dbase <RET>
.create main
ENTER RECORD STRUCTURE AS FOLLOWS:
FIELD  NAME,TYPE,WIDTH,DECIMAL PLACES
```

```
001  FIRST,C,15
002  LAST,C,20
003  ADDRESS,C,25
004  SUBURB,C,20
005  PCODE,C,4
006  NOTE,C,120
007
INPUT DATA NOW? N
```

```
.create mlist
ENTER RECORD STRUCTURE AS FOLLOWS:
FIELD  NAME,TYPE,WIDTH,DECIMAL PLACES
001  FIRST,C,15
002  LAST,C,20
003  ADDRESS,C,25
004  SUBURB,C,20
005  PCODE,C,4
006
INPUT DATA NOW? N
```

Australian Commodore Review 40

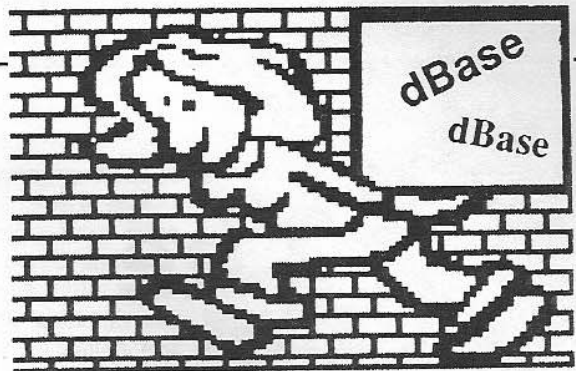

I have created two files in order to simplify seeing what is happening to the data. MLIST is identical to MAIN with the exception of the NOTE field.

You may also notice the PCODE field has been made into a character field rather than a numeric. This does not affect the INDEXING or the selection of record by < or >. It does have the advantage of allowing multiple field indexes.

dBase will not allow INDEX on a mix of character and numerically defined fields. In practice, I often leave PCODE fields numeric. The advantage here is in a type of safety check. PCODE should have no character input, so the computer beeps if a letter is inadvertently entered. In such applications, postcode is usually the last field with a width of 4. This makes character errors difficult to detect at the time of data entry.

A large note field is extravagant, and in the case outlined, data could have been entered far more economically under a number of smaller fieldnames. With dBase, space must be watched. In the case of the MAIN file, 204 characters will be stored to disk per record irrespective of whether or not anything more than 1 character is entered.

Now, enter some data into MAIN:

```
. USE MAIN <RET>
. APPEND <RET>
```

For those uncreative individuals, Figure 1 may be helpful.

Figure 1

FIRST	LAST	ADDRESS	SUBURB	PCODE	NOTE
Bill	Brown	1 White St	ULTIMO	2222	purchased Apple 2/3/84
Joe	Bran	2 White St	ULTIMO	2222	purch //c 3/3/84
Fred	Green	17 Sunny Cres	BOURKE	2444	considered software
Mike	Pink	1 Moon st	CAIRNS	3333	screen & drive 14/5/84
Pete	Purple	6 Beach St	BONDI	2111	Apple on 12/3/84 + disk

Once the files are created and some data entered into MAIN, the good bits begin. The power of dBase lies in the ability to manipulate data under program control. There are two ways to enter dBase code. One is to use MODIFY COMMAND from the dot prompt and the other to enter WS through the N mode.

I prefer going through Wordstar due to the increased number of edit commands. However, using the editor provided is far more convenient as the dBase environment does not need to be left and code can be tried out easily. Either way works and it doesn't matter if you start one way and subsequently change to the other. All that matters is the syntax, and if WS is used

that it be used in the N mode and the file has the .CMD extension.

So to aims:

1. Select the data
2. Sort the data
3. Convert the data into Mailmerge form

And the code:

```
* file called MMCON
* for MailMerge CONvert
* will be on disk as MMCON.CMD
*
```

```
* getting started with data
* and outputting to b:
*
```

ERASE

? 'Working'

?

SET TALK OFF

SET DEFAULT TO B

USE MLIST

\*

```
* decide selection criteria
*
```

```
APPEND FROM MAIN FOR $(NOTE)="3/84"
*
```

\*

```
* will select for that date form
* anywhere in the note field
*
```

\*

```
INDEX ON PCODE + LAST TO MDEX
*
```

\*

```
* the above sorts the records
*
```

\*

```
* now to create the mailmerge
* file
*
```

\*

```
COPY TO MMLIST DELIMITED WITH ,
ENDDO
```

Save the program and then from dBase try

```
.DO MMCONV <RET>
```

The disk should spin for a while and the computer do an amount of processing. At the end of all the activity, the dot prompt will return. On the data disk, however, two new files will have been created. One should be MDEX.NDX and the other MMLIST.TXT.

To check what happened, enter:

```
.USE MLIST
```

```
.LIST PCODE, LAST
```

```
00005 2111 Purple
```

```
00002 2222 Bran
```

```
00001 2222 Brown
```

Three of the five records were added into MLIST and they are sorted.

You can now enter WS and use the same form of letter as discussed in the last issue. Note only to change the .DF command to .DF MMLIST.TXT.

Next month in the CP/M column I will present some code to automatically find duplicate records in dBase files. Until then, I'll leave you thinking.

## Commonly used dBase Syntax

**APPEND:** command which allows entry of new records.

**APPEND FROM:** appends records from one file on to the end of the one currently in use.

**BROWSE:** command which allows edit of several records on the screen at one time.

**CLEAR:** command which returns dBase to a state comparable to when just booted. All variables released, all files closed.

**COPY TO:** command to copy a database (file). Can be used for selective copying.

**COUNT:** will return the number of records in a database. Can be used selectively.

**CREATE:** command to create a new database (.DBF file)

**DELETE:** command which marks a record (or range) for deletion. Deleted records appear marked with a \* and are not lost until the PACK command is issued.

**DISPLAY:** displays the current record.

**DISPLAY ALL:** displays all records pausing every fifteen.

**DISPLAY FILES:** displays the files on the currently logged drive.

**DISPLAY MEMORY:** displays the variable names and the space used.

**DISPLAY OFF:** displays the records without number.

**DISPLAY STRUCTURE:** displays the structure of the currently open database.

**DO:** command used to run a dBase program.

**DO WHILE .NOT. EOF:** command to continue to process until the end of the file (last record) is reached. Then go to the next instruction.

**EDIT:** command which allows modification to a specific record.

**ERASE:** command to clear the screen.

**GO BOTTOM/TOP:** command which allows to go immediately to the last or the first record.

**INDEX ON .. TO:** command to create an index file. INDEX ON LAST TO LAST1 will index on the field LAST and create a file LAST1.NDX.

**INSERT:** command to insert a new record within a file (rather than append to the end).

**JOIN:** command which allows two similar databases to be joined.

**LIST:** command to display all records and data. Other form useful to create lists. USE MAIL INDEX LAST1 <RET> .LIST LAST, PCODE<RET>

**MODIFY STRUCTURE:** command to change the structure of the current database. Use with care as all records are lost. If records are to be saved, COPY first, then MODIFY, and finally APPEND FROM.

**PACK:** command which irrevocably removes all records marked for deletion.

**QUIT:** command which must be used when exiting dBase. Failure may result in loss of data.

**RECALL:** command which undeletes a record.

**SET PRINT ON:** command to direct the following output to the printer.

**SET TALK OFF:** command to hide results of commands.

**SKIP:** command to proceed to the next record or as otherwise directed.

**STORE:** command to store data to a memory variable. Used commonly where a set of macros is being defined. Try STORE 'SET DEFAULT TO B:' TO DR <RET>. Now, when the dot prompt returns try &DR <RET>. The default drive should change to B:.

**SUM:** sums the values in a numeric field.

# What is a database file?

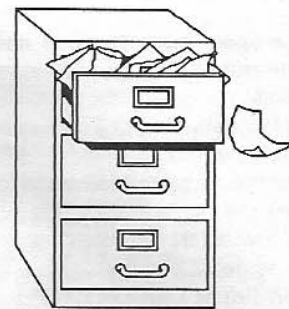

by Errol Chopping

IN MANY CASES the documentation accompanying computer file management programs deals only with the mechanics of file creation (how to do it), and novice users may not be aware of the many concepts which must be taken into consideration when creating and using a file.

In this article I will attempt to explain some important concepts related to computer databases. My aim is to give you, the computer user, a "just below the surface" view - not too technical, not too vague - of the structure of database files which may help you to create better files and to make better use of existing ones.

## An analogy

In many ways, a computer database file resembles an index card system.

If you are/were about to set up such a file you would purchase a plastic flip-top box and a packet of blank cards from the newsagent. You would have, in the back of your mind, an idea of how many cards you would be likely to need and how much information would be written onto each card. This knowledge would guide you in your choice of boxes and size of cards.

For the sake of this example, let us assume you wanted to create a file containing the names of your friends and relatives, the birthdate of each and a note recording the gift you bought each person on their last birthday.

It would be appropriate to allocate one card to each person and to write each person's name, birthdate and gift on their card. You would probably then store the cards in the box in alphabetical order so that you could quickly find a required person or in chronological order so that you could quickly find a certain birthdate.

## The translation

Let's now take the example above and translate it into computer terms.

The whole box, once you have started actually writing details on the cards, would be dedicated to recording people's names, dates and gifts. It would be hard to then use the completed cards for another purpose, say to record serial numbers of your household appliances or details of tax deductible expenses. For this reason the computer will require you to give the whole box a FILENAME. You may call it "GIFTS" or "BIRTHDAYS" or whatever.

In computer terms, each card in the box is called a RECORD. In computer files all records are identical in layout. Different programs allow you different numbers of records (cards) and just as you have to buy a box which is big enough for all your cards, so you also have to decide on a computer program that will allow you to maintain enough records in each file.

Each entry on each card will be called a FIELD (or sometimes CATEGORY or HEADING). The cards you bought may be only big enough for the three categories "Name", "Birthdate" and "Gift" or there may a number of blank lines left unused on each card. So it is with computer filing systems, some allow many fields, some relatively few.

## PART 1: Creating the file

When you are setting up a database file on a computer you must define these parts of the file so that the computer knows how to record the information. Usually the program you use provides a

step-by-step set of instructions or prompts which lead you eventually on the stage where it can store the file on disk.

The list which follows outlines these steps and attempts to make clear some matter you must consider as you go through.

### 1. What is the name of the file?

Usually the first thing the program requires is the **Name** of the file. This name will eventually be used as the filename when the data is recorded onto disk. Some operating systems allow long names for files and allow punctuation marks, numbers and spaces; others allow as few as eight characters with no punctuation marks.

You should think of a name that is easy to remember and is in plain English. Sometimes the program will require you to type the filename from memory and it is important that you know what it is without having to try different possibilities. Usually the programs allow you to scan the filenames on disk and some will make it possible to pick up the file using the cursor control keys or from a menu.

Be careful of operating systems which do not accept lower case filenames or that automatically truncate long filenames without informing you.

### 2. How many files are on each record?

This is very important.

You must specify how many categories are to go onto each record and in some cases there is no way of increasing or decreasing the number of fields once the file has been created.

Fortunately, modern database programs usually allow you to add a new category later or to delete ones you no longer require. Often the program will deduce the number of fields by counting the number of field names as you type them in.

The computer database uses the fields as key elements when sorting and searching the file. It is therefore very important that you put some thought into what headings are necessary in your particular application. Here are some hints when deciding what headings to include in a file:

a) If you are recording people's names then you should consider two separate fields - one for the Given Name and another for the Surname. This will allow you to Sort the file alphabetically on the basis of Surname and yet still get print-outs containing their full name. If you place the full name in only one field then you will have to write entries like "Bloggs Bill" in order to get the names sorted correctly.

b) Include a field to contain each person's title: Mr, Mrs, Ms, Dr, Sr, Br, Sir etc. This could be useful if you decide to merge the file later with a form letter or print address labels.

c) If you are recording addresses then ensure there is enough room for the complete address by creating about four fields called "Address1", "Address2" etc. You would be surprised where some people live.

d) Don't waste time, effort and computer memory by creating fields you don't need, and don't record sensitive or personal data about people when this is not appropriate.

e) If you will require arithmetic calculations based on the total number of records or the number of records falling into different types, then it may be necessary to include "Counter" fields which contain numbers that can be totalled at print time.

## 3. Setting field lengths

Some programs will require that you specify the number of characters which are allocated to the data on each field. If this is the case then you have to take care that there is enough room for long entries. For example, if you have the field

"Name" in your file then you may need space for about 25 characters (some people have long names!)

In many cases you can change the field length later if you wish, but be careful that this is possible before you waste too much time.

## 4. Entering data

If you get to this stage, you have created the file and are now ready to enter the data. This seems easy enough, but there are still a few traps especially if the database program is not very sophisticated.

As stated earlier, if you have only one field for people's names then it may be necessary to enter their surname first so that they appear in correct alphabetical order when the file is sorted.

If you are including the date in the file then the program may require that you enter it in a certain way. For example, *Appleworks* needs to have the date in the form Month/Day/Year if you are going to sort the records chronologically.

If there is no special date function in the database program, then it may be helpful to enter the date in the form YYMMDD. That is April 15, 1986 would be written 860415. When you sort this field from lowest value to highest (or alphabetically) the records will appear in chronological order.

## Testing the file

You will get a very sick feeling if you spend hours entering data only to find that the file does not work properly.

If the program does not allow you to add or delete fields or change their length after you have recorded some information, then you should enter ten or so records, print the file, sort it, search for special records etc.

If the structure you have created is not working then you will be in a position to create it again without too much time lost.

## Saving the file

Database programs usually come in one of two types. Those that save the information on disk each time a record is

changed and hold only one record in memory at a time, and those that hold the whole file (all the records) in memory while you are working.

The first type usually allow more records per file (sometimes only restricted by disk space) and if the power is cut there may be only one record change lost. Although these programs have the advantage of large storage capacity, they are usually slow when searching or sorting.

The latter type (memory resident files) are able to store less per file (the memory space is smaller than the disk space) but are faster at sort time. You must take care to save the complete file to disk before you switch the computer off. You should also force the program to save the file regularly during a work session because even the briefest power failure can vaporize all the modifications since the last save.

Modern database programs will usually prompt you to save the file when you quit if you have made changes. Some even interrupt with messages like "You have made 57 changes to this file, do you wish to save it?"

## PART 2: Using the file

So much of the information relating to using the database depends on the program you are using. In presenting this material I have attempted to clarify those points which are common to most of the packages available.

## Sorting data

Most programs will allow you to sort the file using any of the fields as the key. Naturally, you choose which field you want here. It may be appropriate to sort using two fields. This case arises when you need major groups of data in a print-out and information within those groups also in order. For example, the following table shows both fields sorted alphabetically but with the "City" field sorted within the "Country" field.

Country	City
Australia	Brisbane Hobart Melbourne Sydney
Britain	Glasgow London Southampton

In order to obtain such an arrangement you usually need to sort the field of lesser importance first (ie "City") and the field of greater importance last (ie "Country").

This technique may not work in some cases, it depends on the sorting routine the program uses. Generally however, the principle to follow is "Sort the least important field first".

## Finding Information:

### Scanning

All database programs have the ability to search and find records. Some allow you to scan the whole file looking for occurrences of a certain word or words. If you use this feature then you will sometimes retrieve unexpected records.

For example, if you have a file of magazine articles about animals and you scan this file looking for all the occurrences of "fish", then you may find the program retrieves articles written by Joan Fisher because the word "fish" occurs in the author's name.

Likewise, scanning a file of people's names and addresses for someone named "Brown" may well deliver all those people who live in Brown Street or Brownsville as well.

### Selecting records

Usually, searching is done by specifying a particular field by name, then selecting some sort of test, then typing a value or word for comparison. Sounds complicated. doesn't it? Here is an example:

If you want to find people from your people file called "Brown" and that's all,

then you would specify the selection by first choosing the "Surname" field, then setting the test to "equals" and finally typing in the comparison value "Brown". In this way you would have made a selection rule which reads

"Surname" equals Brown"

Things can always go wrong. This test will NOT find those people with the name "Browne" or "Browning" or "Erskine-Brown". I find it safer to use the test "contains" in most cases. Specifying the rule

"Name contains Brown"

may deliver a few unnecessary records but you are more likely to find the person you want without having to go through the rule setting task more than once.

### Consistent data entry : For searching

Computers are high speed morons. They do what they are told with the information they are given. For this reason it is important to enter information in a consistent manner so that searching and sorting yields worthwhile results.

If more than one person will be typing entries into the database, then there will have to be some coordination so that they all use the same abbreviations and contraction. If you were searching for the people living in the state "N.S.W." in an address file then people will NOT be found if they:

- a) do not live in that state or
- b) the state has not been typed in or
- c) the entry reads "NSW" or "N.S.W" (without the final dot) or
- d) the entry "N.S.W." has been placed in the wrong field.

You can see that there is a lot that can go wrong.

### For sorting

In the computer's memory, lower case characters have different code numbers from their upper case equivalents. When the file is sorted alphabetically entries written in upper case will float to the top of that list.

People entering the data should be made aware of this so that they always enter the information using the same case.

This aspect of data entry is quite important when it comes to print-outs which calculate values based on alphabetical groups. The field to be grouped must be sorted alphabetically before the calculations will work and you will find that items like "school" and "School" and "SCHOOL" will form different groups.

## Security

If the file contains important information or has taken a long time to develop then you must make backup copies regularly.

For example, most Country Councils record customers' details on computer. The files could account for some tens of thousands of customers. They usually keep one set of disks on the computer, a second set locked in a fire-proof safe and a third set in another building! You may not need to follow their example to that degree but the principle is the same. Keep a backup copy in a different location and update it regularly.

Have you heard of computer crime? If you are recording sensitive or personal information then keep it away from unauthorized eyes. Sample print-outs thrown into the office tidy bin could be a source of information leaks. Use your own judgement on this aspect but don't neglect it completely.

## Summing up

These days computer programs are fairly easy to use, and if all else fails you could always read the documentation accompanying the program.

I will be writing other such articles in the future - one of which will be concerned with transferring data between Database, Spreadsheet and Word Processor programs.

This paper is aimed at those computer users who wish to get the best and most reliable use from their database files. I hope the few points I have raised in it do help in that regard.

# TED Register Description

Here, now, to thrill your grandmothers back into their childhood, is a complete description of the various functions of the TED graphics chip employed by both the Commodore 16 and the PLUS/4 computers. With this invaluable knowledge you will be able to discover the full potential of your computer.

The TED chip sits at \$FF00, (65280 in decimal). By poking various values into these registers, interesting effects may be obtained. One of these is the ability to use custom character sets, as described in a previous issue.

## Internal Timers, Register 0 through 5

TED contains three 16 bit decrementing interval timers, each partitioned into 2, 8 bit registers. To initiate a new count value, loading the low Byte inhibits counting until the high Byte is loaded. The timers decrement at a 894 KHZ rate for NTSC television systems, 884 KHZ for PAL systems. Each counter generates an interrupt upon decrementing to 0. The sequence for writing to the timers should be:

Disable all interrupts  
Write low Byte  
Write high Byte  
Enable desired interrupts

Care should be taken that long time intervals, more than 125u seconds, do not occur between writing the low and then the high Bytes.

**Timer 1** is a sequence interval timer. Registers 0 and 1 when written to initiate the reload value of the timer. When timer 1 is decremented to 0 the next count occurs from the reload value. Reading

Registers 0 and 1 gives the current count value.

**Timers 2 & 3** are free running counters. Upon decrementing to 0 the timers roll over to FF and continue counting. Writing to timer 2 & 3 registers loads directly into the active count. Reading these registers yields the current count.

## Register 6

Bits 0-2 of this register determine the vertical scroll position. For a normal 25 row picture with no scroll these bits should be a '3'. Bit 3 is the 24/25 row select. A '0' in this bit corresponds to 24 rows and a '1' yields 25 rows. For vertical scroll to occur, bit 3 should be cleared and bits 0-2 all set. Decrementing bits 0-2 moves character position up scrolling off the uppermost character row. Bit 4 is the blanking bit. Setting this bit to a '1' gives a normal picture. Setting it to a '0' blanks the screen and disables all fetches from occurring, allowing for the system clock to run at twice the frequency (1.788MHZ NTSC, 1.768MHZ for PAL) except for 5 refresh cycles per raster line.

**Bits 5 and 6** are display mode Bits. Setting Bit 5 to a '1' enables Bit mapped mode, while setting bit 6 enables extended color mode. Bit 7 is a bit used for I.C. testing and must remain a '0'.

## Register 7

Bits 0-2 determine the horizontal scroll position. A '0' in these bits allows for no scroll. To institute scroll bit 3 of this register, the 38/40 column bit, should be set to '0'. This displays 38 columns and scroll can occur cleanly. Incrementing the 3 LSB of this register

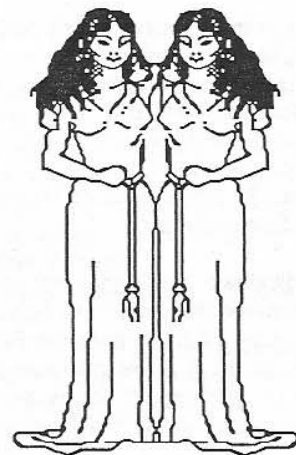

pans the character positions to the right.

**Bit 4** is multicolor mode bit. Setting this bit to '1' enables multicolor. The freeze bit is bit 5. Setting freeze high stops TED from incrementing the horizontal position, the timers and the vertical position. The system is forced into single clock (894KHZ) and system refresh of dynamic rams. Bit 6 is PAL. Setting this bit high forces NTSC mode, low corresponds to the PAL mode. Bit 7 is the reverse video off bit. Under normal conditions, bit 7=0, there are 128 character locations. The reverse video character is implemented by setting the MSB of the video matrix pointer to a '1'. This enables the TED chip to invert the character data and thus reverse video. If an alternate character set of 256 locations is desired, this bit can be set high turning the reverse video feature off and allowing the MSB of the video matrix to define the additional character locations.

## Register 8

This register is the keyboard latch. Writing to Register 8 scans the keyboard lines and latches the appropriate data. Reading the register, reads the latched data.

## Register 9

The interrupt register indicates any TED interrupt source. Possible interrupt sources are:

- Bit 1** raster interrupt-compares raster register to active count
- Bit 3** timer 1 interrupt-timer 1 has decremented to '0'
- Bit 4** timer 2 interrupt-timer 2 has decremented to '0'
- Bit 6** timer 3 interrupt-timer 3 has decremented to '0'

**Bit 2** indicates a light pen interrupt. The TED computer does not have light pen. This bit is for future expansion. Bit 7 is the interrupt bit. It is the inversion of the interrupt pin. Writing a '1' to the interrupt register clears the individual interrupt bit.

**Register 10**

Register 10 is the interrupt mask register. The individual mask bit corresponds to each of the possible interrupt sources. Setting the bit high enables interrupts to occur. The LSB of this register is the MSB of the raster register. (see Register 11 description)

**Register 11**

In an NTSC television system, 262 raster lines are produced (0 to 261), 312 for PAL (0-311). To detect all possible raster lines a 9 bit register is needed. Register 11 contains the low order 8 bits of this raster register. Register 10 contains the MSB. The raster register is an interrupt source. The raster register value is compared to the current vertical line count. An interrupt is generated 8 cycles before the character window. For a 25 row display the visible raster lines are from 4 to 203.

**Register 12**

Register 12 contains the 2 MSB of the cursor position register. Bits 0 and 1 correspond to cursor bits 8 and 9.

**Register 14**

Register 14 contains the low byte of Voice 1 frequency base. All TED sound generators produce square waves.



**Register 15**

The low order eight bits of the frequency base for the second voice source are contained in this register. This voice is selectable for either white noise or another square wave generator. This selection is available in Register 17.

**Register 16**

This register contains the 2 MSB of Voice 2.

**Register 17**

Register 17 has 4 bits of volume control ranging from 0 = OFF to '8' being loud. Also 3 voice selects are available. Voice 1 select, Voice 2 square wave select and Voice 2 white noise select. The MSB of this register is a bit used for testing. The sound reload bit will clear the sound toggle flops and initiate the reload value of each voice to initialize the active sound count during the appropriate voice incrementing time.

**Register 18**

This register contains the three bit bit map mode address base, the ROM/RAM bank bit, and the 2 bit MSB of voice 1

frequency base. The bit map base determines where in the memory map the bit map dot data can reside. Bits 3 through 5 correspond to BMB0 to BMB2. During TED dot fetches in the bit map mode, BMB2 will become A15, BMB1 - A14, and BMB 0- A13. The ROM/RAM bank bit, bit 2, will force TED dot and character fetches from either ROM or RAM. A '1' in this bit will force ROM execution, a '0' will force RAM.

**Register 19**

This register contains the character base, force single clock bit, and the status bit. The force single clock bit, when set high, inhibits the PH out of TED from doubling frequency during horizontal blanking. The status bit is a read only bit indicating the state of the 2 phantam Registers 62 and 63. If this bit is high it indicates that TED is operating for the ROM bank memory. This bit does not indicate where TED will fetch character or dot information is coming from.

**Register 20**

The 5 bit video matrix base, bits 3 through 7, comprise Register 20. The video matrix base determine the memory mapping of the video matrix pointers and the attribute data as shown:

A15	A14	A13	A12	A11
VM4	VM3	VM2	VM1	VM0

The attribute and video matrix fetches occur on the raster line preceding the character row (attribute) and the first raster line of the character row. During these fetches TED will DMA the processor and take complete control of the system bus for both halves of the clock cycle, for 40 consecutive clock cycles.

**Register 21**

This register contains a three bit luminance code and a four bit color code for background Register 0. This allows for eight separate luminance levels for each 16 colors.



## C 16/PLUS 4 TECHNICAL NOTEBOOK

### Register 22

Register 22 contains the same data as Register 21 for background Register 1.

### Register 23

Background Register 2 data is stored here.

### Register 24

Register 24 is comprised of luminance and color data for background Register 3.

### Register 25

Luminance and color information for the exterior register (border) is stored in Register 25.

### Register 26

The two MSB of the character position reload register are bits 0 and 1 of this register. The character position reload increments by forty for each character row completed. For example, during the first character row this register will contain '0'. Upon completion of the eighth raster line of the row the character position bit map reload register will be updated to 40.

### Register 27

The low byte of the character position reload register is located here. (see Register 26).

### Register 28

The register contains only 1 bit, the MSB of the vertical line register. The vertical line register contains the current raster line being displayed. For NTSC systems this register will count from 0 to 261, for PAL, 0 to 311.

### Register 29

The low byte of the vertical line register is contained in Register 29.

### Register 30

Register 30 is the horizontal position

register. Register 30 contains the upper 8 bits of the nine bit register. The LSB increments at a rate too fast to be of any use in programming. Since the horizontal position register actually increments from 0 to 455, Register 30 will contain values of 0 to 228. Negative true data is to be written to this register while positive true data is read.

### Register 31

This register contains the 4 bit blink rate register and the 3 bit vertical subaddress register. The blink rate register contains the current count of the blink rate timer. This register is incremented once per screen. On overflow a 2HZ signal is generated initializing the cursor reverse video and any flashing characters. The vertical subaddress counts the eight raster line per character row.

### Register 62 and 63

These registers do not physically exist on the TED chip. A write to these locations controls the TED system memory map. Any write to Register 62 result in ROM being selected in memory locations \$8000 (HEX) to \$FFFF (HEX) excluding \$FD00 (HEX) to \$F3FF (HEX) for I/O space and TED space. The TED chip will generate the necessary chip selects and inhibit CAS until a write to Register 63 occurs. Upon this occurrence, the same locations \$8000 (HEX) to \$FFFF (HEX) excluding \$FD00 (HEX) to \$F3FF (HEX) are banked to RAM. CAS occurs when appropriate and chip selects are suspended.

All TED registers, unless otherwise noted, are read/write. It should be noted that care should be taken when writing to Register 26 through 31. These are internally controlled registers. Writing to them can result in a flicker on the screen.

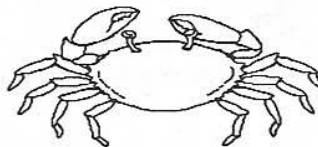

Typing Tutor \* Easy  
Load and Run \* Sprite  
Animation \* Split  
Screen Utility \* Latest  
News \* Bulletin Board  
Update \* and lots more

In the  
**FOURTH** issue of  
**Australian  
Commodore  
Review Disk  
Magazine**

All on one disk -  
for only \$12.95

And if you missed out on  
the previous issues of our  
Disk Magazine, now's  
your chance! There are  
still some available, at the  
special price of \$10 each.

To: The Australian Commodore Review  
Top Rear, 4 Carrington Road,  
Randwick, NSW 2031  
Phone: (02) 398 5111

Please send me .....copies of  
the FOURTH issue of your disk  
magazine at \$12.95 each (plus 50  
cents for postage and packing).

Please send me  
.....copies of the FIRST issue  
.....copies of the SECOND issue  
.....copies of the THIRD issue  
at \$10 each (plus 50 cents for postage  
and packing).

I enclose a cheque/money order for  
.....  
OR  
My Bankcard number is  
.....

Name.....

Address.....

.....Postcode .....

## USER GROUPS

# COMMODORE USER GROUPS

### NEW SOUTH WALES

#### SYDNEY

Sydney Users Association  
36 Western Avenue, Blacksland 2774  
Contact: Mr P McGinnus (02) 925 8239

#### SYDNEY CITY

Sydcom  
PO Box 1542, Sydney 2001  
Contact: Mr Ian Allen (02) 920 5832, Mr Dean  
451 1916

#### GREYSTANES

Vic 20 User Group  
1 Gipps Rd, Greystanes 2145  
Contact: Mr Sam Axiak (02) 636 2080

#### HORNSBY

Hornsby User Group  
P.O.Box 1661, Northgate,  
Hornsby Heights 2077  
Contact: Daryl French (02) 476 4391, Jill  
Rassack

#### CASULA

Southern Districts User Group  
3 Lucille Crescent, Casula 2170  
Contact: Mr L Toms (02) 602 8691

#### CUMBERLAND

Cumberland Micro User Group  
Granville Library  
Contact: Mr Steven O'Neil 639 5430

#### NEWCASTLE

The Compu - Tech Computer Club  
P.O.Box 43, Islington 2296  
Contact: Mr G Rayner (049) 433352

#### MAYFIELD

Newcastle Computer User Group  
136 Maitland Road, Mayfield 2304  
Contact: Mr C Dibblu (049) 67 5700

#### HAWKESBURY - RICHMOND

12 Inverary Drive, Kurmond 2757  
Contact: Richard Farrell

#### WOLLONGONG

Wollongong User Group  
155 Jacaranda Avenue, Figtree 2525  
Contact: Mr P Stanhope (042) 28 8580

#### DENILIQUIN

Deniliquin User Group  
139 Davidson Street, Deniliquin 2710  
Contact: Mr Patterson (058) 81 3014

#### HOBARTVILLE

RAF Base Richmond  
Squadron 486, 45 Luttrell st  
Hobartville 2753  
Contact: R.J. Nicholls

#### JINDERA

Albury/Wodonga User Group  
Drumwood Road, Jindera 2642  
Contact: Beth McIntyre (060) 26 3357

### ACT

#### BELCONNEN

ACT Commodore Computer User Group  
PO Box 455, Belconnen 2617  
Contact: Mr Hunter (062) 86 1057

#### WATSON

Watson User Group  
25 Kerford Street, Watson 2602  
Contact: (062) 41 2316

### VICTORIA

#### HORSHAM/WIMMERA

Commodore User Group  
P.O.Box 4082  
Horsham 3401  
Contact: Darrell Kennedy

#### LAVERTON

Laverton User Group  
School of Radio  
RAAF  
Laverton  
Contact: Mr Ken Mould (03) 368 2569, (03) 311  
8713

#### BENDIGO

Bendigo User Group  
5 Board Court  
Kangaroo Flat  
Contact: Mr Lukeis (045) 477 593

#### MORNINGTON

Mornington District Users Group  
Tanti Park Community Centre  
Mornington  
Contact: Mr Harding (03) 783 3007

#### NORTHCOTE

Melbourne VIC 20 User Group  
PO Box 252  
Northcote 3070  
Contact: John Ruddoch

### VICTORIA SUB GROUPS

#### DONCASTLE

Athenaeum Hall  
Doncaster Rd  
Doncaster 3108  
Contact: Frank Martin (03) 419 1924

#### KNOX

Coonara Community House  
20 Willow Rd  
Upper Fern Tree Gully 3156  
Contact: Frank Martin (03) 419 1924

#### SPRINGVALE

Dingley Community Centre  
Marcus Rd  
Dingley 3172  
Contact: Frank Martin (03) 419 1924

### PRAHRAN

Prahran Primary School  
67 High st  
Prahran 3181  
Contact: Frank Martin (03) 419 1924

### WAVERLEY

Alvie Hall  
Alvie Rd  
Mt Waverley  
Contact: Frank Martin (03) 419 1924

### WESTERN SUBURBS

Please ring 369 4068  
for waiting list

### MACHINE CODE GROUP

Blackburn Scout Hall  
Koonung Rd  
Blackburn Nth  
Contact: Frank Martin (03) 419 1924

### WESTERN AUSTRALIA

#### Dealer Based

#### LEEDERVILLE

W.A.C.C.U.A.  
PO Box 31  
Leederville 6007  
Contact: Mr N Headlam (09) 381 4398

#### LESMURDIE

VIC Ups  
4 Sheild Road  
Lesmurdie 6076  
Contact: Mr G Padfield (09) 451 4629

#### KALGOORLIE

VIC Ups  
28 Dart st  
Boulder 6432

#### ROCKINGHAM

VIC Chips  
48 Hercules street  
Rockingham Park  
Contact: Dave West (095) 27 3954, Ron  
Teague (195) 27 6558

### QUEENSLAND

#### SOUTHPORT

Southport User Group  
Scarborough Street  
Southport  
Contact: Mr Fitzpatrick (075) 32 0061

#### SPRINGWOOD

Sld Commodore/PET User Group  
PO Box 274  
Springwood 4127  
Contact: Mr G Perry (07) 38 3295

#### Dealer Based

#### COOLANGATTA

Tedita Pty Ltd  
116 Griffith Street  
Coolangatta 4225  
Contact: Mr P Hamill (075) 36 6722

## USER GROUPS

### COMMODORE USER GROUPS

#### MOUNT ISA

Commodore Computer User's Club  
3 Crystal Street  
Mount Isa 4825  
Contact: Mr Steve William, Mr Peter Robbins

#### TOWNSVILLE

Townsville Users Group  
1 Paxton Street  
Townsville 4810  
Contact: Mr Tone Moore 72 6454

#### IPSWICH

Commodore User Group  
P.O.Box 298  
Ipswich 4305  
Contact: 201 8118, 202 3601

#### ROCKHAMPTON

Commodore User Group  
50 Ocean Parade  
Yeppon 4703  
Contact: Mr Goodsell

#### SOUTH AUSTRALIA

##### NTH ADELAIDE

S.A Commodore User Group  
P.O.Box 427  
Nth Adelaide 5006  
Contact: Mr W Dobbings (80) 255 4044

#### CLARENCE GARDENS

Commodore Computer Users Association of  
S.A.  
PO Box 60  
Clarence Gardens  
Contact: Earl Rowan

#### NORTHERN TERRITORY

##### DARWIN

Northern Territory Commodore User Group  
349 McMillans Road  
Anula Darwin 5793  
Contact: Mr I Diss (089) 27 9208

##### NHULUNBURY

Northern Territory User Group  
PO Box 1195  
Nhulunbuy 5797  
Contact: Mrs Sue Cuthbertson

#### NEW ZEALAND

##### CHRISTCHURCH

Christchurch Commodore User Group  
63 Rowses Road  
Christchurch NZ  
Contact: Mr J Kramer (NZ) 88 5533

#### MOUNT ROSKILL

Commodore Users Group  
Hazel Avenue  
Mout Roskill  
Contact: Mr Roger Altena 278 5262

#### NELSON

Nelson Vic User Group  
PO Box 860  
Nelson  
Contact: Mr Peter Archer

#### NEW PLYMOUTH

E R Kennedy  
c/- New Zealand Synthetic  
Fuels Corp. Ltd  
Private Bag  
New Plymouth

#### AUCKLAND

Combined Microcomputer User Group  
PO Box 6210  
Auckland

#### PAPUA NEW GUINEA

PO Box 9211  
Ho Holo  
Port Moresby

## DEALER DIRECTORY

### Cockroach Turbo-Rom

Price: \$42 (inc. postage etc.)  
Speed up program loading and saving  
with TURBO-ROM, available for C64,  
SX, 128, 1541, 1570/1. Works with 1  
or 2 Drives. Vic switch compatible.  
Does not tie up cartridge socket.  
Works with printer connected. (Some  
fast loaders don't).

**COCKROACH SOFTWARE,**  
PO BOX 1154,  
SOUTHPORT, 4215.  
Telephone: (075) 32 5133  
A/H (075) 32 4028



— LETTERS —  
ANDREW FAN MAIL  
FARRELLS.

## DISKETTES SPECIAL

5.25" SSDD	\$25
5.25" DSDD (10)	\$32
3.5 SSDD (10) Fuji	\$61
3.5 DSDD (10) Memorex	\$81

Memorex/Nashua/Fuji with lifetime guarantee

**MODEM 1200/75, 300, phone \$280**  
Free terminal, file transfer and  
Videotex Software

Bankcard and M/Card Accepted  
**NEIL CARPENTER**  
**COMPUTING P/L**

(02) 818 4220 (7 days)  
PO Box R401 Royal Exchange 2000  
Carriage: Overnight Courier \$7 anywhere.

### FREE POSTAGE!

Data Development runs Sydney's largest  
regular software sales. Now we bring better  
value to mail order. No more \$1 off retail  
prices and \$5 on postage! Our prices are  
recommended retail prices or less, with free  
postage. **COMPARE!**

#### Introductory Specials

Elite	T 36.95	<input type="checkbox"/>	D 45.95	<input type="checkbox"/>
Lord of the Rings	T 41.95	<input type="checkbox"/>	D 41.95	<input type="checkbox"/>
Infiltrator	T 27.95	<input type="checkbox"/>	D 28.95	<input type="checkbox"/>
Revs	T 36.95	<input type="checkbox"/>	D 45.95	<input type="checkbox"/>
Worm in Paradise	T 27.95	<input type="checkbox"/>	D 28.95	<input type="checkbox"/>
A.C.E.	T 27.95	<input type="checkbox"/>	D 31.95	<input type="checkbox"/>
Paradroid	T 27.95	<input type="checkbox"/>	D 31.95	<input type="checkbox"/>
Newsroom			D 73.95	<input type="checkbox"/>
Epyx Basis Programmers Kit			D 45.95	<input type="checkbox"/>
Paperclip/SPELLPACK			D 81.95	<input type="checkbox"/>
Epyx Fast Load Cartridge			D 36.95	<input type="checkbox"/>

To order, tick appropriate boxes, cut out ad  
and send cheque money order or credit card  
information to Data Development, 9 Welch  
St, North Manly, NSW 2100.

Name .....

Address .....

.....

Bankcard/Mastercard No .....

I authorise you to debit my credit card

Signature .....

# INFILTRATOR

CREATED BY CHRIS GRAY

## Your mission

1. Rescue the captured scientists being forced into building Super-Weapons and destroy the enemy research lab.
2. Blow up the enemy air base where dangerous new fighters are being assembled.
3. Destroy the tank factory.
4. Steal the war plans and destroy enemy headquarters.
5. Assassinate the enemy leader.

Infiltrator offers a new generation in computer games and graphics design, with multiple screens and multiple games composed into one of the most enjoyable real life scenarios that you will play on your Commodore 64. Commodore Review called it "Excellent Graphics design" and we're sure you'll agree.

Cockpit screen



Multiple Screens



Distributed by

**Ozi Soft**™

Suite 33/8-24 Kippax Street  
Sunny Hills, N.S.W. 2013

**OUT  
NOW**