

**SOUTHERN DISTRICTS COMMODORE  
USERS CLUB INC.**

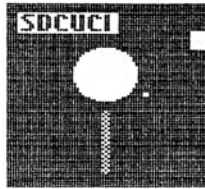

**THE DISPATCH DISK  
JULY 1990**

**EDITORIAL**  
18/7/90



Hello everyone,

At the last meeting the president, Robert Cloosterman mentioned that if you kept all your edition's of the DISPATCH DISK, one could place these editions in a book form as a handy reference book.

The idea being that one could refer back to this book for information and handy hints to improve one's computing skills. We could name this book, the DISPATCH DISK HANDY REFERENCE BOOK. What is needed is for ideas, hints and other useful information from members of the club, to be handed in, to be included into the book.

A section will be set aside for PEEK and POKE numbers, such as:- POKE 53280,1 and POKE 53281,4 which are the border and background colour pokes. All useful pokes and peeks plus hints, could be supplied by members and visitor's, as they come across them.

Also SYS numbers and games cheat hints, can be included. If member's could see a committee member about passing on their ideas, and hints, to be included into the book. It would be greatly appreciated. At some latter date, the club will publish a book containing all the handy hints and information.

**CONTENTS**

SUBJECT	PAGE
EDITORIAL	1
LIBRARY NEWS	2
A THANK YOU	2
PRINTSHOP GRAPHICS	3-4
1570 DEVICE SWITCH	5
COMPUTER PUZZLE	6
COMMITTEE NOTES	7
DISPATCH DISK NOTES	8
(LOOSE) CLUB NOTICES	

The club now has a 128 DISK LIBRARIAN. Michael Tippins has offered his services as Librarian. Alex Morrison has become a committee member in the position of ASSISTANT SECRETARY. The club is still requires a EXPERT REGISTER. If you are interested, please see Robert Cloosterman.

In this edition of the DISPATCH DISK, you will see that there is a notice about our user's group. This notice has been supplied to members, for them to be displayed in a prominent place. EG:-On notice boards at WORK/BUSINESS/SUPPERMARKETS/SHOPS/ETC(in your local area).

The idea of this notice is to make more people aware of our user group, so as to gain more members and interested parties, for the benefit of the club, and individuals in it. Which means more knowledge and ideas will be gained for better computing and skills.

We have supplied two notices on one page. If you require smaller notices, for notice boards with limited space or just extra notices, approach a committee member about obtaining reduced size or extra notices. The club will greatly appreciate your help in advertising our group.

The NOTES FROM THE COMMITTEE should be carefully thought about, as they are important information from the committee members, this information concerns all members from the club.

JAN VAN DE BELT - EDITOR



# LIBRARY NEWS



Hi! I am back! After a 2 month absence in which I had a good dose of this year's virus and spent 6 weeks visiting my father in hospital 6 times a week, (and that doesn't leave much time for computing, I can assure you!). I will be back in action at this meeting with my instant disk service.

And I hear that I have finally got a volunteer to be '128 Librarian'. That's excellent as I am certain that there is much excellent 128 PD material around - and now you will be able to get access to it.

To celebrate tonight's demonstration of Print Shop, I have been able to get hold of a new PD Print Shop 3 block Graphics disk (only \$3 tonight). It has 134 new graphics, ...4. new fonts and 6 new borders on it. I am going to prevail upon the newsletter editor to allow me to print some of them, in it for your inspection. (see pages 3 & 4)

The full set of graphics will be shown in my PD Catalog book. Sorry about those who use the 2 block graphics but unless somebody knows of a conversion program, you are out of luck. For those of you who have Commodore printers, I am certain that 3 block Print Shop Graphics can be converted to print master Graphics and used in that programme with your printer. Ask Ross Edwards or myself at the meeting.

I will have an original copy of 'Print Shop' (both 2 and 3 block Grapic Versions) at the meeting tonight. If you don't have the program and would like to try it out on your printer at home, ask to borrow it.

Another new addition to the DISK LIBRARY is the first decent Public Domain drawing program which I have seen. It is called 'PAINT X'. I haven't had an opportunity to fully investigate it yet, but if you don't have a drawing programme like Doodle, Koala Painter, ETC, It would be a good \$3 investment. How about some one doing a review of it for next months meeting?.

\*\*\*\*\*

### MAGAZINE LIBRARY RULES

There is no charge for borrowing magazines from the Club Magazine Library but borrowers must be paid up members for 1990. Check out the magazines held by the Librarian and number on the borrowing slip.

Because Library stock is extremely limited at this stage, only one magazine per family per month can be borrowed.

Loans are for a ONE month period and a \$1 fine will be imposed if the magazine is not returned at the next meeting. If you are unable to attend, please contact a Committee member to make alternative arrangements.

JEFF CAREY - C64 DISK & MAGAZINE LIBRARIAN

\*\*\*\*\*



## A THANK YOU

The Club wishes to thank Rod Gasson for his support to the library on his contributions of disks and computer magazines to add to the disk and magazine library. We will surely benefit from these, as we borrow them and get new ideas and information from them.



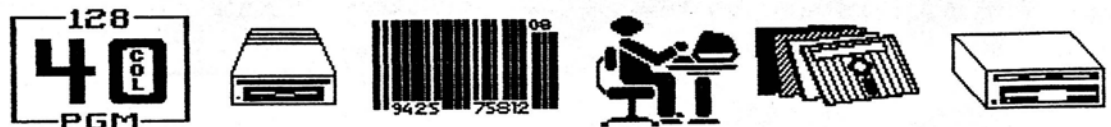

THIS DISK ALSO CONTAINS:  
PRINT SHOP BORDERS

PRINT SHOP FONTS

EASTERBASKET  
BALL 'N' BAT  
FANCY STRIPE  
SCROLL  
LOOP  
LOOP2

LRC LIQUID CRYSTAL  
FLINTSTONE  
GREEK  
STRIPES

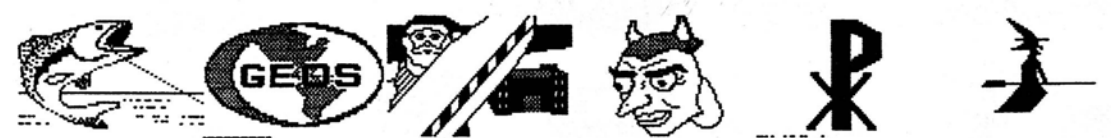
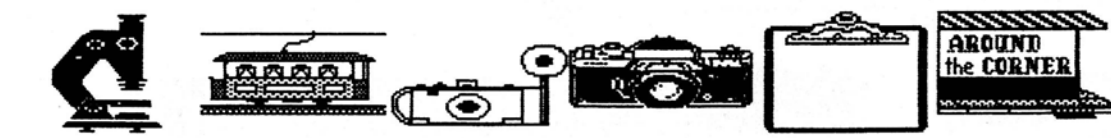

# 1570 Device Number Switch

A project I recently embarked on was to put a Device Switch into my 1570 disk drive. As I only had the circuit diagram for a 1541 disk drive, I did not realise the differences there was and the problems I would encounter, but with some research I overcame these problems. Before anything was to be done, some research was to be performed. The first thing to do was to find the pads for the device switching, as the instructions said. On the 1541 circuit board they are pads on the left of the circuit board, on the 1570 they are wire links on the right front of the circuit board. When I had found these pads or links, it was time to do some serious thinking and decisions had to be made, they were as follows :

1. Do I want Device No's 8 & 9 or 8,9,10 & 11 ?
2. Do I want the device switch to Reset the D.D. or to use a Manual Reset button?
3. Depending on the Switch or switches, where to put it or them?
4. Most important of all, am I game and confident enough to drill, file and solder around in my D.D., or should I allow someone else to do the job?

I chose to use the 4 device no's with manual Reset button which eliminates making up a small circuit for auto reset. I did a lot of accurate measuring and working out to place the switch and button on the Front/Right of the Disk Drive to make it easily accessible for me. Best of all, I was going to do the job myself because if I worked everything out myself the easy part was still to come.

I started out by purchasing a **DP4T** ( **Double Pole 4 Throw** ) slide switch, a Push Button printed circuit board mount momentary On switch and two **1N914** Diodes from Force Electronics for a total cost of about \$4.00.

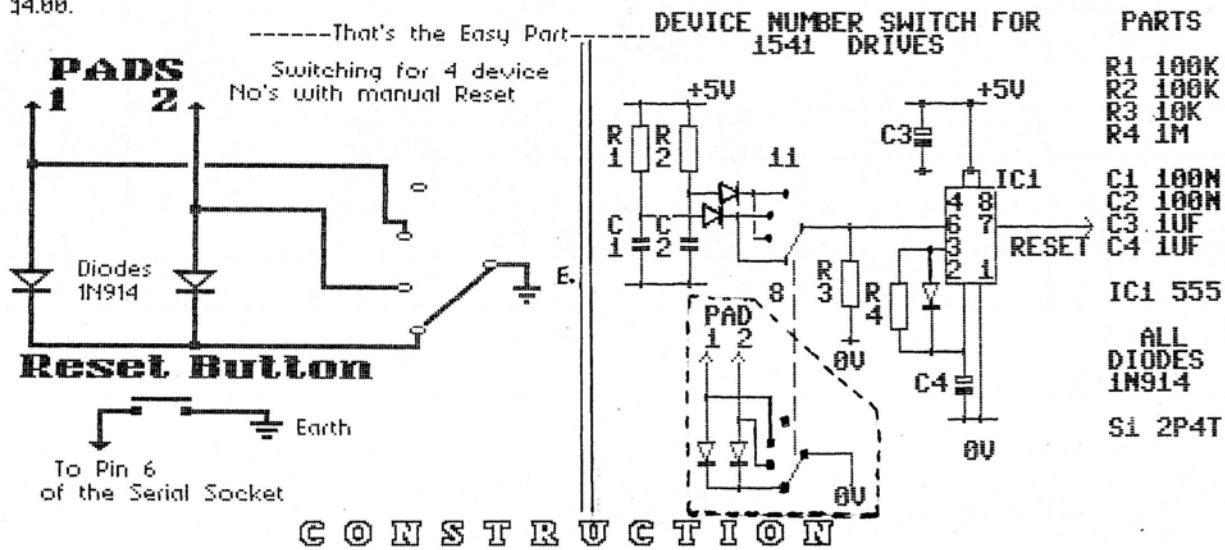

I started out by accurately drilling and filling the top half of the casing to fit the four position slide switch, making sure that I had enough room for the wiring as well as the switch. I then drilled a neat hole in the lower half of the casing for the Reset button.

The reset button was mounted on a piece of copper strip matrix board on which I also soldered the two wires before placing the button into place. With careful manoeuvring of the soldering iron I shaved and melted some of the side off the casings pillar, without doing so I could not get the switch into place. When I figured there was enough room I squeezed the button and board into place. I knew that I would not be able to get it out again, therefore the wires were soldered on earlier. Once it was in position I super glued it into position while I mixed up some Araldite to hold it more firmly in place.

The next step was to ignore the Reset Circuit side of the PAD switch and only concern myself with the Device side of the switch. I soldered up the diodes in the way shown and then soldered the wires to the switch. I then removed the wire links off the circuit board and checked with the aid of a multimeter, which two points were Earth and which points were for device switching. Once that was established I then connected four wires. . . . . Two for the device pads 1 & 2, One to the Earth side and another to the Earth for the Reset button. The other wire from the Reset button I connected to pin 6 of the Serial Socket where it meets the Circuit Board.

Before reassembling the D.D. I checked the circuit board and wiring over thoroughly and checked the joints with a magnifying glass, once I was happy with it I gave it a dry run. When I was happy with the testing I reassembled it and tested it thoroughly again.

There is a slight problem with the resetting and that is that when the button is pressed it will also reset the Printer or anything that is connected on the same Serial line.

The original circuit diagram was taken from an article in The Australian Commodore Review, an addition going back two or three years. The circuit diagrams supplied are a Graphic screen dump from a Commodore 128. The other was done with GEO Paint.

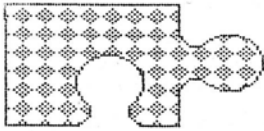

# COMPUTER PUZZLE

© ROSS WOODS & COMPANY

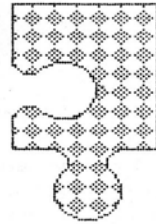

## COMPUTER WORDS A

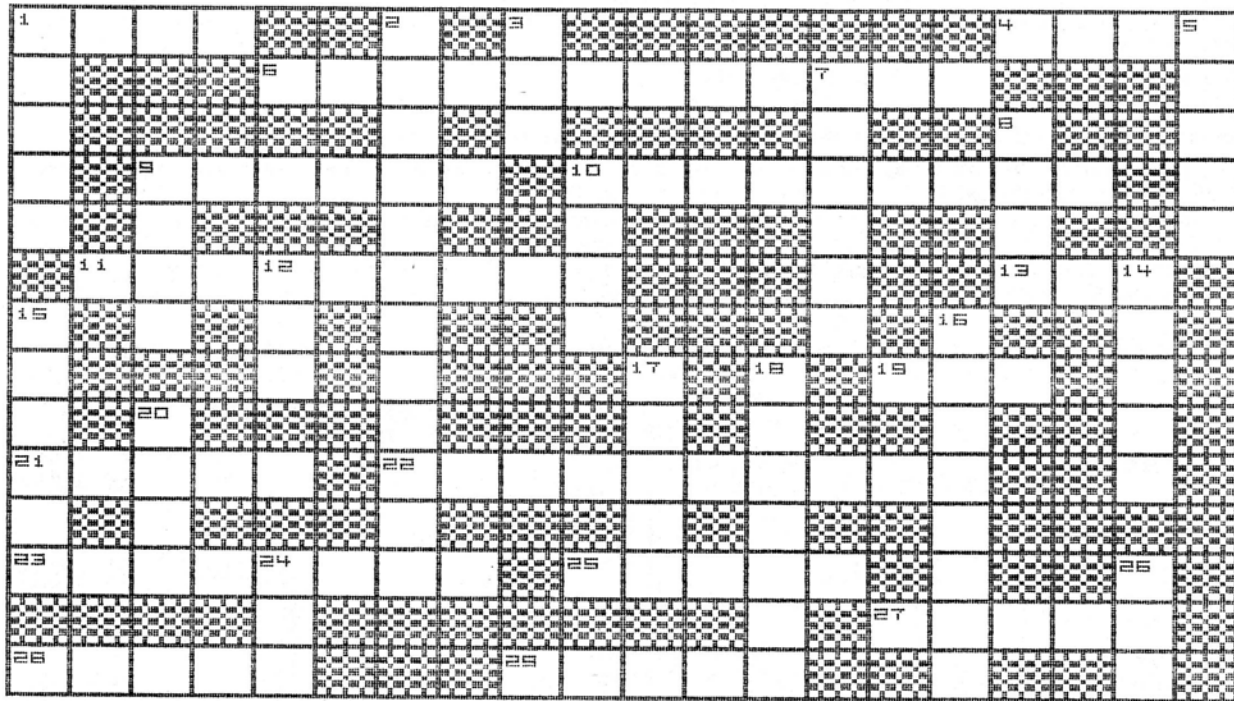

### ACROSS CLUES

1. written on screen
4. micro ----
6. program tools
9. pictures
10. printing program
11. brand name
13. word processor marker
19. to start program
21. disk -----
22. computer is
23. data program
25. computer's operators
27. not a joystick
28. display
29. phone link

### DOWN CLUES

1. fastload
2. numbers programs
3. printer has 9 or 24
5. commodore has four
7. send out
8. to load
9. geos file pictures
10. view memory location
12. use with mouse
14. language
15. program is-----when typed run
16. a use
17. contains eight bits
18. to instruct the computer
20. display program
24. binary digit
26. ---board

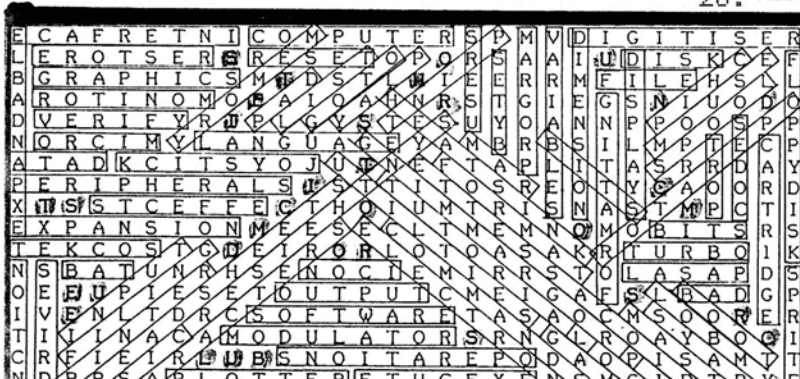

WORDSEARCH 1  
ANSWER

SOUTHERN DISTRICTS  
COMMODORE USERS CLUB INC.

# SOUTHERN DISTRICTS COMMODORE USERS CLUB INC.

DO YOU OWN OR USE A C64/128?  
IF YOU DO, ARE YOU INTERESTED IN  
IMPROVING YOUR SKILLS, SOLVING  
ANY PROBLEMS YOU ARE HAVING WITH YOUR  
C64/128.

OR JUST SOCIALIZING AND  
SWAPPING IDEAS WITH OTHER C64/128  
USERS. WHERE DOES THIS HAPPEN YOU  
ASK. AT THE MONTHLY MEETINGS (EVERY  
THIRD WEDNESDAY OF THE MONTH) AT THE  
SOUTHERN DISTRICTS COMMODORE USERS  
CLUB INC.

VISITORS ARE WELCOME, VISIT  
THE CLUB OR BECOME A MEMBER AND REAP  
THE BENEFITS OF A USERS GROUP.

FOR FURTHER INFORMATION: -  
CONTACT: -3820781

-----

# SOUTHERN DISTRICTS COMMODORE USERS CLUB INC.

DO YOU OWN OR USE A C64/128?  
IF YOU DO, ARE YOU INTERESTED IN  
IMPROVING YOUR SKILLS, SOLVING  
ANY PROBLEMS YOU ARE HAVING WITH YOUR  
C64/128.

OR JUST SOCIALIZING AND  
SWAPPING IDEAS WITH OTHER C64/128  
USERS. WHERE DOES THIS HAPPEN YOU  
ASK. AT THE MONTHLY MEETINGS (EVERY  
THIRD WEDNESDAY OF THE MONTH) AT THE  
SOUTHERN DISTRICTS COMMODORE USERS  
CLUB INC.

VISITORS ARE WELCOME, VISIT  
THE CLUB OR BECOME A MEMBER AND REAP  
THE BENEFITS OF A USERS GROUP.

FOR FURTHER INFORMATION: -  
CONTACT: -3820781

# NOTES FROM THE COMMITTEE

## A. G. M. ANNUAL GENERAL MEETING

The club's Annual General Meeting will be held on OCTOBER 17th 1990. At this meeting the present Committee will step down, and the positions will be declared vacant. So start thinking about your nominations, on who you think is the best person, for each Committee position. Positions will be President, Secretary, Treasurer, Editor as well as 64 Librarian and 128 Librarian, and assitant's.

If you can't make it you can still have your say, by handing in your written nominations. Write down the position and your nomination, sign the form and hand it to a committee member by 19th of september.

**SO HAVE YOUR SAY AND BE THERE.**

## CLUB COST

As prices goes up, things get harder. So now we haven't much choice to add a charge at the door. This Money will be for the covering of the tea, coffee and biscuit each. And Also covering the cost of the paper and copying of the DISPATCH DISK newsletter, that we are paying for now. We are asking \$1.00, to cover the cost.

## MEMBERSHIP FEES

With time catching up with us, it's time for the annual fees to be paid up, by OCT 17th or at the latest by the November meeting.

MEMBERSHIP FEES WILL BE AS FOLLOWS:-

JOINING FEE FOR NEW MEMBERS	\$5.00
MEMBERSHIP FEE (for the year)	\$10.00

All pervious members who have not renewed their membership are unfinancial and will have to rejoin the club and pay the joining fee again.

To be able to add items to the club's disk and magazine libraries, we need the money. So paid promptly. You have to the end of November to pay, if not, you will have to pay the joining fee again.

WRITTEN NOMINATION FORM  
FOR 1990-1991 COMMITTEE POSITIONS

Nomination \_\_\_\_\_

Position \_\_\_\_\_

Nominated by \_\_\_\_\_

WRITTEN NOMINATION FORM  
FOR 1990-1991 COMMITTEE POSITIONS

Nomination \_\_\_\_\_

Position \_\_\_\_\_

Nomination by \_\_\_\_\_



# DISPATCH DISK NOTES

## COMMITTEE 1989-90

President R. Cloosterman 382-0781  
Secretary M. Tippins 381-3181  
Treasurer A. Heard 085 56-5828  
Asst. Secretary A. Morrison 085 56-5013  
Newsletter ED. J. Van De Belt 382-8660  
64 Librarian J. Carey 294-8447  
128 Librarian M. Tippins 381-3181  
Our Disk and Magazine libraries are open at each general meeting from 7:30pm.

If you have any contributions for the newsletter, see Rob, Jeff or Jan.

## NEXT MEETING

Our next general meeting will be held on the 15TH AUGUST 1990 7:30pm.

## SUBJECT :- BASIC I

DEMO to be announced.

LOCATION :- Meetings are held in the house behind the Salvation Army Hall at 186 Elizabeth Rd. in Morphett Vale, just in from Beach Rd.

## MEETING RULES

- 1) NO SMOKING
- 2) NO DRINKING
- 3) NO SWEARING

Though the generosity of the Salvation Army, we are allowed to use the facilities in this house, in return for which we give them a relatively small donation. We ask for your co-operation in respect to the above.

While we cannot control what people do away from our club meetings, Piracy of copyright material cannot be condoned at our meetings.

## DISCLAIMER

The views expressed in this newsletter are those of the writers, and are not necessarily those of the club's committee or members.

The use of the word "COMMODORE" in no way implies any connection with any organisation bearing that name.

No part of "THE DISPATCH DISK" may be copied or reproduced in any way without the written permission of the committee and the author.

## WANTED

ASSISTANCE REQUIRED -THE CLUB STILL NEEDS THE ASSISTANCE OF SEVERAL MEMBERS IN THE FOLLOWING AREAS:-

- 1) Newsletter contributions
- 2) Expert Register. PLEASE help us to help others with their problems.

DEMONSTRATION TOPICS -If you have any requests for topics you would like to see demonstrated, speak up. Even, if it has already been done and you missed it, let us know. If there is reasonable interest, it can probably be repeated.

FUTURE MEETINGS -Help us to spread the word of our existence. Write out some small notices and place them where people will see them. Your local supermarket usually has a notice board as do some Newsagencies and Delis.

## FOR SALE

PUBLIC DOMAIN SOFTWARE - We have a large range of PUBLIC DOMAIN Software for sale through our library. Prices start at \$2.00 per disk which represents very good value. Catalogue disks are also available for only \$1.00. See Jeff at tonight's meeting for any enquires.

CHEAP DISK - How much do you pay for your blank disks?. The club is making bulk purchases of disks to help members save some money. The price of these disks is 70c per disk, which works out to be \$7 for a packet of 10. See Rob at tonight's meeting.

## MEMBERSHIP FEES

The scale of membership fees for this year will be as follows :-

Joining Fee for new members	\$5.00
Membership fee (to A.G.M)	\$5.00

All previous members who have not renewed their membership are unfinancial and will have to rejoin the club and pay the joining fee again, in order to add more items to the Club Disk and Magazine Libraries, We need the money so pay up promptly.