

COMPUTE.

The Journal for Progressive Computing™

A PREVIEW
OF
COMMODORE'S
DISK BASIC 4.0

CHUCK
STUART

ATARI'S STAR RAIDERS
DEFEND THE GALAXY. JORETTA KLEPPER

AND
Enhancing Commodore's
Word Pro II - LARRY ISAACS
Atari's 810 Disk System
- RON JEFFRIES & GLEN FISHER
Naming Apple Cassettes
Files - D.P. KEMP
The Single Board 6502
- ERIC REHNKE

Manual
Alphabet
Tutorial
on a PET
SUSAN SEMANCIK

GARY DEAN

softside software \$15.95 PET



ASSEMBLER 2001
 full featured mnemonic assembler-disassembler
 enter save load list run
 list the secret basic ROMs

softside software \$9.95 PET



DRIVING ACE
 ☆ ☆ 2 ACTION PACKED VIDEO GAMES ☆ ☆

PET BASIC BREAKTHROUGH

Softside Software presents

SYMBOLIC/STRUCTURED BASIC

At last, **Symbolic/Structured Basic** is available for your PET 8-32K personal computer! S-Basic is a pre-compiler that enhances the PET's built-in basic monitor with the addition of extra-control statements found only in the most sophisticated computers. **WHILE ... GOSUB ...** calls a subroutine as long as a condition is true. **UNTIL ... GOSUB ...** jumps to a subroutine unless the condition is true. The **IF ... Then ... ELSE** statement allows the programmer to command the computer to execute instructions if the normal IF condition is not met.

Forget about line numbers, S-Basic allows you to program naturally only naming (numerically or alphabetically!) statements that you will need to refer to, for ex-

ample: LOOP/PRINT "HI": GO TO LOOP. S-Basic program **lines can be up to 255 characters long**, two-and-one-half times as long as on standard Basic. S-Basic does not compromise any of PET Basic's existing features. All PET Basic commands can be used.

S-Basic includes an **editor** with full text capabilities, a **translator/pre-compiler** with its own error messages, and the **S-Basic loader**. These programs are recommended for disk-based PETs. A printer is optional but suggested. Cassette copies are available and require two cassette drives. Comprehensive instructions are included. Symbolic-/Structured Basic package is available complete for an **introductory price of \$35.95**.

- WHILE....GOTO....
- IF....THEN....ELSE
- 255 CHAR. LINES

A PET PROGRAMMING BREAKTHROUGH

- UNTIL....GOTO....
- SYMBOLIC OPTIONAL
- LINE NUMBERS

305 RIVERSIDE DRIVE, NEW YORK, NEW YORK 10025

INTRODUCING THE

AMAZING!

XYMEC HY-Q 1000™

THE WORLD'S MOST INTELLIGENT PRINTER.

With more features than any other machine—regardless of price—it turns mild-mannered personal computers into super-powered word processors.

- **FASTER THAN A SPEEDING PRINT BALL.**
Letter quality daisy print wheel lets you change type styles in seconds.
- **MORE POWERFUL THAN COSTLY SOFTWARE.**
5 built-in micro processors eliminate the need.
- **RIGHT JUSTIFIES.**
With 4 pitches plus proportional spacing.
- **ABLE TO TYPE IN REVERSE**
- **BOLD AS THEY COME.**
Types in **Bold** face, underlines, centers titles, sets columns... all automatically.
- **THE MASTER OF 6 LANGUAGES.**
English, Italian, Spanish, French, German and Portuguese.

It's the most amazing printer on this or any other planet.
Find out more at your computer store or call us from any phone booth.

CROMEMCO

APPLE

NORTH STAR

TRS-80

BALLY

TEXAS INSTRUMENTS

EXIDY

SWTPC

ALPHA MICRO

OHIO SCIENTIFIC

FAIRCHILD

HEATH

PET

ATARI

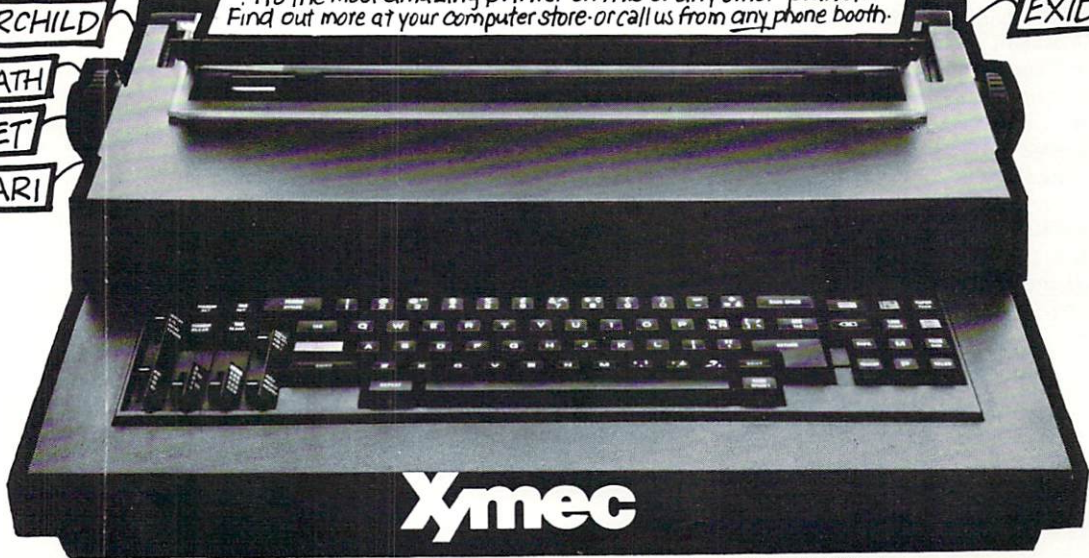

Xymec

17791 Sky Park Circle, Suite H, Irvine, Ca. (714) 557-8501

Available at the best computer dealers or direct from Xymec. Dealers inquiries invited.

©1980 XYMEC

Table of Contents

The Editor's Notes *Robert C. Lock*, 3
Computers and Society *David D. Thornburg and Betty J. Burr*, 7
Dr. Chip 8
Preview of Commodore's New Disk Basic 4.0 *Chuck Stuart*, 10
Enhancing Commodore's Word Pro II *Larry Isaacs*, 15
File Conversions on the Commodore 2040 Drive *Hal Wadleigh*, 18
Program listings for COMPUTE 20
Using the GET Statement on the PET *Alfred J. Bruery*, 23
Proper Diskette Handling *Chuck Stuart*, 24
Machine Language *Jim Butterfield*, 26
Review: Synertek Systems KTM-2 *Edward D. James*, 29
Utinsel: Enabling Utilities *Larry Isaacs*, 34
Identify Your Atari Colors *Len Lindsay*, 39
Manual Alphabet Tutorial on a PET *Susan Semancik*, 41
The Learning Lab *Marlene Pratto*, 51
Review: The Prestodigitizer *Laura M. Benson*, 56
A Micro for the Teacher *Thorwald Esbensen*, 58
Light Pen Selection on PET/CBM Screen *David R. Heise*, 60
The Consumer Computer *Len Lindsay*, 63
The Apple Gazette 68
Naming Apple Cassette Files *D.P. Kemp*, 68
On Apple II to Heathkit H-14 *Mike Wiplich*, 69
New Product Feature:
80 Columns and Upper/Lower Case Letters for
Apple II *Michael S. Tomczyk*, 70
Apple Software Note *Eric Rehnke*, 72
The Atari Gazette 74
Notes on Atari *Robert Lock*, 74
Star Raiders Defend the Galaxy *Joretta Klepfer*, 74
Star Raiders: The Wizard Behind the Game *Michael S. Tomczyk*, 75
Review: Atari Basketball Cartridge *Len Lindsay*, 76
Atari Program Saving *Len Lindsay*, 76
Review of Atari's 810 Disk System *Ron Jeffries and Glen Fisher*, 78
The PET Gazette 81
Oops! *W. M. Bunker*, 81
Null Return Revisited *Earl H. Wuchter*, 81
Cheep Print, PART 1 *C. A. McCarthy*, 82
Direct Screen Input *Len Lindsay*, 88
No CB2 Sound? *Larry Isaacs*, 88
A Versatile Serial Printer Interface for
the PET *Harvey B. Herman and Charles B. Pate*, 90
Rambling *Roy O'Brien*, 92
Review: MAE, A PET Disk-based Macro Assembler *James Strasma*, 93
Review: The PET Rabbit *James Strasma*, 94
PET Programs on Tape Exchange *Gene Beals*, 95
Memo to Machine Language Programmers *Jim Butterfield*, 96
The SBC Gazette 98
The Single Board 6502 *Eric Rehnke*, 99
More about compute II *Robert Lock*, 104
Nuts and Volts *Gene Zumchak*, 105
Read PET Tapes with your AIM *Mark Reardon and Eric Rehnke*, 110
Review: KIMEX-1 *Harvey Herman*, 113
Fast Tape Read/Write Programs for your OSI *Edward H. Carlson*, 115
Applications Review: Logic Analyzer for KIM *Roy Flacco*, 118
Try Pseudo Code *Eric Rehnke*, 120

Staff of COMPUTE:

Robert C. Lock, Editor/Publisher
Carol Holmquist Lock, Circulation Manager.
Larry Isaacs, Software/Hardware Lab.
Joretta Klepfer, Editorial Assistant.
Marlene Pratto, Educational Assistant.

COMPUTE. receives continuing assistance from the following persons:

Harvey B. Herman, University of North Carolina at Greensboro, Dept. of Chemistry. Editorial Assistance.
David Gibbs, The Design Group, Greensboro, N.C., Art Direction/Design Consultation.
Jim Butterfield, Toronto. Editorial Assistance.

The following writers contribute on a regular basis as Associate Editors:

Gene Beals, 115 E. Stump Road, Montgomeryville, Pennsylvania 18936.
Len Lindsay, 1929 Northport Drive #6, Madison, Wisconsin 53704.
Roy O'Brien, Post Office Box 426, Beaumont, California 92223.
Eric Rehnke, # 61, 540 S. Ranchview Circle, Anaheim Hills, California 92807.
COMPUTE. is published by Small System Services, Inc., 900-902 Spring Garden Street, Greensboro, North Carolina 27403. Telephone: (919) 272-4867.
PET is a trademark of Commodore Business Machines, Inc.
Apple is a trademark of Apple Computer Company.
Atari is a trademark of Atari, Inc.

Authors of manuscripts warrant that all materials submitted to COMPUTE. are original materials with full ownership rights resident in said authors. By submitting articles to COMPUTE. authors acknowledge that such materials, upon acceptance for publication, become the exclusive property of Small System Services, Inc. Unsolicited manuscripts not accepted for publication by COMPUTE. will be returned if author provides a self-addressed, stamped envelope. Program listings should be provided in printed form as well as machine readable form. Articles should be furnished as typed copy with double spacing. Each page of your article should bear the title of the article, date and name of the author.

Address all manuscripts and correspondence to COMPUTE. Post Office Box 5119, Greensboro, N.C. 27403. Materials (advertising art work, hardware, etc.) should be addressed to COMPUTE., 900 Spring Garden Street, Greensboro, N.C. 27403.
Entire contents copyright © 1979 by Small System Services, Inc. All rights reserved, "COMPUTE. The Journal for Progressive Computing" is a trademark of Small System Services, Inc. ISSN 0194-357X.

COMPUTE. assumes no liability for errors in articles or advertisements. Opinions expressed by authors are not necessarily those of COMPUTE.

ADVERTISERS INDEX

Aardvark Technical Services	117	IRIDIS	77
A B Computers	28	Kobetek Systems Ltd.	86
Abacus Software	97	Micro Computer Industries	17
Automated Simulations	49	Micro-Ed	50
CGRS Microtech	35,85	Micro Software Systems	38
CMS Software	14,87	Micro Technology Unltd.	11,33,IBC
Cognitive Products	21,56	Microphys	55
Commodore Business Machines	BC	NCE/Compumart	9
Competitive Software	61	NEECO	19,79
Computer Center of South Bend	114	Optimal Technology	34
Computer World	71	Optimized Data Systems	38
Computhink	22	P. S. Software House	91
Connecticut Microcomputer	30,31,37,48,49	Perry Peripherals	112
Creative Computing	67	Programma International	65
CURSORS	57	RAYGAM	40
Datec, Inc.	28	Rehnke Software	113
Digital Engineering	119	RNB Enterprises	100,101
Dr. Daley	25,39	Sawyer Software	21
DTI Office Products	13	Seawell Marketing	108,109
Eastern House Software	38,62,80,85,86	Skyles ELeCtric works	27,83,89
Electronic Specialists	48,120	Softside Publications	73
Falk-Baker Associates	106	Softside Software	IFC
Harry Briley	88	Sybox	5
Hudson Digital Electronics	103	TIS	56
Instant Software	44,45	3G Company	38
International Technical Systems	37,85	TNW Corporation	97
		Typewriters Unltd.	38
		United Software of America	66
		Xymec	1
		Zeigler Electronic Products	24

Subscription Information:
U.S. \$9.00/6 issue year
CANADA \$12.00/6 issue year (U.S. funds)
Europe: Air Subscription \$22.50 U.S./6 issue year
Other areas: Inquire for air rates.

In the United Kingdom and Europe, new subscribers and dealers should contact:

L.P. Enterprises 8-11 Cambridge House Cambridge Road Barking, Essex England IG1 1BNT (United Kingdom and Northern Europe)	Ing. W. Hofacker GMBH 8 Munchen 75 Postfach 437 West Germany (Germany, Switzerland, and Austria)
--	--

The Editor's Notes Robert Lock

COMPUTE GROWS ON

Introducing COMPUTE II

We're pleased to announce our second magazine, **COMPUTE II**. Our growth has been tremendous, and we're seeing pressure mounting for issue space. You Single Board Machine people are pushing for more room simply from the sheer volume of your submissions. And the Pet Gazette, and Atari Gazette, and Apple Gazette need to grow, not shrink. Our resolution? **COMPUTE II**, a new bimonthly magazine that will be staggered with **COMPUTE**. **COMPUTE** will stick to Pet, Atari, and Apple, and **COMPUTE II** will cover the Sym, Kim, Aim, OSI, and others.

COMPUTE will run approximately 88-96 pages, **COMPUTE II** approximately 64 pages during start up. The net effect is that each reader group gets more pages of magazine. Subscription prices will remain the same for either magazine: \$9.00 for six issues. A one-year subscription to both is \$15.00 until the end of April. After that it'll be \$18.00.

Sorting all of this out is no easy task, but here's our plan. If you are a subscriber who was a 6502 User Notes subscriber, you'll be switched to **COMPUTE II**. This will happen automatically. If you wish to continue receiving **COMPUTE** as well, you'll need to send us \$6.00 more before the end of April (preferably sooner). If you're a subscriber who indicated by card or letter what machine you have, and your machine is Aim, Kim, Sym, or OSI, you'll switch to **COMPUTE II**.

If you did not indicate what your machine was, please send us a letter. When you did not indicate a machine, we will assume you remain with **COMPUTE**. I realize this is terribly inconvenient, but it's better to do it now before we get any bigger.

COMPUTE II will follow the same general format as **COMPUTE**. Both publications will continue to be 6502 resource magazines. Issue #1 of **COMPUTE II** will be cover dated April/May, 1980. We hope you'll enjoy it. And you **COMPUTE** readers can expect to continue to enjoy even more information in **COMPUTE**.

One last note... I'm sure someone will get slighted during this changeover. Please bear with us. If you end up with the wrong magazine, drop us a note, and we'll take care of it.

All of you West Coast readers should plan to stop by and visit us at the Fifth West Coast Computer Faire. The show, at the Civic Center in San Francisco, runs March 14, 15, and 16. Friday-Saturday Hours are 9:00-6:00; Sunday, 1:00-6:00.

Three new columns debut in this issue of **COMPUTE**. They're a mix, balancing out some areas that we hope will add to the general usefulness and enjoyment of **COMPUTE**:

Computers and Society

David Thornburg and Betty Burr will be addressing topics of concern and interest to us all. See Column #1 for full details.

Machine Language

Catchy title, right! Well it certainly tells you what the column's about. Written by Jim Butterfield, Machine Language will be of interest to all programmers, whether you're brand new or an old hand. **COMPUTE** is excited about being the first major magazine ever to have a column from Jim.

Nuts and Volts

Gene Zumchak will be offering help and advice on the vagaries of the 6502 and its family of support chips. If you're interested in the whys and wherefores of your hardware, this is a good place to start. Gene, currently writing a book for the Blacksburg group, is a well known and respected lecturer and author in our field. We're pleased to welcome him to **COMPUTE**.

The Consumer Electronics Show Las Vegas, Nevada January 4,5, and 6

It was a very interesting show. See Chuck Stuart's article previewing Commodore's Basic 4.0, the Dr. Chip Column, and our comments in the Atari Gazette for more details. There were very few exhibitors with a personal/ small business computer orientation, but those who chose to appear did so in a big way...

Commodore had an impressive booth, very professional in design and layout. We were pleased to see them carrying through on their new attention to dealers and end users. I was personally very impressed with the new product introductions. The 80 column CBM,1.2 meg disk drive,and IEEE acoustic coupler.It's high time, and needed. (Source and Telenet, here we come!) **COMPUTE** tried very hard to get a coupler in time for review this issue. We'll include it next time. It's good to see Commodore making the marketing moves necessary to remain among the industry

leaders. They'll be showing up at more of the trade shows, and are scheduling a major national advertising campaign. I've been informed (via "channels") that the time of disproportionate attention to the foreign markets is over, and 1980 is the year of the U.S. As the product line stabilizes with the "high end" expansions, we can get down to business.

Atari had a super display, presenting their home video games and entire personal computer line. We saw both printers, the disk drives (see the 810 Disk Drive review in the Atari Gazette), and much of the software. It was literally impossible to get to the machines because of the heated games going on. The software was impressive. The Atari reps were there in full force, from all areas of the country, a good plan because new dealers were able to make contact on the spot with someone from their "home" region. All is not roses with Atari however. As of this writing, many East Coast dealers have yet to receive machine #1, while West Coast dealers are shipping from stock. Shades of other system introductions in the past, right? Although this problem is currently being resolved, and should be cleared shortly, the software fell a bit behind and is just now being shipped. Oops! We talked to one dealer sitting on a large hardware inventory with no software. He was just a bit angry. And so it goes. I'm beginning to think that these problems will occur in spite of the history of similar problems in the industry. Everybody must learn something from the problems of the last manufacturer, but best intentions aside, it's difficult to pull off a totally clean product introduction. Especially on the scale of the Atari systems with everything happening at once. One more aside: We had some heated debates several months ago about the market differences between Commodore and Atari. One West Coast "Pet-Product" marketer argued that Atari would leave no holes for entrepreneurs (other than software support), unlike Commodore who have spawned several generations of supporting industries. From here, for now, I'll disagree. I expect to see ROM cartridge software from outside vendors at very competitive prices, memory expansion, and more, developing in the next few months. The manufacturers among you will show us over time, I'm sure.

Apple had a large booth, and every machine had the new Summagraphics licensed graphics pad hooked up and running. There is one observation I'll throw out. It's not directed at Apple per se, but more of a general comment on the state of the industry. We're a young industry, still growing up in many ways. Many of the "personal" computer companies who've made it through the initial shake-outs are moving to the small business markets with at least a part of their product line. What we're seeing in the industry is a move to pull in the sophisticated marketing skills so often lacking in the management teams that start the companies. A balance between the technicians

who know a great deal about the machines and the software, and the salespeople who know more about selling. That mix is still evolving, and was really brought home to me in the Apple booth when I overheard a well-dressed businessman tell a young Apple booth worker he wanted to talk to someone about becoming an apple distributor in a large midwestern state. The conversation continued:

A: "You'll need to talk to Mr. X. Call him in California after Wednesday."

D: "Can't I talk to someone here?"

A: "He's not here right now."

D: "You mean Mr. X is at the show?"

A: "Yes but he's not here right now."

D: "Well, I'll be here today and tomorrow. Can I talk to him later?"

A: "He's at lunch and I don't know when he'll be back."

A: Takes piece of paper and writes Mr. X's name on it, hands to dealer. It's a phone number of California office.

A: "You can try tomorrow, he should be around."

D: "Isn't there anyone else I can talk to?"

A: "No."

So it went. A businessman trying to conduct business (that's what the show's all about) and dealing with a very helpful but ineffective programmer.

Other Notes

Software Packages

There's an interesting move afoot on the part of some of the software vendors. Two I'm aware of are Dr. Daley, and Competitive Software. Both offer, for varying prices, software packages made up of collections of software. I've seen them and think it's a timely move. For new machine owners, interested in building a ready-made collection of software, they're a good value. Both come in attractive vinyl binders with full documentation and other helpful comments.

Business Software Review

We're starting our structured review of business software packages. Our goal is to present information on the breadth and capability of the packages, with additional comments on documentation, user and dealer support and so on. It would be extremely helpful if you readers could help in the following ways:

1. If you're currently using a software package, send me your comments, however brief, on whatever aspects of the package you care to comment on.
2. If you're still looking, send me some comments on what you're looking for. Include thoughts on the whole process, dealer support, software house support, style and structure of the program, etc.

YOU WIN!

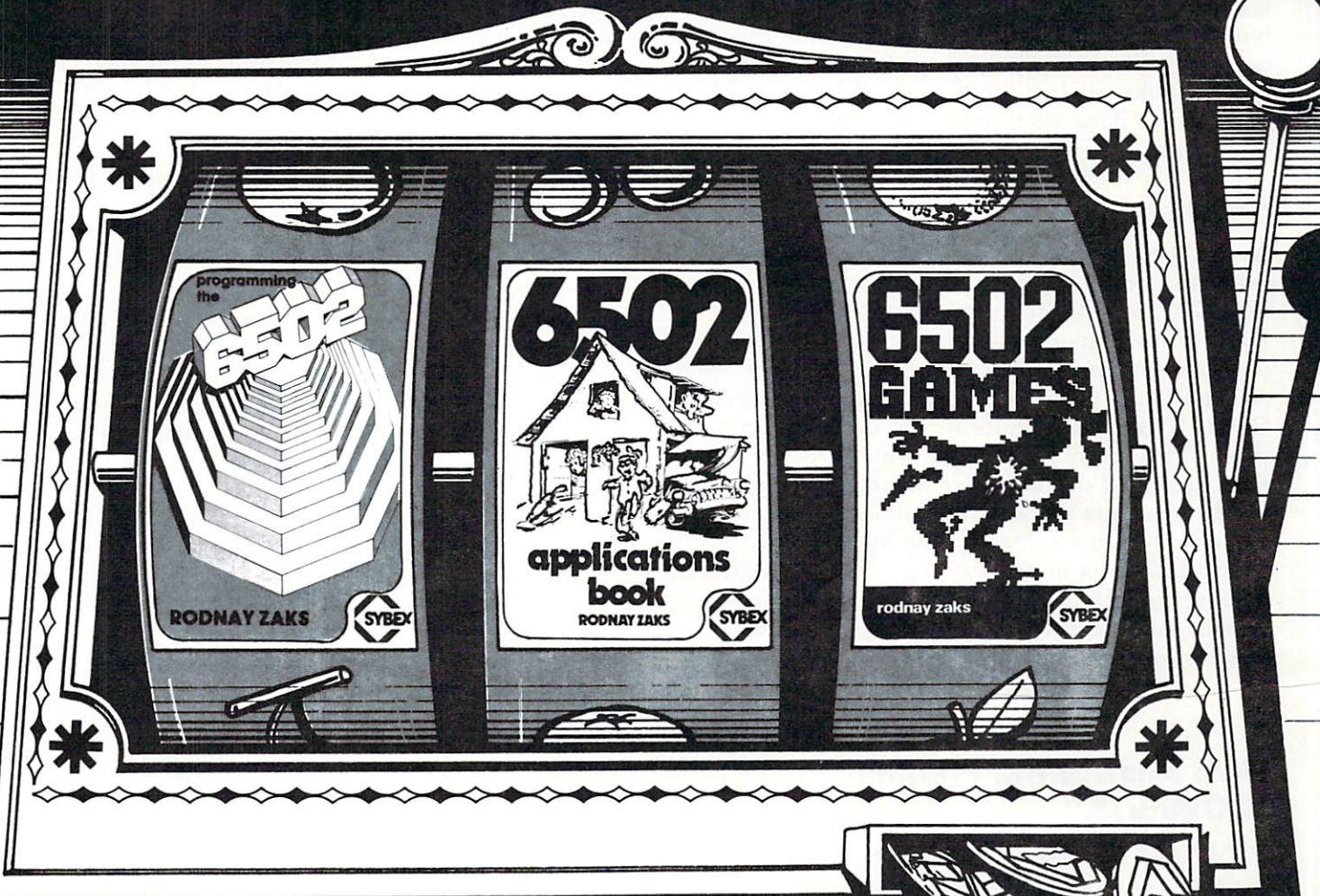

with SYBEX

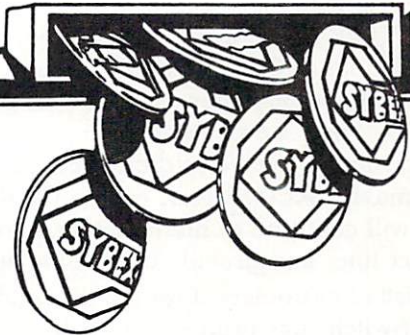

PROGRAMMING THE 6502

This book is designed as a progressive, step-by-step approach to assembly language programming—with exercises developed to test the reader at every step. Learn to write complete applications programs. Features: Programming and addressing techniques, input/output techniques and devices, application examples, data structures, program development and more.

Ref. C202

\$12.95

6502 APPLICATIONS BOOK

This title presents real life application techniques for any 6502 based micro-computer board. Programs presented cover building a complete home alarm system, electronic piano, motor speed regulator... and more. Learn techniques ranging from simulated traffic control to analog-digital conversion. The KIM-1, SYM-1 and AIM 65 are thoroughly covered.

Ref. D 302

\$12.95

6502 GAMES

Designed as an educational text on advanced programming techniques, this book presents a comprehensive set of algorithms and programming techniques for common computer games. All of the programs were developed for the 6502 at the assembly language level. Learn how to devise strategies suitable for the solution of complex problems commonly found in games.

Ref. G402

\$12.95

Please send me _____ Charge my _____ Visa _____ Mastercharge
 Name _____ American Express
 Company _____ Card # _____ Exp. Date _____
 Address _____ Signature _____
 City _____ State _____ Zip _____ Please send me your detailed catalog.

TO ORDER:

By Phone: (415) 848-8233, Visa, MC, AmEx
By Mail: Indicate quantity desired. Pre-payment required

Shipping: Add \$1.50 per book (UPS) or 75¢ (4th Class - allow 4 weeks delivery)

Tax: In California please add tax

AVAILABLE AT BOOK AND COMPUTER STORES EVERYWHERE



**2344 Sixth St.
 Berkeley, CA
 94710**

Our goal with this series is several-fold. We want to present an overview of what's currently available, from where, and at what price. We plan to cover features, support, and so on. The goal of the series is not to crucify any particular software packages, but the series will help make you a more informed consumer. We also want to provide as much information to the vendors about your needs as possible. So crank up those word processors and send me your comments.

COMPUTE-Pons(?)

As you'll see, we've dropped our direct mail response cards. They were bulky, heavy, and expensive. This issue, we're introducing "COMPUTE-Pons", little coupons you can tear out, stick in an envelope and return to an advertiser. Use them. Most people will not cut a coupon out of an ad, especially COMPUTE readers, since we use our magazines so much. That's why we came up with COMPUTE-Pons. They tell the advertiser where you found them, and help you get the same kind of fast feedback from the advertiser that you give them by using the COMPUTE-Pon in the first place. They're designed to be removed from the magazine for just that reason. Enjoy them. I'll be interested in seeing how it turns out.

We'll Answer the Phones "COMPUTE."

COMPUTE wants to remain a major resource magazine for 6502 owners. To support that effort, we've made some major changes here at Small System Services. First, we've decided to get out of the hardware business. We've sold our new product family, Spacemaker, ROMdriver, etc. to CGRS Microtech. They will continue to manufacture and market the product line, and provide continuing support to our established customers. Our "old" product line, The Basic Switch, has been sold to P.S. Software House (formerly Petshack). They will provide continuing support for established customers as well as new ones.

A big decision, and a major change. I want to take the space here to explain. We're a small company, and COMPUTE is very important to us. We've made the decision that that's where our time and energy will go. We want to build COMPUTE and COMPUTE II. A happy expansion of all of this is that we're determined to maintain our resourcefulness as a magazine. If we're not designing and manufacturing products, we can put all of that energy into the pages of your magazines. The first extension of that is the article in this issue on enhancing Commodore's Word Pro II.

There's a second major reason for our decision. As I've already indicated, and I presume you can tell from the magazine, we're committed to being a major resource. Frankly, having a hardware line and an unbiased, objective magazine are somewhat inconsistent. To date, we've bent over backwards to avoid any problems, even to the extent of cutting our own advertising in Issue #2 when we ran out of space. Still, there have been some problems, and as Editor and Publisher, I have to be able to make the daily decisions I have to make with you readers in mind. Our sale of our new product line, and decision to pull out of the hardware field, gives a clean slate. And a lot more time for COMPUTE and COMPUTE II.

So that, in a few paragraphs, represents a great deal of change for us. As COMPUTE has grown, so have we. We're excited and happy about the future.

Back to the basics. We want to grow more than ever. COMPUTE has literally been taking off, and we want your support in continuing that. Help us get our publishing feet firmly on the ground by reading and acting on the offer on page 97. We plan to be around for a long time!

Regarding circulation:

What a headache! All of you Pet User Notes people were overjoyed when you found out from our letter that COMPUTE was coming. And then it didn't come, and didn't come, and finally showed up two or three weeks after I said it should. I felt an explanation was in order: When we sent the letters in December, telling you of the change, we discovered one of the side benefits of a first class letter. Automatic forwarding, etc. It had been months since an issue of Pet User Notes had been mailed, and guess what? You'd been moving and moving. Within a week or so after our mailing, your letters started coming back with "I've moved to...". Well, the magazines go out third class mail which means they get thrown away if you've moved. So we waited. We ended up with almost a 10% change in the Pet User Notes list we started out with. That cost us a few weeks, but seemed worth it. Then we stuffed all of your double issue magazines in envelopes, appropriately sorted by zip, and delivered you to the post office. Guess what? The weight limit on third class bulk mail is 22 ounces, and your envelopes weighed 24 ounces. This kicked you over into fourth class mail. Fine, but fourth class mail is zoned. We had to go back and figure out which bags of magazines were going to which zones, and so on. Finally they went out. My apologies to those of you who called or wrote during the interim. I hope your COMPUTEs have reached you and that you'll decide to stick with us. We really aren't that unreliable!

Computers and Society

David D. Thornburg and Betty J. Burr
 Innovision
 P.O. Box 1317, Los Altos, CA 94022
 Electronic mail: Source, TCE132

This is the first column of a series on the role of the computer in society. Rather than dictate the scope and direction of this column, we thought that it might be a good idea to suggest topics that could be covered, and invite your help in making this column responsive to your ideas and concerns. We ask you to write to us, just as we will write to you.

The reason for writing this column is fairly easy to figure out. As even the most enthusiastic personal computer user realizes, computers seem to be getting a lot of bad press in the newspapers lately. Most likely you just shrug many of these stories off as yet another example of sensationalism. After all, having a computer system work properly isn't nearly as newsworthy as having a system that sends an incorrect bill for \$1,000,000 because of a programming error.

Stories of this sort have a different effect on many people who see this type of "computer error" as a sign of technology run amok. Well, lets face it, computers can be used to do some pretty cruddy things but, as most of you know, they can be used for tremendously good purposes as well. Society is not well served by a public divided into two extreme camps (witness the idiocy displayed by both extremes on the Three Mile Island issue). The real challenge then, is for everyone to become sufficiently computer literate so that the implications of this technology can be clearly understood as computers are applied to ever more novel areas. We can (and should) help to shape the future, rather than sit around and let it be shaped for us.

And that brings us back to the function of this column. We want to hear from you! This is to be your column - a place where you can share insights, gripes, anecdotes - a place to carry on spirited discussions. This column can also be a place to announce pending legislation involving data bank privacy, interconnection of large data bases, computer security, etc.

We also want to hear from those friends of yours who may not know a whole lot about computers, but who care a whole lot about society. Give them copies of this column and encourage them to write to us.

What should the column cover? Here are a few topics that have crossed our minds.

What are the implications of electronic mail? If the U.S. Postal Service uses it, will they ask Congress to reduce the speed of light? Some of you must be using The Source, or other electronic mail system. Tell us what you like, or don't like, about sending mail this way.

A good perennial question is "Can Machines Think?" Should we let robots into the home? Into country clubs?

What about the "paperless" (OK, "paper-lean") office of the future? Should service workers operate out of their homes and save gas? What effects will this have on family life, contact with work associates, etc.? What is the future for the computer in the art world? Will digitizer tablets supplement brushes and canvas?

What do others say? Lots of books on the computer's impact on our lives are being published. Would you like to read (or write!) reviews?

Will computers "relegate the skills of reading and writing to 'pleasure' uses," as one science reporter wrote?

How should computers be used in the schools?

What are the most unusual uses of computers you can think of?

As you see, we can do a lot in this column; but, before we rush to the mail box to pick up your letters, we want to ask you one more favor. We don't want this column to turn into a somber doomsday piece, even when we write about topics of serious concern. Help us keep our balance. If you have a funny (but true) anecdote concerning computers that you would like to share, pass it along.

The new uses for computers in society can be determined by all of us if we care enough to work at understanding both the promise and the problem of this technology. Let us all work together to make this happen.

Thanks.

Commodore's New Product Timetable *Robert Lock*

1. **Basic 4.0**, as described in Chuck Stuart's article, is scheduled for introduction in April of this year. 4.0 will be introduced as the standard firmware on the new 80 column machine. I'll present a full review of the 80 column system in Issue #4.

2. Basic 4.0, a five ROM set, will be available as an **optional upgrade** to 16/32K machine owners and purchasers for \$100.00.

3. **DOS 2.0**, originally scheduled for introduction with Basic 4.0, is undergoing an extensive pre-release rewrite, and isn't expected to be introduced until June or July.

4. The rumored "**Business Basic**", with decimal arithmetic and 16-18 digits of accuracy is in the works, but still some months away.

5. See Chuck Stuart's article and Dr. Chip's Column for more detail.

Dr. Chip

It looks like Commodore's line of PET and CBM computers will reach a stable plateau soon. A couple of new styles of machine are coming, but they won't be radically different from the computers we know now. Users can look forward to perhaps a couple of years; no shocking new changes are in the works to make today's machines obsolete.

New ROMs are coming...in a new 80 character machine. Before getting into details, let's look at the impact of the new machine on present owners. First, it is possible to upgrade an existing 16K or 32K by fitting the newer ROM when it becomes available. The new ROMs take up more memory space. That means that owners of original model PETs can't go there; their machines don't have sockets enough to fit the new system in.

The new Basic ROM currently goes by the name BASIC 4.0; It has two main features: very fast garbage collection, and a built in disk interface which makes it easy for unskilled users to deal with disk.

For those lucky users who have never encountered garbage collection, it might be useful to briefly describe this peculiar term. If lots of strings are being used in a program, they need to be re-packed into memory every once in a while; this job is called 'garbage collection'. On existing PET/CBM products, it can take a great deal of time to do this. On BASIC 4.0, it's done in a fraction of a second. There's a small penalty to be paid for this speed: every dynamic string occupies two extra bytes of memory.

The built-in disk interface is something like the existing DOS program popularly called 'the wedge'. The commands are in English, however, so that you can say 'CATALOG' to get the directory from both disks. Some of the commands seem backwards: for example, you now say COPY "DOG" TO

"CAT" instead of C0: CAT = 0:DOG, but it makes sense in English so that confusion is not likely.

The PET seemed to get more complicated when disk arrived. With BASIC 4.0, it's back to simple operation once again. Turn the unit on, and press SHIFT and RUN/STOP and you'll load the first program from drive 0 of the disk. Easy? Sure: and so is asking about disk errors. Just say PRINT DS\$ and you'll get the whole story. Variables DS and DS\$ are now special names (like ST and TI and TI\$); whenever you use them they get the current disk status for you.

Some of the commands in the new PET system are intended to be used with the new disk features of disk ROM 2.0. You don't really need the new disk ROM, but it looks like the two systems were built to fit together. For example, BASIC 4.0 doesn't give you an INITIALIZE command, apparently because you won't need it with the new disk ROM.

The new disk commands are more powerful than the old "wedge" commands in one significant way: they may be used in a program. One of the upward-compatibility problems we will have to watch for is programs containing keywords such as DOPEN, SCRATCH, or APPEND. They won't work on existing machines - and, for that matter, APPEND won't work until the new disk ROM is fitted.

BASIC 4.0 may be fitted to existing 16K and 32K machines. It takes up an extra socket - the system now starts at hexadecimal address B000 instead of C000 - which makes it an 18K system rather than the former 14K. It won't be possible, of course, for original-PET owners to plug 18K worth of ROM into 14K worth of sockets.

The jumbo machine has an eighty character screen which is somewhat larger than on the old PETs. This changes the appearance noticeably - the machine doesn't look as 'tapered' as before - but looks quite pleasant.

The 80-character screen still has 25 lines. The characters look smaller but not crowded. To keep everything in balance, the lines are further apart. This creates a problem with graphics, since the graphic characters no longer touch above and below... there is a POKE command which makes the characters taller so that graphics will touch, but then the regular alphanumeric characters look rather tall and skinny.

The advantages of the eighty character line are obvious. Now you can put those financial reports up on the screen; now, your Basic programs read better, and can be modified more easily.

So the picture looks good. There are changes coming up; but they're not radical, so that existing users can keep in touch. Retrofitting will be available in many cases for those who wish to upgrade. And the existing systems will still be compatible - programs, tapes and general organization will be the same.

10-DAY FREE TRIAL

Send for our
FREE Catalog



\$100 FREE ACCESSORIES WITH 16K OR 32K PET

When you buy a 16K or 32K PET, apply \$100 toward PET accessories, FREE! Just indicate on your order that you have reduced the cost of your accessories by \$100.

FREE
SAVE
\$98

Terminal Package with 8K PETS

See Special Below

PET ACCESSORIES

8K-Keyboard N.....	\$795
16K-Keyboard B.....	\$995
16K-Keyboard N.....	\$995
32K-Keyboard B.....	\$1,295
32K-Keyboard N.....	\$1,295

B—large keyboard (graphics not on keys)
N—large keyboard with graphics symbols

SANYO MONITORS

SALE!

9-inch
\$169



SALE!

15-inch
\$279

Perfect for PET & APPLE Owners...
Sanyo cassette recorder..... \$55

apple II plus

\$200 FREE ACCESSORIES

The new Apple II with Applesoft BASIC built-in! Eliminates the need for a \$200 Firmware Card and includes new Autostart ROM for easy operation. This combined with the FREE accessories from NCE could save you up to \$400 on a 48K Apple II system!

16K Apple II Plus—\$1195 (take \$100 in free accessories)
32K Apple II Plus—\$1345 (take \$150 in free accessories)
48K Apple II Plus—\$1495 (take \$200 in free accessories)

Apple II Accessories	
General Business.....	\$625
PASCAL.....	\$495
Integer BASIC ROM Card.....	\$200
VISI-Calc.....	\$99
Centronics Printer Interface.....	\$225
Disk and Controller.....	\$595
Parallel Printer Card.....	\$180
Communications Card.....	\$225
Hi-Speed Serial Card.....	\$195
Firmware Card.....	\$200

Hazeltine

Super Terminal Sale!

1410 Reg. \$900 1500 Reg. \$1,069
SALE! \$749 **SALE! \$995**

PAPER TIGER 440SPE

The Graphics Printer for Apple II

Now you can print illustrations, block letters, charts, graphs, and more—all under software control. And with the expanded buffer, the Paper Tiger can hold the text from an entire 24-line-by-80-column CRT screen.

\$1194.00 440 Reg. w/o graphics: \$995

REMOTE TERMINAL

for only \$98

A self-contained module and program cassette enables your PET to function as a 300 baud terminal. Supports Upper/Lower case, Rubout, Escape and all control functions. Output is TTL. Can be used with THE SOURCE. You will need the Terminal Option, Cat Coupler & EIA Cable to do this. Complete package which includes all 3 avail. from CompuMart for \$279.

FREE WITH PET PURCHASE



CAT COUPLER

New 300 baud Originate/Answer Acoustic Coupler Looks good, works great

SALE \$179

Excellent Performance—Looks Great

The TNW-2000

Bi-Directional RS-232 Serial Interface

Interface your PET to printers, modems, CRT terminals, plotters, paper tape readers and punches—or other computers. The TNW-2000 Serial Interface lets you connect your PET to RS-232 serial devices. Comes assembled and tested with cable to connect unit to an IEEE Standard or Commodore PET connector.
TNW Bi-Dir. RS-232 printer X-face..... \$229

HEATH

The All-In-One Computer

Dual Z-80 Processors • Built-in 102K Floppy Disk • 16K to 48K RAM • 25 x 80 Character Display • Upper/Lower Case and Line Graphics • 80 Character Keyboard with Keypad • 8 User-definable Keys • Two BASIC's and Auto-Script Word Processing available • Can support CP/M

WH89 with 16K RAM.....	\$2,295
WH89 with 32K RAM.....	\$2,445
WH89 with 48K RAM.....	\$2,595
WH17 Second Disk Drive.....	\$550
Dual-port Serial Interface.....	\$85
HDOS Operating System.....	\$100
Microsoft BASIC.....	\$100
Word Processing.....	\$395



Lear Siegler's ADM-3A

The ADM-3A is industry's favorite dumb terminal for some very smart reasons:

- 12 in. diagonal screen
- Full or half duplex operation at 11 selectable data rates
- 1920 easy-to-read characters in 24 rows of 80 letters
- Typewriter-style keyboard
- RS-232 C interface extension port
- Direct cursor addressing

Our Low Sale Price \$795

CompuMart has the following Lear Siegler products in-stock. Call for complete specs, options, & special OEM prices:

ADM-31 • High resolution • Full editing capabilities • 90 key keyboard. • All 128 ASCII characters.

ADM-31 SALE! \$1,195 Reg. Price \$1,450

ADM-42. The low-cost, semi-intelligent video display terminal that provides total flexibility of format, editing, interface & transmission. 2 pg. display expandable to 8. Detachable keyboard.

ADM-42 SALE! \$1,595 Reg. Price \$1,795

310 Ballistic Printer. Long-Life, Exceptional Quality.
SALE! \$1,195 Reg. Price \$2,045

ZENITH COLOR VIDEO MONITOR

Zenith's first color video display designed specifically for computers.

This 13-inch monitor is Zenith's first color video display designed specifically for computers. Features include automatic color level, color processing and degaussing circuits.

Zenith Color Monitor \$499.00

WE'VE GOT IT!

A Calculator, A System, A Whole New Standard.

HEWLETT-PACKARD'S HP-41C.

130 built-in functions • Alpha capability • 400 lines expandable up to 2,000 of program memory • Continuous memory • RPN logic.

"Customize it. Reassign any program or standard function to any keyboard location you want.
Enhanced programmability. Up to 6 levels of subroutines; 10 conditionals, 56 internal flags, specific loop control, indirect addressing, local & global branching. **HP-41C Calc. \$288**

THE SYSTEM.

Memory Modules. Increase capacity to 319 registers or 2,000 lines. **\$45.**

"Extra smart" Card Reader. Records programs & data onto blank mag-cards. **\$180.**

The Printer. Portable, quiet, thermal operation. Upper & lower case; plotting routines. **\$320.**

Application Modules (\$45 ea.) Standard Pac ROM, Statistics ROM, Math ROM, Financial Decisions ROM, Surveying ROM.

NCE/CompuMart has the following quality Hewlett-Packard scientific and business calculators in stock. Call for complete product info and specs:

HP-31E-Scientific, \$49.95 • HP-32E-Advanced scientific, \$66.95 • HP-33E-Programmable scientific, \$79.95 • HP-37E-Business management, \$69.95 • HP-38E-Advanced financial, \$108

CONTINUOUS MEMORY CALCULATORS
HP-33C-\$114.95, HP-34C-\$144.95, HP-38C-\$144.95

NCE/CompuMart SINCE 1971

DEPT BY30, 270 THIRD ST.,
CAMBRIDGE, MA 02142

To Order: **1 (800) 343-5504**

In Mass.: **1 (617) 491-2700**



Member:
Computer Dealers
Association

IMPORTANT ORDERING INFORMATION

All orders must include 4% shipping and handling. Mass. residents add 5% sales tax; Mich. residents 4%, for sales tax.

Phones open from 8:30 a.m. to 5:30 p.m. EST Mon.-Fri. • P.O.'s accepted from D&B rated companies — shipment contingent upon receipt of signed purchase order • Sorry no C.O.D.'s • All prices are subject to change without notice • Most items in stock for immediate shipment — call for delivery quotation • In the Ann Arbor area? Our retail store is open 11:00 a.m. to 7:00 p.m. Tues.-Fri., 10:00 a.m. to 5:00 p.m. Saturdays (closed Sun. and Mon.)

If not satisfied, return your purchase within 10 days for full refund of purchase price!

A Very Last Minute Editor's Note: I'm impressed! Our CBM Model 8032 (32K, 80 Columns by 24 lines) just arrived. Here's a two minute overview:

1. Same size keyboard, slightly less staircased than it's equivalent on the Commodore Business Machine.
2. Screen resolution is very good...
3. Whole new board layout: one cassette exits through the memory expansion port slot; the other exits normally at the rear.
4. Demo program indicates ability to define windows (e.g. partial screens), etc. A full review next time. RCL

A PREVIEW OF COMMODORE'S NEW DISK BASIC 4.0

Chuck Stuart, President
CMS Software Systems

5115 Menefee Drive Dallas, TX 75227

Commodore's new DISK BASIC has finally been announced and should be available from your local Commodore dealer by the time you receive this magazine. DISK BASIC is a combination of BASIC 4.0, which replaces the present BASIC, and DOS 2.0, which replaces the present DOS 1.2.

Besides supporting fourteen new disk commands, BASIC 4.0 has corrected the following known bugs in the previous version:

- 1) IEEE devices which returned a Status of 1 to an INPUT statement caused the interpreter to hang up.
- 2) The 41st and 81st GET on a line returned garbage. The 256th GET returned the first character of the same line.
- 3) While key entering on the last line of the screen (in response to an INPUT statement), the Auto Scroll process appended the INPUT statement prompt message to the data read.
- 4) The 64 millisecond IEEE time out would result in a Status Error when a slow device such as a Plotter was addressed.
- 5) The software updated the screen display during Vertical Retrace Time. The screen is now updated during non VRT giving faster updates.
- 6) The TI\$ function lost time during screen scroll on the business keyboard version.
- 7) Presently a line feed is automatically transmitted after a carriage return causing possible problems when writing to the disk. BASIC 4.0 transmits automatic line feeds only to files with logical file numbers greater than 127.
- 8) Inputting more than 80 characters without a carriage return caused a system crash. BASIC 4.0 generates a ?STRING TOO LONG ERROR.
- 9) The string data garbage collection algorithm has been rewritten so that worst case collection time has been reduced from over 20 minutes to less than 1 second.

The fourteen new disk commands actually perform only two or three new functions but they are much

simpler to use and require less coding. For one thing, there is no longer any need to OPEN or reference the disk COMMAND/ERROR channel, channel 15. Instead of coding OPEN15,8,15:PRINT #15, "V0":CLOSE15 to validate a disk on drive 0, you now write COLLECT. The new DISK BASIC commands default to UNIT 8, DRIVE 0. If you wanted to validate a disk in drive 1 you would write COLLECTD1. The complete set of new DISK BASIC commands is discussed in detail in the following paragraphs.

The three user defined parameters specified with each command are file name, drive number, and unit number. Drive number is the letter D followed by a 0 or 1. The default number is generally 0, or in commands where more than one drive may be specified, the default number for the second drive is the last user specified drive number. The unit number (IEEE Address) is optional on nearly all commands. Unit number is the letter U followed by an integer between 4 and 31. The default value is 8. ON Uz may be written as ,Uz.

File names may be in quotes or represented as a string variable. Variables or expressions to evaluate must be enclosed in parentheses e.g. D(d). The second cassette may not be used simultaneously with DISK BASIC.

The disk status variables DS, and DS\$ cannot be assigned a value by the user, but when referenced by a PRINT command or on the right hand side of an expression, the disk command channel will be read and updated values assigned. The OS keeps a flag to prevent rereading these values if a subsequent disk operation has not been performed.

In the following syntax of command, () parentheses around a parameter mean that the parameter is optional. Lower case alphabet implies a user specified integer. Upper case alphabet characters are required to be included by the user, and "NAME" is any user specified file name.

1) DOPEN #1 "NAME" (,Ly) (cDx) (ON Uz)

Where:

#1 - Logical file number used to associate future

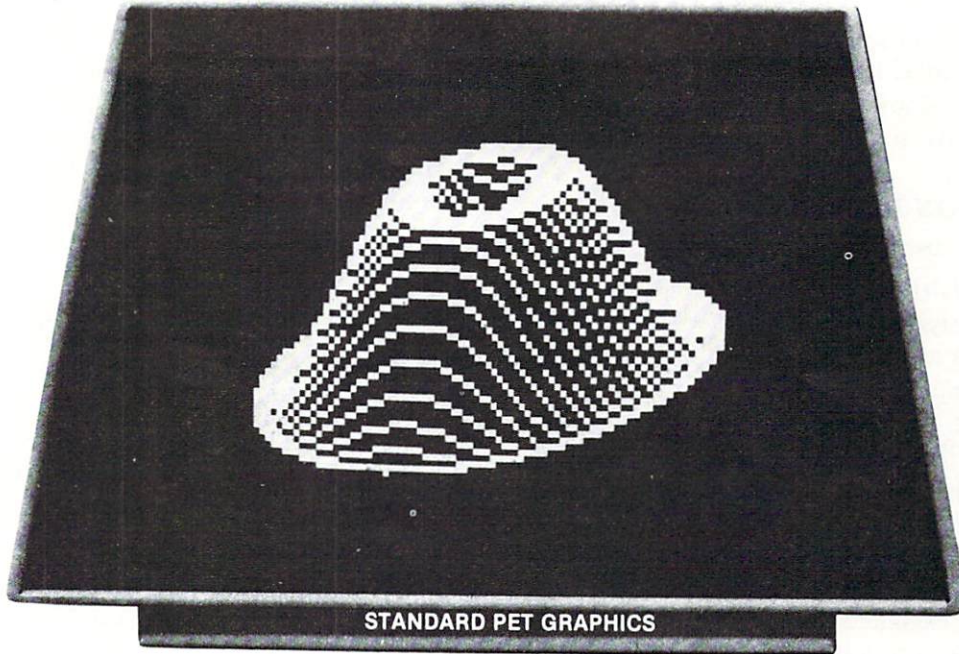

HIGH RESOLUTION GRAPHICS

LOOK TO MTU. WE SUPPORT HIGH RESOLUTION GRAPHICS ON:
PET — AIM — KIM — SYM

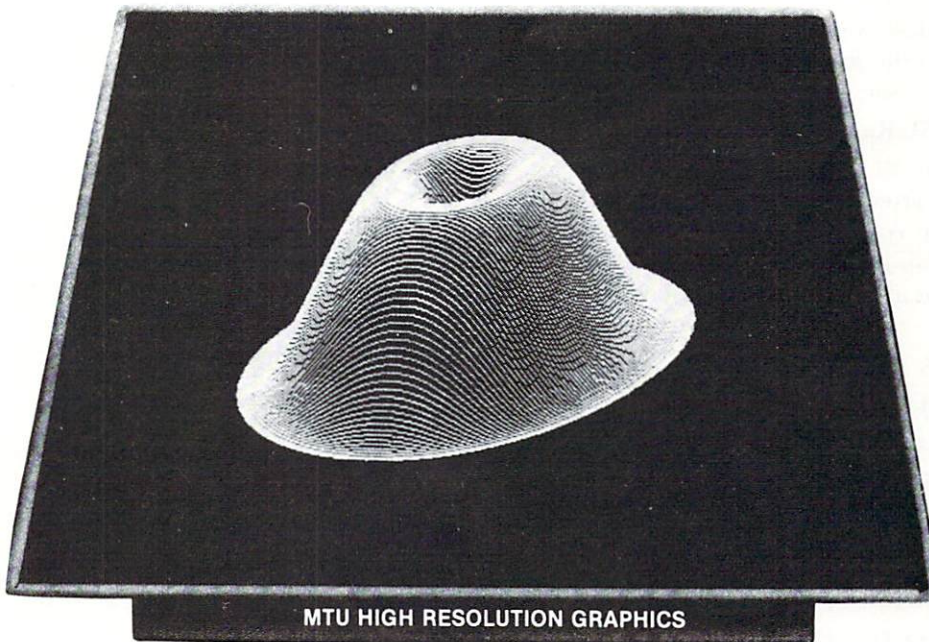

Micro Technology Unlimited

P.O. Box 4596, 841 Galaxy Way
Manchester, N.H. 03108
603-627-1464

Call Or Write For Our Full Line Catalog

disk operations back to this OPEN statement. Any integer between 1 and 254 inclusive.

Ly - Record length. Causes allocation of a random access (relative record) file with a fixed record length of y.

2) DCLOSE (#1) (ON Uz)

Closes all files on a disk if 1 is not specified.

3) RECORD -1,r (,b)

Refers to a previously defined random access file. NOTE: Parameters are position dependent.

r - random record number to be read by the next PRINT#, INPUT#, or GET# statement. Must be between 1 and 65535.

b - character (byte) position within record. Between 1 and 254. Defaults to 1.

RECORD is executed immediately before a GET#, INPUT# to position the disk at the desired record. If RECORD is not executed then the record following the last referenced record will be read.

4) HEADER "NAME" ,Dx (,Izz) (ON 09)

This command replaces the old NEW command and is used to format a disk prior to use. When Izz, a disk ID number, is specified the disk is formatted. Otherwise the directory is cleared and the new name assigned to the disk. This command requires caution in its use because once used, all previous information on the disk is lost. In the direct mode, the OS prints the following message and begins to flash the cursor:

ARE YOU SURE?

You must enter Y or YES and press return or the operation will be aborted. If during the HEADER operation, a problem is encountered such as a missing disk, write protect tab on, or bad disk surface, the operation will be aborted with the following message:

? BAD DISK

5) COLLECT (Dx) (ON Uy)

Frees up space allocated to improperly closed files on the disk and deletes their reference from the directory. Also verifies the bit allocation map stored on the disk. Relative Record files are maintained but Random Access files created through BLOCK-WRITE commands are lost.

6) BACKUP Dx TO Dy (ON Uz)

Replaces the old DUPLICATE command. Duplicates the entire contents of disk x onto disk y. All information on disk y is lost. This version is faster than the DUPLICATE command with duplication time reduced from 6 minutes down to 2 minutes 15 seconds. Reliability is improved through the use of a error counter not available in the earlier version.

7) COPY (Dx,) "NAMEx" TO (Dy,) "NAMEy" (ON Uz)

COPY Dx TO Dy (ON Uz)

The COPY command functions only between drives within a single unit. It can copy files from disk to disk or within the same disk. COPY without file names (second version) copies all files from disk x to disk y without disturbing files already residing on disk y. If a file being copied from disk x already exists on disk y the operation will be aborted with a #63 error.

8) CONCAT (Cx,) "NAMEx" TO (Dy,) "NAMEy" (ON Uz)

Concatenates file x to file y. BASIC program files will be concatenated but not chained together.

9) DSAVE "NAME" (,Dx) (ON Uy)

Save a BASIC program file onto disk x.

10) DLOAD "NAME" (,Dx) (ON Uy)

Load a BASIC program file into memory from disk x.

11) DIRECTORY (Dx) (ON Uy)

Displays the directory from disk x onto the screen. Displays both directories if x is not specified.

12) RENAME (Dw,) "NAMEx" TO "NAMEy" (ON Uz)

RENAMES a file on disk w from name x to name y. The Rename command in version 1.2 had a bug which has been corrected.

13) SCRATCH (Dx,) "NAME" (ON Uy)

SCRATCHES the named file from disk x. When used in the direct mode, ARE YOU SURE? is displayed and you must key Y or YES and RETURN or the operation is aborted. Open files may not be SCRATCHED.

At this writing the price for DISK BASIC is unknown but I would seriously consider it's purchase if you are presently using a Commodore disk with your PET. Just replace the present ROMs in your PET and disk unit with the new DISK BASIC ROMs and you're in business.

Next issue we will cover the use of Relative Record files in detail and give some inside information on it's use like why only three Relative Record files can be open simultaneously. If you studied the Direct Access file methods outlined in issues 1 and 2 of Compute you will have a better understanding of what is actually taking place, but all of those commands and programming techniques apply to DOS 1.2.

Many thanks to everyone at Commodore, especially Larry Perry, for their assistance in preparing this article.

DTI and Commodore.

A program that's tough to beat.



Send me more information on the DTI program and Commodore.

Name

Company

Address

City

State Zip

8002-D Haute Court, Springfield, Virginia 22150 (703) 455-4800

We supply computer dealers with an unparalleled program of service. We offer not only the best pricing available, but also the most rapid off the shelf delivery on the East Coast. Of course, we carry the top brand name products, including the remarkable Commodore line. And we back the products we sell with outstanding service and dealer support. That's the DTI program.



DTI
Office
Products,
Inc.

Programmed for dealer support.

Professional Business Software

For The Commodore 32K Microcomputer System
With 2040 Dual Drive Disk & 2022 Tractor Feed Printer

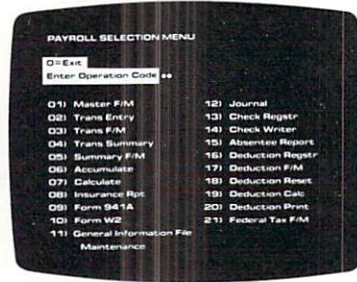
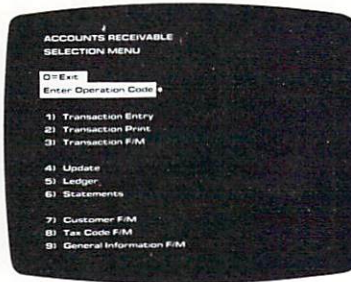
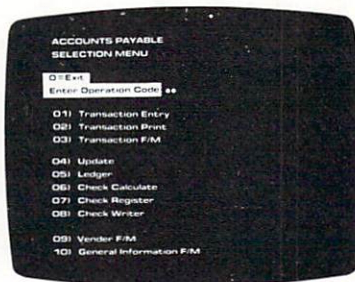
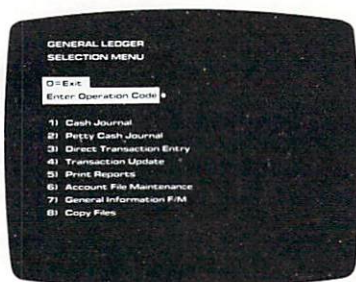

General Ledger

- Holds Up To 300 Accounts.
- Accepts Up To 3000 Transactions Per Month.
- Cash Disbursements Journal, Cash Receipts Journal, and Petty Cash Journal for simplified data entry.
- Maintains Account Balances For Present Month, Present Quarter, Present Year, Three Previous Quarters, And Previous Year.
- Complete Financial Reports Including Trial Balance, Balance Sheet, Profit & Loss Statement, Cash Receipts Journal, Cash Disbursements Journal, Petty Cash Journal and more.
- Accepts Postings From External Sources Such As Accounts Payable, Accounts Receivable, Payroll, Etc. **\$295.00**

Accounts Payable

- Interactive Data Entry With Verified Input And Complete Operator Prompting.
- Automatic Application Of Credit And Debit Memos.
- Maintains Complete Purchase Records For Up To 200 Vendors.
- Invoice File Accepts Up To 400 Invoices.
- Random Access File Organization Allows Fast Individual Record Updating.
- Multiple Reports Provide A Complete Audit Trail.
- Check Printing With Full Invoice Detail.
- Full Invoice Aging.
- Automatic Posting To General Ledger . . . **\$195.00**

Accounts Receivable

- Maintains Invoice File For Up To 300 Invoices.
- Accommodates Full Or Partial Invoice Payments.
- Customer File Maintains Purchase Information For Up To 1000 Customers.
- Allows For Automatic Progress Billing.
- Provides For Credit And Debit Memos As Well As Invoices.
- Prints Individualized Customer Statements.
- Interactive Data Entry With Full Operator Prompting.
- Complete Data Input Verification And Formatting.
- Automatic Posting To General Ledger . . . **\$195.00**

Payroll

- Maintains Monthly, Quarterly, And Yearly Cumulative Totals For Each Employee.
- Payroll Check Printing With Full Deduction And Pay Detail.
- Sixteen Different Reports Including W2 And 941.
- Interactive Data Entry With Easy Correction Of Entry Errors.
- Automatic Data Verification.
- Complete Job Costing Option With Cumulative Totals And Overhead Calculations.
- Random Access File Organization For Fast Updating Of Individual Records.
- Automatic Posting To General Ledger . . . **\$295.00**

Structured around the time tested and reliability proven series of business software systems developed by Osborne and Associates, these programs have been designed to fill the need of a comprehensive accounting package for the new Commodore PET micro computer system. Each program can either stand alone, or be integrated with the others in a total software system.

Designed with the first time user in mind, these programs lead the operator through step by step, verified data entry. It is impossible to 'crash' a program due to operator error or invalid data input. Design consistency has been maintained from program to program to greatly increase operator familiarity and confidence.

Documentation, normally a problem for small systems users, is provided by the comprehensive series of Osborne

and Associates user manuals. These three manuals together total over 800 pages of detailed step by step instructions written at three levels for DP Department Managers, Data Entry Operators, and Programmers. You don't have to worry about getting 'promises' instead of documentation because the documentation was written before the programs were developed. A second set of manuals details any changes required during conversion. Each program provided on disk with complete documentation. Packaged in a handsome three ring binder with pockets and twelve monthly dividers for convenient storage of reports.

See your nearest Commodore dealer for a demonstration of this outstanding business software system.

CMS Software Systems

5115 MENEFFEE DRIVE • DALLAS, TX 75227 • 214-381-0690

ENHANCING COMMODORE'S WORD PRO II

Larry Isaacs, COMPUTE. Staff

One of the nice features of the NEC Spinwriter is the ability to change print thimbles. This allows you a choice of characters of different sizes and shapes as well as thimbles with different sets of special characters. The special characters available on various thimbles include such things as copyright and trade mark symbols, plus many technical and foreign language symbols and characters. Unfortunately, Commodore's word processing systems do not allow you to use these special symbols. However, with a little work this can be fixed. This article will deal with upgrading the WordPro II program for a CBM system. It will allow you to use nine special characters which is sufficient to print all of the characters on most of the thimbles. A later article will deal with making a similar upgrade to WordPro III.

While using the upgraded WordPro II, you may enter the special characters by first hitting the REPEAT key. This has no effect except to turn on a special character flag. If the next key struck is a numeric key from 1 to 9, a corresponding special character is entered and will be displayed on the screen as one of the graphics characters. If it is some other key, the normal character is entered and displayed. In either case the keystroke following the REPEAT key will turn off the special character flag, unless it is another REPEAT key. In this case the special character flag remains on. Once entered in the text, this special character will be treated like any of the other characters. However, when one of these special characters is encountered during printing, it is replaced with the ASCII code or codes which print the corresponding special symbol.

The Upgrade Procedure

The first step is to make sure that your copy of the ASC EDITOR is the same as the one I worked on. This is the version of WordPro II for use with an ASCII printer. Place the work copy (don't use your original) of your Word Pro II disk in Drive 0 and load in your copy of the ASC EDITOR by typing Commands #1 and #2.

```
Command #1   open1,8,15,"i0"
Command #2   load "0:asc editor",8
```

Now type SYS1024 to enter the machine language monitor. The monitor will display the register information, and then prompt with a period. Any commands shown which start with a period are for the machine language monitor. The other commands are for the normal operating system, which may be reached from the machine language monitor by a ".x" command.

Next type, in turn, Commands #3, 4, and 5, exactly as shown. Check after each command to see if the contents of memory displayed match what is given just below each command. If your memory matched what is shown with the commands, then the following patches to your ASC EDITOR should work. If yours doesn't match, then write a letter to COMPUTE. explaining the situation. We may be able to come up with the patches for your version. Hopefully, everybody's version is the same.

```
Command #3   .m 033a 0341
              .: 033a 98 48 20 e4 ff 85 30 f0

Command #4   .m 143c 1443
              .: 143c 48 29 40 0a 85 3f 68 29

Command #5   .m 1e3c 1e43
              .: 1e3c a9 31 85 90 60 46 20 3a
```

The next step is to enter the machine code patches into memory. To do this, type Command #6. Then cursor up to the first line of displayed memory on your screen. Now enter the machine code by cursoring past the four digit hex number, which is the address. Then type the hex number shown in the first line below Command #4 over the numbers displayed on the screen. When you reach the end of the line, hit carriage return. In the same manner, enter the numbers in each of the other lines shown below Command #6 into the corresponding lines on the display. Be sure to hit carriage return at the end of each line since this is what causes your changes to be placed into memory. Once you have completed this procedure for Command #6, repeat the procedure for Command #7.

```
Command #6   .m 027a 02ef
              .: 027a 20 c1 02 8d ec 02 8e ed
              .: 0282 02 a6 9e f0 27 ca bd 6f
              .: 028a 02 c9 7f f0 18 4e ee 02
              .: 0292 90 1a c9 00 30 16 c9 31
              .: 029a 90 12 c9 3a b0 0e 09 80
              .: 02a2 9d 6f 02 d0 07 a9 01 8d
              .: 02aa ee 02 86 9e ad eb 02 48
              .: 02b2 ad ea 02 48 ad e9 02 48
              .: 02ba ad ec 02 ae ed 02 40 ba
              .: 02c2 bd 06 01 8d e9 02 09 04
              .: 02ca 9d 06 01 bd 07 01 8d ea
              .: 02d2 02 bd 08 01 8d eb 02 18
              .: 02da 68 69 01 9d 07 01 68 69
              .: 02e2 00 9d 08 01 4c 31 e6 00
              .: 02ea 00 00 00 00 00 00 00
```

```

Command #7      .m 3f7d 3fe7
                :: 3f7d 78 a9 7a 85 90 a9 02 85
                :: 3f85 91 a9 4c 8d 3c 14 a9 a8
                :: 3f8d 8d 3d 14 a9 3f 8d 3e 14
                :: 3f95 a9 ea 8d 3c 1e 8d 3d 1e
                :: 3f9d 8d 3e 1e 8d 3f 1e 58 4c
                :: 3fa5 0d 04 aa c9 5b 10 06 48
                :: 3fad 29 40 4c 3f 14 c9 71 90
                :: 3fb5 24 c9 7a b0 20 29 0f aa
                :: 3fbd e0 08 10 09 bd dd 3f 20
                :: 3fc5 6f b1 4c 58 14 a9 0e 20
                :: 3fcd 6f b1 bd dd 3f 20 6f b1
                :: 3fd5 a9 0f 20 6f b1 4c 58 14
                :: 3fdd 00 5e 5c 60 7c 7b 7d 7e
                :: 3fe5 58 5a aa aa aa aa aa
    
```

TABLE 1

Special Character	ASCII Characters Output (Hex)
1	5E
2	5C
3	60
4	7C
5	7D
6	7B
7	7E
8	0E,58,0F
9	0E,5A,0F

Next, execute Commands #8 and 9. This will save the patches under the file names in the commands.

```

Command #8 .s '0:patch 1',08,027a,02ef
Command #9 .s '0:patch 2',08,3f7d,3fe7
    
```

This completes the upgrade process. To run the upgraded WordPro II, use the command sequence given by Commands #10 through #14. Since the ASC EDITOR and the patches are already in memory, type the command ".x" then command #14 to run your upgraded word processor.

```

Command #10 openl,8,15,'i0'
Command #11 load '0:patch 1',8
Command #12 load '0:patch 2',8
Command #13 load '0:asc editor',8
Command #14 sys16253
    
```

The ASCII Output

Table 1 shows the ASCII code which is output for each of the special characters. Note that for special characters #8 and 9, a three code sequence is required. Also shown in the table are the actual characters printed for two of the thimbles. These two thimbles as well as a few of the others have the advantage of printing the same character on paper as you see on the screen for all the characters normally printed by WordPro II. The other thimbles have some of the special characters mapped into WordPro's normal character set. For example, on the Courier Legal 10A thimble, a "/" on the screen would be printed as a "®". The best way to determine what will be printed is to get a Print Thimble Allocation chart from your NEC sales representative.

A Final Note

There are other thimbles, such as the Technical/Math thimble, which have about 30 more special symbols than the ones handled by the upgrade presented here. An upgrade for these could be done, but a new procedure for entering and displaying the characters would have to be defined. There aren't 30 more character codes which can be displayed on the screen.

And for those who are willing to go to the trouble, you could make a new character generator with a 2716 or equivalent (single 5 volt supply) that would display the proper special symbol on the screen.

Thimble Character Printed	
Courier 10	Courier Legal 10B
^	°
\	®
	°
{	¶
}	§
~	†
£	™
£	™

Reproduce and Attach Above Numeric Pad

7=˘	8=¬	9=£
4=	5={	6=}
1=^	2=\	3=`

7=™	8=	9=
4=¶	5=§	6=†
1=°	2=°	3=°

Trenton Computer Festival

The Trenton Computer Festival (TCF), the original Personal Computer show, will happen again, on April 19-20, 1980.

The fifth annual T.C.F. will be two full days, with a huge 5-acre outdoor flea market and indoor commercial exhibitor area for up to 90 booths. There will be 30 speakers, user group sessions and demonstrations galore. There will be hundreds of door prizes.

Computer conference sessions and forums will be held on: microcomputers in the home, education, medicine, amateur radio, music and the arts. There will be User Group sessions on Saturday and special tutorial sessions for the general public and novice on Sunday.

It is expected that attendance will exceed 9,000, up from 6,000 last year. There will be a Saturday night banquet with renowned speakers. There will be free parking for 5,000 cars.

TCF-80 will be held at Trenton State College, just outside of Trenton, N.J., convenient to New York City, Philadelphia and Baltimore.

Admission is \$5 for the two days (\$2 for students). The Saturday night banquet is \$10. Flea Market spots are \$5 per day.

TCF-80 is a non-profit undertaking and is sponsored by: Amateur Computer Group of N.J.,

Philadelphia Area Computer Society, Trenton State College Computer Society, Institute of Electrical & Electronic Engineers - Princeton Section and the Department of Engineering Technology, Trenton State College.

For more information, contact:

Dr. Allen Katz, Trenton State College, Hillwood Lakes, P.O. Box 940, Trenton, N.J. 08625/609-771-2487, Sol Libes, Amateur Computer Group of New Jersey, UCTI, 1776 Raritan Road, Scotch Plains, N.J. 07076

©

CMS Software Signs Canadian Distributor

CMS Software has announced that Computer Specialists (944 Wilson Avenue, Toronto, Ontario, CANADA M3K 1E7, 416-633-5605) is licensed to distribute and produce CMS Software products in Canada. According to Chuck Stuart, President of CMS, the licensing agreement includes the entire line of Osborne business software packages currently marketed in the U.S. by CMS.

©

Micro Computer Industries, Ltd.

1520 East Mulberry Suite 240
Ft. Collins, Colorado 80524
Phone 303 221-1955

CBM or PET Inventory Control

Cassette version, 8K PET

\$39.95

Disk version, 2500 items per drive with history and data base management. Writes purchase orders; sorts by 10 fields; no computer experience required.

\$100.00

Accounts Receivable

\$39.00

Accounts Payable

\$39.00

General Ledger

\$200.00

A complete general ledger which is interactive with the inventory, accounts receivable and accounts payable programs. Generates all its own account numbers. Issues complete reports, statements and summaries.

Instructions \$25.00 refundable with purchase

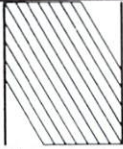

NEECO

Microcomputer Systems Division

**PROUDLY ANNOUNCES THE NEWEST
HARDWARE AND SOFTWARE FOR YOUR PET!**

The PET is now a truly sophisticated
Business System with the announcement
of these peripherals and software packages.



**FREE
SOFTWARE
& PET DUST
COVER!**
(Offer ends
2/28/80)

NEW
NEW
NEW

PRODUCT	DESCRIPTION	PRICE	AVAILABILITY
PET 2001—8KN (Large Keys)	8K RAM	\$ 795	IMMEDIATE
PET 2001—8K	8K RAM	\$ 795	IMMEDIATE
PET 2001—16KN (Large Keys)	16K RAM*	\$ 995	IMMEDIATE
PET 2001—32KN (Large Keys)	32K RAM	\$1295	IMMEDIATE
PET 2023 PRINTER	ROLL FEED	\$ 695	IMMEDIATE
PET 2022 PRINTER	TRACTOR/ROLL	\$ 795	IMMEDIATE
ROMRETRO KIT	UPDATED O/S	\$ 90	IMMEDIATE
PET 2040	DUAL FLOPPY*	\$1295	IMMEDIATE
PET C2N	2nd Cassette	\$ 95	IMMEDIATE

*The 16K/32K (large keyboard) units do not include a cassette drive. Order C2N Cassette. 2040 Floppy Drive requires a 16K or 32K unit. 8K RAM Retrofit available July.

ALL PETS ARE FULLY TESTED BY NEECO BEFORE SHIPMENT. NEECO IS A FULL CUSTOMER-ORIENTED COMPANY. CALL FOR OUR FREE CATALOG. ALL ORDERS OVER \$795 WILL RECEIVE A FREE NEECO PET DUST COVER AND \$100 OF SOFTWARE FROM OUR CATALOG IF YOU MENTION YOU SAW THIS AD.

PET-DISK BASED BUSINESS SOFTWARE

SOFTWARE/APPLICATION	REQUIRES	AUTHOR	AVAILABILITY	PRICE
WORDPRO II / WORD PROCESSING	2040 + 16K PET	PRO/MICRO	IMMEDIATE	\$100
WORDPRO III / WORD PROCESSING	2040 + 32K PET	"	JANUARY	\$200
GENERAL LEDGER	"	CMS SOFTWARE	IMMEDIATE	\$295*
ACCOUNTS PAYABLE	"	"	JANUARY	\$295*
ACCOUNTS RECEIVABLE	"	"	JANUARY	\$295*
MAILING LIST	"	"	IMMEDIATE	\$100
MICROLEDGER	"	COMPUMAX	"	\$140
MICROPAY	"	"	"	\$140
MICROREC	"	"	"	\$140
MICROINV	"	"	"	\$140
MICROPERS	"	"	"	\$140

*The CMS Software (G/L, A/R, A/P) are based on Osborne & Associates trial tested business basic software. Software is complete with full documentation and user instructions. All packages require a printer for output. Commodore recommends the NEC Spinwriter (available from NEECO) as the output printer for WORDPRO.

PRODUCTS ARE AVAILABLE TO DEALERS VIA MICROAMERICA DISTRIBUTING (617-449-4310)

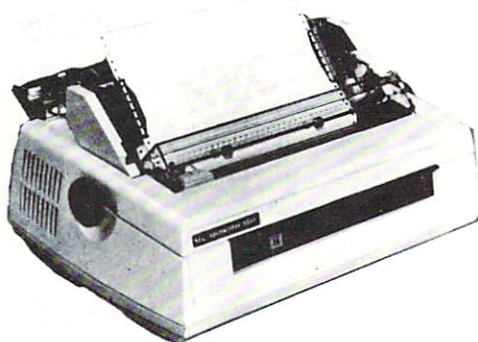

**FOR WORD PROCESSING
NEC IS BEST!**

- * 55 characters per second output speed
- * Changeable thimble for different typesyles
- * Less than 1% warranty malfunction rate
- * IBM quality letter output
- * Dealer inquiries invited

\$2995

*Price includes IEEE interface to PET. IEEE Port is available for use with 2040 Dual Disk.

**THE NEC SPINWRITER
MODEL 5530-P** (Centronics I/O modified for PET)

*The NEC 5530-P is the output printer recommended by Commodore for their Word Processing System.



NEECO
679 Highland Ave.
Needham, MA
02194

Mon-Fri 9:30-5:30
MasterCharge &
Visa Accepted
(617) 449-1760
Telex: 951021

MICROAMERICA DISTRIBUTING
"Nationwide distributors of Computer Equipment"
21 Putnam Street
Needham, MA
02194
(617) 449-4310

FILE CONVERSIONS ON THE COMMODORE 2040 DRIVE

Hal Wadleigh
15 Lantern Lane
Medfield, MA 02052

The vast majority of business systems using PETs and CBM's are attached to a 2040 disk drive. One of the reasons is that Wordpro (the word processing system) can turn the CBM-2040 combination into one of the most cost-effective word processing machines on the market. The other applications which can also be programmed for the same equipment are a nice bonus, but Wordpro usually pays for the system.

The initial concept behind Wordpro was for the word processing function to be distinct from other functions. The software design was predicated on the assumption that Wordpro files would not have to be accessed by other programs. Consequently, the files were designed in program blocks -- not as ASCII data files. Time has proven that assumption to be inaccurate. Many text files created in Wordpro contain information that is often necessary for other computer functions and Wordpro documents often need data from ASCII files created by other functions.

The problem has a fairly simple solution -- two conversion programs. One maps Wordpro files into ASCII files and the other performs the reverse mapping function.

The attached program listings will not be very meaningful without some explanation of the way Wordpro files are structured. Wordpro files are programs, not sequential files. A carriage return by the operator puts a back-arrow into the text and moves the cursor to the start of the next screen line. Since the file is actually a program, the first two bytes of the file are a reverse-format integer designating the address at which the program should begin loading. Luckily, the 2040 DOS allows single character GETs from a program file. It may be OPENed in the same way a sequential file is opened, and the status word (dedicated variable ST) can be used to find the end of the file.

In the attached listing of the Wordpro to ASCII conversion program, the subroutine at line 10000 sets up the character conversion table. Characters in Wordpro files are in screen code, not ASCII. The subroutine at 1000 is the error checking and end-of-file scanning routine. These two techniques are the key elements in file conversion for these kinds of files. The structural differences between the file types is handled by simply throwing out the two pointer bytes

at the beginning of the file. The program listed does this with a pair of initial GETs and is processed by replacing it with a carriage return and throwing out the additional blank spaces behind the back arrow. That is the reason that it is necessary to keep track of the screen column from which the Wordpro character came (C% in the program).

The program which does the reverse conversion uses the same basic techniques, but re-inserts the pointer and padding blanks that are discarded in the other program.

Word processing is the foremost application for all microcomputers today. Now it doesn't have to be an entirely separated function on 2040 systems, but can be integrated into a cohesive data processing system for small businesses. Invoices generated in Wordpro can be converted and merged into an order-processing system. Block file lists generated and maintained in Wordpro can be converted for a demographic analysis. Mailing list label data can be converted into Wordpro block files for use in customized mass mailings. The possibilities are endless.

There are other instances where the same type of file conversion techniques may be useful -- converting the CBM altered ASCII set to standard ASCII for output to a printer is one example. The principle involved is to do as much of the conversion as possible in a table and to program only those functions that cannot be mapped. It's easier and faster that way.

```

5 POKE59468,14:GOSUB10000
7 PRINT"WORDPRO TO ASCII CONVERSION":
  -PRINT
10 INPUT"WORDPRO FILE NAME .<<<";F$:
  -IFF$=".GOTO10
20 INPUT"DRIVE NUMBER .<<<";A$:A=ASC(A$)
  -48:IFA<0ORA>1GOTO20
30 INPUT"ASCII FILE NAME .<<<";AF$:
  -IFAF$=".GOTO30
40 INPUT"DRIVE NUMBER .<<<";A$:B=ASC(A$)
  -48:IFB<0ORB>1GOTO40
50 A$=CHR$(A+48):B$=CHR$(B+48):OPEN15,8,
  -15:PRINT#15,"I"+A$
60 IFB$<>A$THENPRINT#15,"I"+B$
70 F$=A$+":"+F$+",P,R":REM DRIVE#:
  -FILE NAME,PROGRAM,READ ACCESS
80 OPEN1,8,2,F$:GOSUB10000:REM OPEN AND -
  -CHECK

```

```

90 AF$=B$+"":AF$+"",S,W":REM DRIVE#:
  -FILE NEME,SEQUENTIAL,WRITE ACCESS
100 OPEN2,8,3,AF$:GOSUB1000
110 GET#1,A$:GOSUB1000:REM SKIP POINTER,
  - LOW BYTE
120 GET#1,A$:GOSUB1000:REM SKIP POINTER,
  - HIGH BYTE
130 C%=39:REM INITIALIZE COLUMN COUNTER
140 GET#1,A$:C%=C%+1:IFC%>39THENC%=0
150 IFA$=CHR$(31)GOTO170:REM CARRIAGE -
  -RETURN
160 PRINT$(ASC(A$));:PRINT#2,T$(ASC(A$))
  -;:GOSUB1000:GOTO140
170 PRINT:PRINT#2,CHR$(13);:IFC%=39GOTO14
  -0:REM NO PADDING
180 FORI=C%TO38:GET#1,A$:GOSUB1000:
  -IF(ASC(A$)AND63)<>32THENPRINT:
  -PRINT"rFILLER ERROR":STOP
190 NEXT:GOTO130:REM FILLER(CHARACTER 32 -
  -OF 160) HAS BEEN DELETED
200 END
1000 SA%=ST:REM TEMPORARY STORAGE OF -
  -STATUS WORD
1010 INPUT#15,E,E$,T,S:IFE<1GOTO1040:
  -REM DISK ACTION OK
1020 PRINT:PRINT"rDISK ERROR";E;E$:
  -PRINT"TRACK=";T;"SECTOR=";S:
  -PRINT"STATUS=";SA%
1030 CLOSE1:CLOSE2:CLOSE15:END
1040 IFSA%=0THENRETURN:REM ALL OK
1050 M$="STATUS ERROR="+STR$(SA%):
  -IFSA%=64THENM$="FILE CONVERTED"
1060 PRINT:PRINT"r";M$:GOTO1030
1070 REM END OF ERROR CHECKING SUBROUTINE
10000 DIMT$(255):REM TRANSLATION ARRAY
10010 FORI=0TO31:T$(I)=CHR$(I+64):NEXT
10020 FORI=32TO63:T$(I)=CHR$(I):NEXT
10030 FORI=64TO95:T$(I)=CHR$(I+128):NEXT
10040 FORI=96TO127:T$(I)=CHR$(I+64):NEXT
10050 FORI=128TO255:T$(I)="r"+T$(I-128)+"
  -r":NEXT
10060 RETURN
50 INPUT"WORDPRO FILE NAME .<<<<";WF$:
  -IFWF$="".GOTO50
60 INPUT"DRIVE .<<<<";D$:WD=ASC(D$)-48:
  -IFWD<0ORWD>1GOTO60
70 F$=RIGHT$(STR$(D),1)+":"+F$+"",S,R":
  -WF$=RIGHT$(STR$(WD),1)+":"+WF$+"",P,
  -W"
80 OPEN15,8,15:PRINT#15,"I":GOSUB1000:
  -OPEN1,8,2,F$:GOSUB1000
82 OPEN2,8,3,WF$:GOSUB1000:L%=0:CB=WP+2:
  -R%=0
85 PRINT#2,CHR$(8)+CHR$(48);:GOSUB1000:
  -REM INITIAL POINTERS
90 GET#1,A$:SA=ST:GOSUB1000:IFA$=""GOTO170
95 IFA$=CHR$(13)THENPRINT"~":GOTO120
96 PRINTA$;
100 IFA$="r"THENR%=1:GOTO170
110 IFA$="r"THENR%=0:GOTO170
120 BV=T$(ASC(A$)):IFBV=0ANDAS<>"@GOTO170
125 IFR%=1THENBV=BV+128
130 PRINT#2,CHR$(BV);:CB=CB+1:L%=L%+1:
  -IFL%>39THENL%=0
140 IFA$<>CHR$(13)GOTO160
150 IFL%>0THENFORI=L%TO39:PRINT#2," ";:
  -CB=CB+1:NEXT:L%=0:R%=0
160 IFCB>EWGOTO210:REM END OF WORKSPACE
170 IFSA<1GOTO90
180 IFSA=64GOTO200
190 PRINT:PRINT"rSTATUS ERROR";SA:END
200 PRINT:PRINT"rFILE CONVERTED":CLOSE2:
  -GOSUB1000:CLOSE1:GOSUB1000:CLOSE15:
  -END
210 PRINT:PRINT"rWORKSPACE FULL--CHAINING -
  -FILE":CLR2:GOSUB1000
220 WF$=LEFT$(WF$,LEN(WF$)-4)+STR$(C%)+",
  -P,W":GOTO82
1000 INPUT#15,E,E$,T,S:IFE<1GOTO1020
1010 PRINT:PRINT"rDISK ERROR";E;E$:
  -PRINTT,S,SA:END
1020 IFSA<1ORSA=64THENRETURN
1030 PRINT:PRINT"rSTATUS ERROR";SA:END
2000 DIMT%(255)
2010 T%(13)=31:REM WORDPRO RETURN MARKER
2020 FORI=64TO95:T%(I)=I-64:NEXT
2030 FORI=32TO63:T%(I)=I:NEXT
2040 FORI=192TO223:T%(I)=I-128:NEXT
2050 FORI=224TO255:T%(I)=I-64:NEXT
2060 RETURN

```

COMPUTE NOTES: The pointer found at the beginning of the WORDPRO II files will vary depending on the number of lines of main text you specified. Since WORDPRO II doesn't use this pointer when loading files, you could increase the workspace in the ASCII TO WP program by reducing the value assigned to WP in line 20. Just make sure that you declare enough main text in WORDPRO to accommodate the file.

Use abbreviations in lines 180 ad 1020 of the WORDPRO TO ASCII program to keep from exceeding the limit of 80 characters per line, i.e. use "gE" for "get#" and "?" for "print".

Also, the "~" character in line 95 of the ASCII TO WORDPRO program represents a backarrow character.

```

5 POKE59468,14:GOSUB2000
7 PRINT"rASCII TO WORDPRO CONVERSION":
  -PRINT
10 EL=PEEK(52):EH=PEEK(53):REM POINTERS -
  -TO END OF MEMORY
20 WP=12296:EW=EL+256*EH-1:REM $3008--BEGI
  -NNING & END OF WORDPRO WORKSPACE
30 INPUT"ASCII INPUT FILE .<<<<";F$:
  -IFF$="".GOTO30
40 INPUT"DRIVE .<<<<";D$:D=ASC(D$)-48:
  -IFD<0ORD>1GOTO40

```

Program Listings for COMPUTE

In order to eliminate the need for manually converting programs for listing on our Spinwriter, we have substantially increased the intelligence of our PET-to-Spinwriter interface. The interface now handles the conversions for the cursor control and graphics characters, as well as breaking the longer BASIC statements into multiple lines so the listing will fit our columns better. This means we can test the programs whenever possible and then list them without changes. It also means that our previous request to limit the line length to 38 characters may be ignored. Here is how the listings should be interpreted. Cursor control characters will appear in source listings

as shown below:

h=HOME , ĥ=CLEAR SCREEN
 ↓=DOWN CURSOR , ↑=UP CURSOR
 >=RIGHT CURSOR, <=LEFT CURSOR
 ⌊=REVERSE , ⌋=REVERSE OFF

Graphics (i.e. shifted) characters will appear as the unshifted alphanumeric character with an underline. This does not apply to the cursor control characters. The Spinwriter thimble doesn't have a backarrow symbol, so a '˘' is used instead.

The '␣' is used to indicate the beginning of a continuation line. It is also used to indicate the end of a line which ends with a space. This prevents any spaces from being hidden.

TEXTCAST™

Turn your PET into a WORD PROCESSOR comparable to large systems for a fraction of the cost!

CREATE-REVIEW-EDIT FILES ON TAPES OR DISKS

PRINT TEXT-LETTERS-FORMS-TABLES

TEXTCAST FITS YOUR PET SYSTEM, OLD AND NEW ROMS

CLEAR INSTRUCTIONS!

Prices: Tape plus manual, \$60.
 Diskette plus manual, \$65.
 Manual separately, \$20.

Write: TEXTCAST
 P.O. Box 2592
 CHAPEL HILL, N.C. 27514

PET Trademark of Commodore Business Machines, Inc.

DISK GENERAL LEDGER maintains complete financial information on diskette. Utilizes printer and generates Trial Balance, Profit/Loss Statement, Balance Sheet and Journal. Enables user to edit data, close out year end accounts and debit-credit verification.

INTERNATIONAL ENTERPRISES INC.				
TRIAL BALANCE				
JANUARY 1978				
ACCT SUB	ACCOUNT TITLE	REF #	DATE	CURRENT AMOUNT
302 00		000	1/78	561.50CR
302 00	JOURNAL ENTRY	000	1/78	440.00
302 00		000	1/78	210.00CR
302 00		000	1/78	310.00CR
				2529.40CR
303 00	GAS & OIL & GREASE	12/77		3167.49CR
303 00	PARTS	000	1/78	446.95CR
301 00		000	1/78	900.31CR
303 00	JOURNAL ENTRY	000	1/78	524.58CR
				3712.07CR
304 00	ACCESSORIES	12/77		.00
				.00
305 00	OUTSIDE WORK	12/77		.00

INTERNATIONAL ENTERPRISES INC.				
STATEMENT OF PROFIT/LOSS				
FOR PERIOD ENDING JANUARY 1978				
	CURRENT PERIOD	YEAR TO DATE		
INCOME				
PARTS SALES	1.57CR	16.97	20.58CR	1774.06CR
LABOR SALES	59.34CR	641.50CR	293.34CR	2529.40CR
GAS & OIL & GREASE	45.53CR	524.66CR	43.56CR	3712.07CR
ACCESSORIES	0.00	0.00	0.00	0.00
OUTSIDE WORK	0.00	0.00	0.00	0.00
HANDLES FEES	17.57CR	190.00CR	2.20CR	190.00CR
AIRFARE REBT	23.53CR	258.69	4.76CR	410.55CR
SEMI-TRUCK INCOME	0.00	0.00	0.00	0.00
OTHER INCOME	4.62CR	4.62CR	5.33CR	4.62CR
TOTAL INCOME	100.00CR	1080.88CR	100.00CR	8616.56CR
COST OF SALES				
MERCHANDISE PURCHASE	119.91CR	1296.09	42.25CR	3946.81
CONTRACT LABOR	0.00	0.00	0.00	0.00
GAS & OIL PURCHASES	186.36CR	2236.25	56.79CR	4893.40
TOTAL COST OF SALES	306.27CR	3532.34	99.04CR	8534.21
GROSS PROFIT	208.29CR	2251.46	.95CR	82.35CR
EXPENSES				
SALARIES	0.00	0.00	5.12CR	441.92
RENT	26.83CR	290.00	6.15CR	530.00
ADVERTISING	0.00	0.00	.27CR	23.40

INTERNATIONAL ENTERPRISES INC.				
BALANCE SHEET				
JANUARY 1978				
ASSETS				
CASH ON HAND	740.11CR			
CASH IN BANK	2190.53			
INVENTORY OF PARTS	1119.00			
EQUIPMENT	4114.50			
ACCUMULATED DEPRECIATION	.00			
BUSINESS VEHICLES	.00			
BUSINESS RECEIVABLE	20000.00			
ACCUMULATED DEPRECIATION	642.07CR			
METER DEPOSITS	.00			
TOTAL ASSETS		26041.85		

SAWYER SOFTWARE

SAWYER SOFTWARE OFFERS a complete line of cassette and disk based business software for your PET or TRS-80 computers. Each program has been specifically designed for ease of use and come with instruction manuals. SAWYER SOFTWARE'S disk packages run on Commodore, Compu-Think or TRS-80 disk systems with 32K and at least one disk drive. Call or write for free brochure.

201 Worley Rd.
 Dexter, Mo. 63841
 (314) 624-7611



Dealer Inquires
 Are Invited



Telephone Orders Welcome

INTERNATIONAL ENTERPRISES INC.				
JOURNAL				
JANUARY 1978				
ACCT SUB	DESCRIPTION	REF #	DATE	AMOUNT
230 00		000	1/78	25.82CR
301 00		000	1/78	30.00CR
301 00		000	1/78	358.36CR
301 00		000	1/78	30.94CR
301 00	JOURNAL ENTRY	000	1/78	436.27
302 00		000	1/78	561.50CR
302 00		000	1/78	440.00
302 00	JOURNAL ENTRY	000	1/78	210.00CR
302 00		000	1/78	310.00CR
303 00	PARTS	000	1/78	446.95CR
303 00		000	1/78	900.31CR
303 00	JOURNAL ENTRY	000	1/78	822.68
310 00		000	1/78	140.00CR
310 00		000	1/78	50.00CR
311 00	JOURNAL ENTRY	000	1/78	258.69

NAME: JOHN SMITH
 ADDRESS LINE 1: 23 MAIN
 ADDRESS LINE 2: DEXTER MO 63841
 PAY/PERIOD: 3/75
 SOC. SEC. #: 236-65-9710
 MARITAL STATUS SINGLE=0 MARRIED=1: 0
 EMPLOYING CLAIMED: 0
 PAY TYPE SALARY=RENT: X
 FREQ: 1-W 2-M 3-Q 4-Y: 3
 EMP # : 2
 PAYR. ACCT. #: 560

GROSS PAY: 330.00
 FICA TAX: 20.23
 FED. TAX: 47.82
 STATE TAX: 4.58
 MISC DED: 3.84
 REG RES: 88.00
 O.T. RES: 0.00
 NET PAY: 253.53

QTR-TOT GROSS PAY: 2370.00 2370.00
 QTR-TOT FICA TAX: 145.29 145.29
 QTR-TOT FED. TAX: 367.34 367.34
 QTR-TOT STATE TAX: 33.82 33.82
 QTR-TOT MISC DED: 04.36 04.36
 QTR-TOT REG RES: 828.09 828.09
 QTR-TOT O.T. RES: 0.00 0.00
 QTR-TOT NET PAY: 1759.19 1759.19

DISK PAYROLL computes FICA, Federal and State taxes. State tax is calculated on a percentage of the gross pay and can be customized for your particular state. Will allow use of City tax and/or other deductions. Utilizes printer for reports such as Payroll Register, which includes current payroll, quarterly and year-to-date figures and the Payroll Account Summary, which prints a department breakdown for cost accounting and gives a recommended tax deposit.

INTERNATIONAL ENTERPRISES INC.							
PAYROLL REGISTER							
FOR THE PERIOD ENDING 01/15/80							
EMP NO	REG	NAME	O.T.	GROSS PAY	FICA	FEDERAL STATE MISC	NET PAY
	REG		REG			DED	PAY
1		ANN SMALL		76.00	0.00	15.14 15.80 2.24	0.00 213.82
QTR				130.00	0.00	425.51 25.90 20.87	2.49 0.00 372.75
YTD				130.00	0.00	425.51 25.90 20.87	2.49 0.00 372.75
2		JOHN MILLER		41.50	0.00	145.25 8.90 13.15	.60 0.00 122.60
QTR				49.00	0.00	171.50 10.51 17.88	1.03 0.00 142.08
YTD				49.00	0.00	171.50 10.51 17.88	1.03 0.00 142.08

INTERNATIONAL ENTERPRISES INC.							
PAYROLL ACCOUNT SUMMARY							
FOR THE PERIOD ENDING 01/15/80							
ACCOUNT	REG	O.T.	GROSS	FICA	FEDERAL STATE	MISC	NET
	REG	REG	PAY			DED	PAY
100	41.50	0.00	600.25	36.79	56.80	6.84	0.00 499.82
550	32.00	0.00	152.60	9.32	7.80	1.34	0.00 133.94
555	164.00	0.00	555.00	34.02	50.75	4.93	0.00 465.30
560	231.50	0.00	832.25	51.02	104.74	8.73	3.84 663.92
575	85.50	0.00	299.25	18.34	41.36	3.74	3.84 231.97
			COMPANY TOTALS				
			\$94.50	0.00	\$268.75	146.49	261.45 25.58 7.68 1994.55
			RECOMMENDED TAX DEPOSIT		\$60.43		

PAYROLL SUMMARY			
	CURRENT	QUARTERLY	YTD
GROSS PAY	2438.75	16096.53	16096.53
FICA TAX	149.49	986.72	986.72
FED. TAX	261.45	1816.37	1816.37
STATE TAX	25.58	174.47	174.47
MISC DED.	7.68	188.39	188.39
REG RES	594.50	3618.50	3618.50
O.T. RES	0.00	0.00	0.00
NET PAY	1994.55	12930.58	12930.58
RECOMMENDED TAX DEPOSIT			\$60.43

THANKS FOR THE MEMORIES.

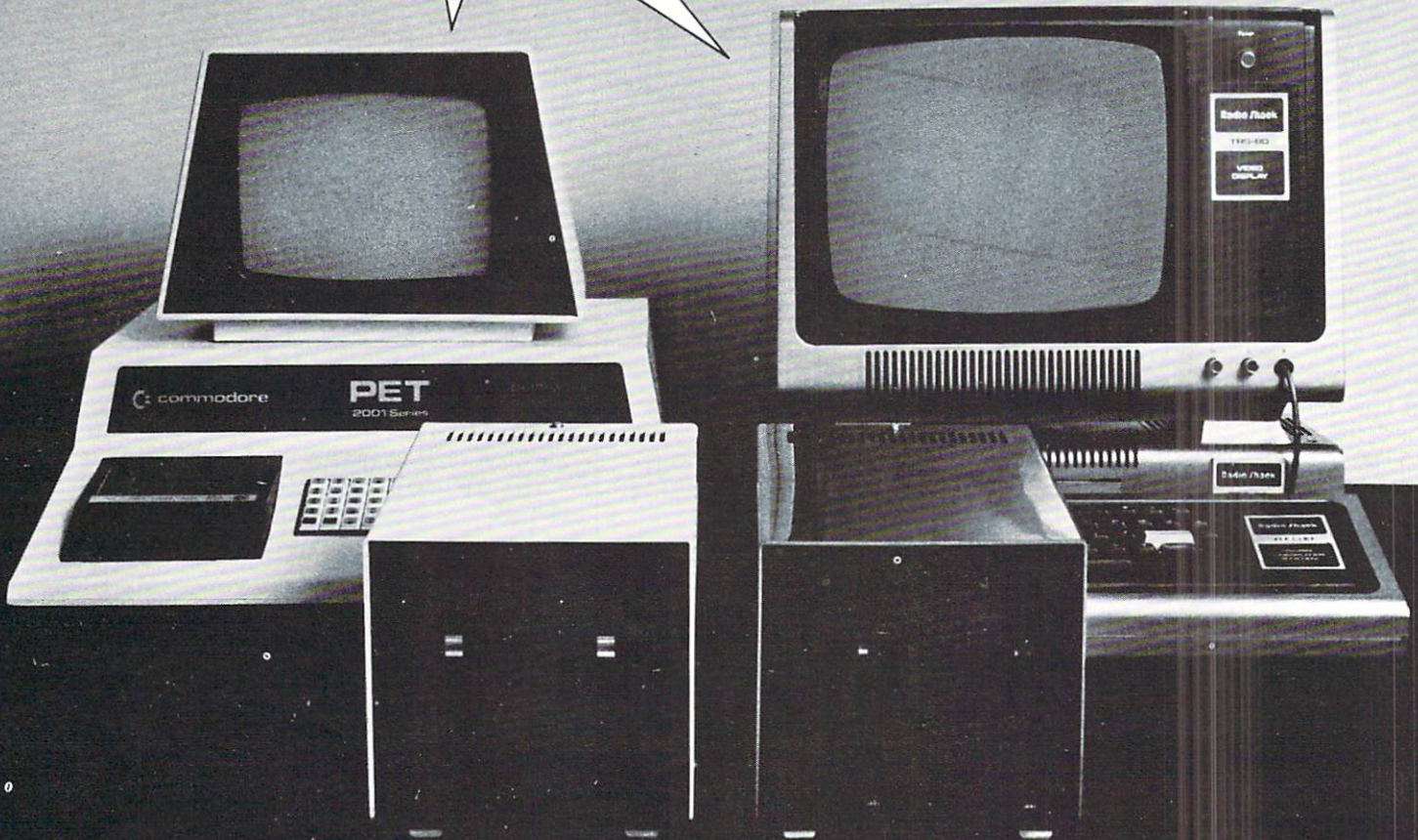

Thanks to these inexpensive Pet and TRS-80 memories and disk drives you can instantly increase your personal computer's capacity, capability and versatility.

Expand your Pet.

Disk Drives: Choose either double density 400k or dual head double density 800k on-line disk drive. Both with DOS operating system including 17 additional BASIC commands and random or indexed sequential access.

Exceptionally fast 5,000 bytes per second (including verify) transfer speed lets you load 20k program in just 3 seconds. Model 8k must have Expandamem™ to operate disk drives. All other models are plug compatible.

400k only \$1295. 800k only \$1695.

Expandamem™: Lets you expand the size and scope of your programs. 16k, 24k, and 32k internal memory boards give you 8k of assembly language subroutines accessed via the USR command.

16k only \$425. 24k only \$525. 32k only \$615.

Software: Complete library available. Write for details.

Expand your TRS-80.

Disk Drive: Single density dual head 400k on-line disk drive is completely compatible with TRS-80 DOS and uses own controller. Only \$1295.

IMMEDIATE DELIVERY! ORDER TODAY!

COMPUTHINK

965 W. Maude, Sunnyvale, CA 94086
(408) 245-4033

Please send me the following:

- Pet Disk Drive 400k 800k
- Pet Expandamem™ 16k 24k 32k
- Pet Software (Info only)
- TRS-80 400k Disk Drive
- Name of my nearest Computhink dealer

Total enclosed: \$ _____
Check or Money Order only Calif. Res. add 6% tax.
Freight pre-paid in continental U.S.
Dealer Inquiries Invited.

Name _____

Address _____

City _____ State _____ Zip _____

An Introduction to Small Business Software for the PET

An Overview of an Inventory and Mailing List Maintenance System.

It's about time! You've been seeing ads for small business software in just about every computer magazine published. With prices in the range of \$25 to thousands of dollars how does one decide just which system is the best to use. At best, a difficult choice—at worst, can bring on sleepless nights.

Now after long hours of thorough research and many months of programming, DR. DALEY's Software has come up with the first installment of a complete small business software system. However, it has some major disadvantages that you should consider before spending any of your hard earned cash—but more on that later.

DESIGN PHILOSOPHY

The first program is an inventory maintenance system. This is followed by a mailing list program. One of the first things learned in the research on an inventory program is that, despite the textbooks, virtually every small business operation has different requirements for its inventory information. This, of course, means that every business would either have to modify the packaged programs that it purchased, or hire its own consultant to write a custom program. It seems to us that either approach is unsatisfactory. The first would require considerable time and expertise, while the latter would be very expensive.

Another option is to write prepackaged software which each individual user can configure to his own needs. This would allow each business to customize its own computer maintained inventory files to, as closely as is possible, parallel the current inventory operation.

The approach selected for the design of the inventory system was to write a program which would allow the user to design, within reasonable limits, the configuration of the computer files and all operations on these files. This means that the user can computerize the business operations with less of the anguish that frequently accompanies this conversion.

After the design approach is selected, the task of coding the program is begun. The main thought in the coding process is to make the operation as easy and flexible as possible. Give the user the greatest conceivable number of useful operations and support these with various hard copy reports. Finally, be sure that the capacity of the system is sufficient to allow most any business to make use of it.

In summary, the operations of the inventory system will allow the user flexibility to design and maintain useful files which look like the files he already uses in his business. It will also allow reasonably large capacity with each of the 2010 records on a diskette having a total of 79 USABLE characters.

IMPLEMENTATION

The total operation of the system is "menu" driven with a number of "plain English" menu options. These options include adding records, editing them and saving them to the files. Also one can see, or edit individual records once they are placed on the disk. In addition one can zero a particular field on the disk for all records and calculate the value of the inventory for the entire inventory or for virtually any conceivable subset of the file. Finally one can obtain a listing of the entire file or almost any possible subset. For convenience a disk maintenance program is included which will allow you to copy files and to validate the integrity of the disk surface.

The one feature which sets this inventory system apart is the "Group search function" option. This option will allow the user to search through the files for virtually any set of the files that he might wish to find. The operation will allow the user to specify up to three fields within each record to be used for the search keys. Each search key uses a pattern matching search. That is, one must have an exact match for locations specified in the search key. However, the pattern must also match. Thus one can search through the file for a specific pattern within each of up to three fields for the record. One can specify patterns as follows:

**P*9Z

this matches with \$0P-9Z
and #/P29Z
and 16P:9Z

Thus one can select virtually any subset of the files by the appropriate selection of the search keys.

This does not really cover the entire operations on the files, but space simply does not allow the complete description of the system.

DISADVANTAGES

We warned you about this. This could easily discourage all but the most determined of you. Please consider these carefully before purchasing this product. Here they are:

1. You will have to do your own work in setting up the files. The programmer has not done this thinking for you. If you do

not spend some time thinking about this, you will find that some of the operations described above will not really be of much use to you.

2. The system is only available in the Commodore model 2040 disk format. If you don't own this powerful computer, then you won't be able to use this inventory system. If you have some other brand of computer please turn the page, otherwise read on.

3. The printer output is designed around the features of the CBM model 2022 printer. If you choose to use another printer, then you are on your own in modifying the printer output routines. The programmer made this somewhat easier in that the printer routines are all written as subroutines, thus changes in one location can cover most of the modifications necessary.

4. You probably will have to purchase this program by mail directly from the author. Most computer stores have not, as yet, responded to our calls for dealers.

5. At the present time this program is not interactive with any computer accounting system. This will make the cost control with the inventory only somewhat easier than doing this by hand. This should be remedied by midsummer of 1980.

ORDERING

Those of you who will accept these disadvantages and work around them will want to order a copy for your business. This can be done by either persuading your dealer to order it for you or calling us directly at the number given below. The price is \$99.95 plus 4 percent tax in the state of Michigan.

MAILING LIST

No we didn't forget this, but ran out of room. However, this program is much like the inventory system. One can have a total of 1340 names on a diskette with multiple diskettes in a file. The files are kept in sequence using any of the fields as a sort key. There is a practical limit with a 32K PET of about 125 diskettes. The user can design the appearance of the printer output. Almost any subset of the file can be printed. The price here is \$99.95.

Charge to
your
MC/VISA



DR. DALEY's Software
425 Grove Ave., Berrien Springs, MI 49103
Phone (616) 471-5514
Sun.-Thurs. noon to 9 p.m., Eastern Time

MACHINE LANGUAGE

Jim Butterfield

This column will discuss a number of topics related to the use of 6502 machine language. Practical coding examples will usually be for the PET/CBM.

The columns will not be in sequential style. They will not be a tutorial or "course" in machine language. Many of them will be written on an elementary level, however, and will be suitable for relative beginners. The emphasis will be on intuitive concepts rather than a rigorous definition of machine language.

Why Machine Language?

Basic programmers soon discover that their machines have an "inner code". Somewhere inside, there seems to be another language that is very fast, powerful and compact. Yet there seems to be no easy way to gain access to this feature: it's not easy to learn, and seems to be bound up with a special kind of machine jargon.

Basic people often stand in awe of the machine language "gurus". They might be surprised to find that many machine language programmers find Basic an intimidating language. Such people often find Basic to be complex, poorly defined, and riddled with obscure syntax rules. Many KIM, SYM and AIM owners are quite nervous when they first meet Basic - it's such a departure from the precise and (to them) simple machine language that they have learned.

Each language has its own advantages and disadvantages; neither is "better". Basic is particularly good for scientific and business calculations, especially where a program is changed frequently. Machine language is used where speed is vital; it tends to be used in mechanical environments, especially for hardware interfaces. Basic programmers tend to be data-oriented, and concentrate their efforts on getting information in and out. Machine language programmers like to work with the innards of the machine, and spend much of their time tinkering with the mechanics. There's room for both types of activity.

Let's compare Basic and Machine Language so as to get an idea where each has advantages. Nothing in the following list is absolute: sometimes Basic can be as fast as machine language; sometimes machine language can be as fast to code as Basic. But the comparisons are generally valid.

Basic is easier to write and get working.
You have a freedom to change a line, insert

new coding, and check out a program that can't be matched in Machine Language. Basic is easier to read. It's English-like syntax makes it relatively easy to pick up a program and see what it does. A dozen lines of Basic might require a hundred lines of machine language or more to do the same job.

Basic has splendid built-in capabilities. INPUT and PRINT are very powerful; in machine language you'd need to program the same capabilities the hard way. Other features, such as the way Basic handles variables, strings, and arrays call for a lot of machine language coding.

Basic usually uses less memory space. Surprise! Except for very small programs, machine language will gobble up more memory.

Machine language is fast. It's not uncommon for machine language programs to run ten or more times as fast as similar Basic programs. Keep in mind, of course, that input and output of data will be geared to the speed of the external device you are working with; machine language won't get input from the keyboard any faster than Basic.

Machine language can get at inner mechanisms that Basic can't reach.

Basic is much more portable between different machines.

So what do these comparisons tell us?

First, if Basic can do a job, and can do it fast enough, always use Basic. You'll write the program faster, and it will be easier to change in the future.

But if you have a speed problem, or if there's something you need to do that's beyond the capability of Basic, then use machine language. Remember that with machine language you will lose flexibility and portability. But if that's what you need to do the job, use it.

There are other reasons why it's good to know machine language. It gives you a glimpse of the inner secrets of your computer. Even Basic itself is just a huge machine language program stored in ROM. Each Basic statement is executed by dozens of tiny machine-language instructions which decide what is wanted and then perform the task. If you wanted to know precisely how a Basic statement worked, you would ultimately have to trace through the machine



Skyles Electric Works

Presenting the Skyles MacroTeA

The Software Development System For the Professional Programmer and The Serious Amateur Software Hobbyist

...and for anyone who needs to automate dedicated industrial measurement and control applications.

The Macro TeA, designed for use with the Commodore PET to create a remarkable synergism: a complete, integrated software development system for the 6502...the only 6502 system not requiring a separate disk drive. With over 60 commands for your complete machine language programming.

...a lightning fast...fast...fast
.....machine language assembler with true macro capabilities. Assemble 16K source text in less than ten seconds! A single name indentifies a whole body of lines. Macro and conditional assembly support. Automatic line numbering. Labels up to ten characters long; 10¹⁶ different labels.

```

ASSEMBLE LIST
0100 .MOVE TBL 1 TO TBL2
0110      BA $400
0400— A0 0B 0120 LOOP      LDY #00
0402— B9 0B 04 0130      LDA TBL1.Y
0405— 89 0B 05 0140      STA TBL2.Y
0408— C8      0150      INY
0409 D0 F7      0160      BNE LOOP
      0170
040B      0180 TBL1      DS 256
050B      0190 TBL2      DS 256
      0200
      0210      EN

LABEL FILE 1 = EXTERNAL
START = 0400      LOOP = 0402      TBL1 = 040B
TBL2 = 050B
110000,060B,060B

```

Install permanently without tools and in less time than it takes to load an equivalent sized assembler/text editor program from tape. No tape loading ever. And no occupying of RAM memory space: the MacroTeA puts 10K of executable machine language code in ROM (9800 to BFFF) and 2K in RAM (9000 to 97FF).

...a super powerful text editor. 26 commands with string search and replace capability. Manuscript feature. Test loading and storage on tape or disks. Supports tape drives, disks, CRT, printers and keyboard.

...an enhanced monitor with 11 powerful commands for program debugging and final polishing.

...with a warm-start button, on a 12 inch cable. Reset the PET but not the 1792 bytes of object code in the Macro TeA RAM memory.

...a completely solid state firmware system ...all in ROM and RAM. No tapes to load. The system is available from the time you turn on your PET to the time you shut it off.

15 chips on a single high quality printed circuit board; interfaces with PET's parallel address and data bus or with Skyles Memory Adapter. A comprehensive 170 page manual is included

Truly, there is simply no other system of this magnitude at anywhere near this price. **\$395.00***

(With any Skyles Memory Expansion System, \$375.00)

**California residents: please add 6% or 6.5% sales tax as required*

VISA, MASTERCHARGE ORDERS CALL (800) 538-3083 (except California residents)

CALIFORNIA ORDERS PLEASE CALL (408) 257-9140



Skyles Electric Works

231 E South Whisman Road
Mountain View, CA 94041
(408) 735-7891

language that did the job.

It's probably best to think of Basic and machine-language as complementary tools. You can and should use them together. Basic can call in a machine language program when it needs it by using a SYS command or a USR function. The machine language code can return to Basic when it's finished the job by using the RTS code. Data can be passed back and forth between the two languages.

The result: you can have the best of both worlds. The main part of your program will be in Basic so that you can code it quickly and easily. The tricky bits, where you need speed or special functions, will be in relatively short machine language programs.

Machine language is picky and exacting. It doesn't allow you many mistakes. If you're an impetuous programmer, you might be happier to stay with Basic, which is very lenient towards your mistakes. But if you're ready to take the time, and plot, scheme, plan, code, check, test and review - you can do some remarkable things with machine language.

It takes precision and patience. But there's nothing to compare with the rush you get when your machine language program finally works the way you planned it.

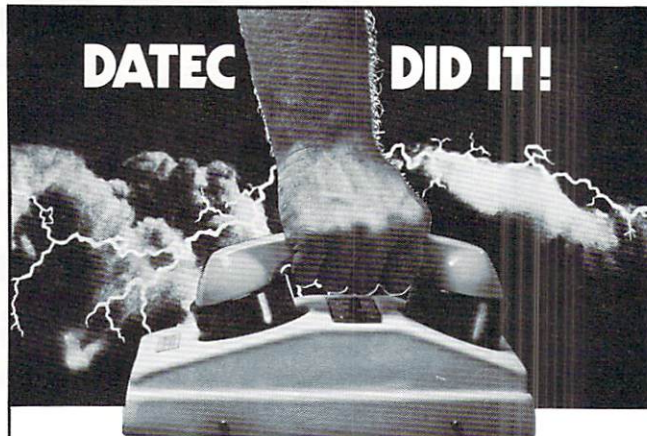

THE HEAVY DUTY COUPLER

Crystal control punches through rain-soaked, muddy lines to grab weakened signals.

Heavy duty rubber cups hold fast... knock out noise.

Torture testing boosts reliability above 99%. DATEC Heavy Duty couplers are guaranteed.

We're building our reputation on acoustic couplers. We've got to build them better.



DATECTM
Datec Incorporated
300 E. Main Street
Carrboro, N.C. 27510
(919)929-2135

DATEC 30 originate only. DATEC 32 originate and answer. Full or half duplex switchable. 0-300 BPS.



FREE! Up to \$170 in merchandise with purchase of one of following PET-CBM items !!!

Axiom EX-801 PET Printer (with graphics)	\$ 475.00
Axiom EX-820 PET Plotter	\$ 749.00
Anderson Jacobson 841 Selectric	\$1015.00
Leedex Video 100 12" Monitor	\$ 119.00
Heath WH19 Terminal (factory asm.)	\$ 770.00
Heath WH14 Printer (factory asm.)	\$ 735.00
IEEE-RS 232 Printer Adaptor for PET	\$ 88.00

BETSI PET to S-100 Interface	\$ 119.00
PET Connectors-Parallel or IEEE	\$ 1.95
Cassette Port	\$ 1.45
Hands on Basic with a PET	\$ 9.45
Programming the 6502 (Zaks)	\$ 9.45
6502 Applications Book (Zaks)	\$ 10.45
6500 Manuals (MOS Technology)	\$ 6.50
Programming a Microcomputer: 6502	\$ 8.45
6502 Assembly Language (Osborne) NEW!	\$ 8.10

PET SPECIALS

PET 16N 16K full size graphics keyboard	\$ 995	*FREE \$130
PET 16B 16K full size business keyboard	\$ 995	*FREE \$130
PET 32N 32K full size graphics keyboard	\$1295	*FREE \$170
PET 32B 32K full size business keyboard	\$1295	*FREE \$170
PET 8N 8K full size graphics keyboard	\$ 795	*FREE \$100
PET 2040 DUAL DISK DRIVE-343,000 bytes	\$1295	*FREE \$170
PET 2022 Tractor Feed Printer	\$ 795	*FREE \$100
PET 2023 Pressure Feed Printer	\$ 695	*FREE \$ 70
PET C2N External Cassette Deck	\$ 95	*FREE \$ 12
Used 8K PETs (limited quantities)	\$ 495	

*Amount of Free Merchandise with Purchase of PET-CBM Item.

KIM-1 \$159 (add \$30 for power supply)	SYM-1 \$209
BAS-1 Microsoft ROM Basic for SYM	\$ 85
Memory Plus (KIM, SYM, AIM)	\$195
SYM Assembler in ROM	\$ 85
SEA-16 New 16K Static RAM	\$325
Seawell Motherboard - 4K RAM Space	\$139
KTM-2/80 Synertek Video Board	\$349
S-100 16K Static RAM Kit	SALE \$219
TIS PET Workbooks - set of 6	\$ 21.50
Dust Cover for PET	\$ 8.90

All Book and Software Prices are Discounted

PET Personal Computer Guide (Osborne)	\$ 12.75
PET and the IEEE-488 Bus (Osborne)	\$ 12.75
6502 Software Cookbook (Scelbi)	\$ 9.45
Cassettes (all tapes guaranteed) AGFA PE611	Premium quality, high out put lownoise in 5 screw housing with labels:
C-10	10/5.65 50/25.00 100/48.00
C-30	10/6.90 50/30.00 100/57.00

2716 EPROM (5 volt)	\$ 29.00
6550 RAM (for 8K PET)	\$ 12.70
6502 \$9.75	6522 \$9.00 6520 \$5.50
2114 L 450 ns \$5.35	24@ \$4.95 100 @ \$4.45

ATARI - INTRODUCTORY SPECIAL

ATARI 400, Atari 800 and all Atari Modules 20% OFF.

Programmers Toolkit - PET ROM Utilities	\$ 44.90
Sargon II (TRS-80 or Apple) NEW!	\$ 24.90
Microchess for PET (Peter Jennings)	\$ 17.90
Visible Music Monitor (4 Voice) for PET	\$ 29.90
KL-4M 4 Voice Music Board (PET)	\$ 34.90
CmC Word Processor (8K \$25) (16K \$34)	
Adventures by Scott Adams	15% Off



SALE

3M "Scotch" 8" Disks	10/\$31.00
3M "Scotch" 5" diskettes	10/\$31.50
Verbatim 5" diskettes	10/\$26.50
Diskette Storage Pages	10/\$ 3.95
Disk Storage Boxes 8" \$2.85 5 1/4" \$1.95	(Write for quantity prices)



MINIMAX by COMPU/THINK

MINIMAX I (8 Megabyte Disks) **\$4495**
MINIMAX II (2.4 Megabyte Disks) **\$5995**

SPECIAL - MINIMAX prices include Compu/Think PAGEMATE Database and Report Writer at no charge.

The most advanced complete microcomputer system available.

Includes CPU, 12" CRT, Full Keyboard, 2 Quad-Density Disk Drives, 2 Megahertz 6502 Hybrid Processor (double speed), 108 K System Memory, High Resolution (512 x 240) Graphics, Programmable Character Fonts, Microsoft Extended BASIC, DOS with Random Access I/O, Full Complement of I/O Ports, Monitor with Debug, Trace, and Tiny Assembler, Fifth (PL/M and Forth combination) Interpreter, Complete editing and entry with split screen capability, 64 Microprogrammable Opcodes, Business software (with Database) available.

115 E. Stump Road
Montgomeryville, PA 18936

(215) 699-8386
699-5826

A B Computers

WRITE FOR COMPLETE CATALOG

Add \$1.00 per order for shipping.
We pay balance of UPS surface charges on all prepaid orders.

Review:

SYNERTEK SYSTEMS KTM-2

Synertek Systems Corporation
150 S. Wolfe Road
Sunnyvale, CA 94086

Reviewed by Edward D. James
7207 Sherbourne Dr.
Charlotte, NC 28210

With interactive data processing becoming increasingly important, the CRT terminal has carved quite a niche for itself. Advances in technology have brought the cost of a CRT terminal down to the point that it is now feasible to incorporate such a device in a small system either in a business or industrial environment or even in a home computer system. Microprocessors have helped to make the CRT locally intelligent and highly versatile.

The SYNERTEK KTM-2 is a recently introduced CRT module which provides a medium performance CRT terminal when coupled with a 5 volt d.c. power supply and a video monitor. It is produced in a 24 line by 40 character display model, the KTM-2, and a 24 line by 80 character display model, the KTM-2/80.

In preparation for this review, both models were tested but emphasis was put on the KTM-2/80. The test system incorporated an IMSAI 8080 micro-computer system running under the CP/M Operating System and a Motorola microprocessor power supply.

The KTM-2/80 was unpacked immediately upon receipt and inspected for damage. The unit was well packed and none was found. The manual for the unit was thoroughly read before power-on testing. Though brief, the manual is concise and provides adequate information for the use and software implementation of the KTM-2/80. Recognizing that most users are anxious to be "on-line", the necessary information to power-on the unit and put it on-line is given early in the manual.

All needed connectors are provided for the power input, RS-232c main port, and the auxiliary port. Both I/O ports use standard DB-25 connectors. The factory configuration of the board is for 5 volt signal levels on the I/O ports in order that the KTM-2/80 may be run on a single power supply. If full + and - 12 volt signal levels are desired, the user must also supply a +12 volt supply, a -12 volt supply and a 1488 interface integrated circuit for which a dip socket is provided. A 75-ohm coaxial cable from the provided RCA Phono type plug to a user supplied video monitor completes the installation. The KTM-2 may be used with an ordinary black and

white T.V. set, but the KTM-2/80 requires a greater bandwidth and *must* be used with a high resolution video monitor.

No problems were encountered with either unit tested. Both units powered-on right out of the box with absolutely no difficulty. The user must select the proper baud rate, (110 thru 9600 baud,) parity, and 50/60 hertz sweep sync, and the terminal is on-line.

There is no LOCAL mode but the transmitted signal from the KTM-2 may be wrapped around at the main port connector back into the received data line. This allows the user to type on the KTM-2 keyboard and observe the text on the video monitor without a connection to a host system.

The KTM family has a graphics mode which has a set of 64 different special graphics characters. It also has absolute cursor addressing, reverse video, and CONTROL and ESCAPE sequences which allow cursor control, some limited screen editing, a KTM-2 software reset, clear screen, and auxiliary port control. All communications are full duplex. Characters typed on the KTM are displayed only if the host system software reflects the transmitted data back to the terminal. The KTM will simultaneously transmit and display independent data.

TECHNICAL

The KTM-2/80 is a well designed unit incorporating all electronics and the keyboard all on a single 7 by 16 inch printed circuit board. At the time of this writing, an enclosure is not available but the author has received word that one is forthcoming. A number of mounting holes are provided in the p.c. board allowing for an assortment of mounting configurations. A mechanical drawing is provided in the manual that details the necessary dimensions to allow a user to fabricate his own enclosure or panel mounting.

The unit employs the 6502 microprocessor to handle communications and data manipulation. Type 2114 ram chips are used for screen memory. The KTM-2 has 1K of ram while the KTM-2/80 has 2K of ram. Character generation and the 6502 software are resident in on-board ROM. (Synertek

MICROCOMPUTER MEASUREMENT and

Analog Input Module



The AIM 16 is a 16 channel analog to digital converter designed to work with most microcomputers. The AIM16 is connected to the host computer through the computer's 8 bit input port and 8 bit output port, or through one of the uMAC SYSTEMS special interfaces.

The input voltage range is 0 to 5.12 volts. The input voltage is converted to a count between 0 and 255 (00 and FF hex). Resolution is 20 millivolts per count. Accuracy is 0.5% ± 1 bit. Conversion time is less than 100 microseconds per channel. All 16 channels can be scanned in less than 1.5 milliseconds.

Power requirements are 12 volts DC at 60 ma.

The POW1 is the power module for the AIM16. One POW1 supplies enough power for one AIM16, one MANMOD1, sixteen sensors, one XPANDR1 and one computer interface. The POW1 comes in an American version (POW1a) for 110 VAC and in a European version (POW1e) for 230 VAC.

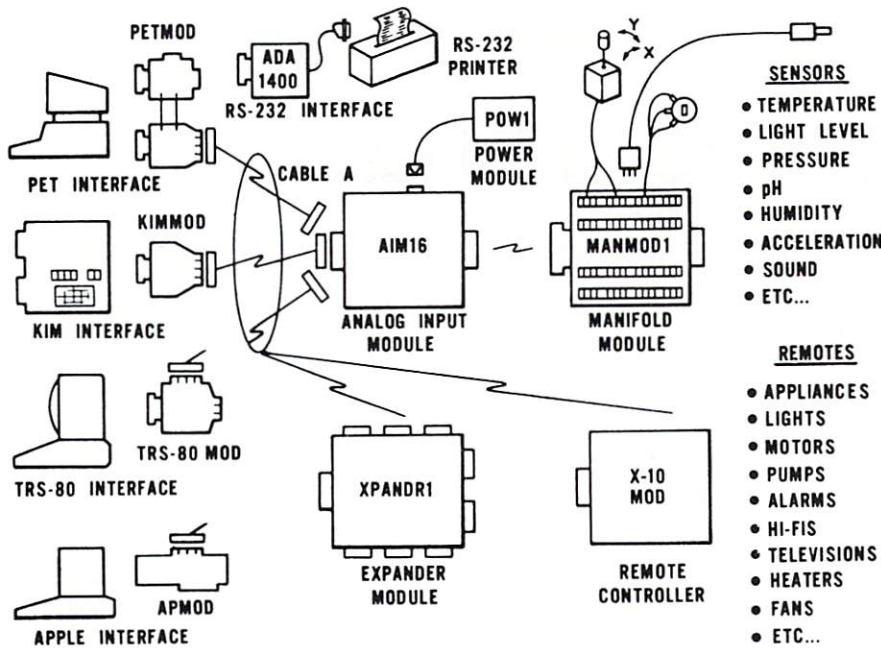

- SENSORS**
- TEMPERATURE
 - LIGHT LEVEL
 - PRESSURE
 - pH
 - HUMIDITY
 - ACCELERATION
 - SOUND
 - ETC...

- REMOTES**
- APPLIANCES
 - LIGHTS
 - MOTORS
 - PUMPS
 - ALARMS
 - HI-FIS
 - TELEVISIONS
 - HEATERS
 - FANS
 - ETC...

The world we live in is full of variables we want to measure. These include weight, temperature, pressure, humidity, speed and fluid level. These variables are continuous and their values may be represented by a voltage. This voltage is the analog of the physical variable. A device which converts a physical, mechanical or chemical quantity to a voltage is called a sensor.

Computers do not understand voltages: They understand bits. Bits are digital signals. A device which converts voltages to bits is an analog-to-digital converter.

Our AIM 16 (Analog Input Module) is a 16 input analog-to-digital converter.

The goal of Connecticut microComputer in designing the uMAC SYSTEMS is to produce easy to use, low cost data acquisition and control modules for small computers. These acquisition and control modules will include digital input sensing (e.g. switches), analog input sensing (e.g. temperature, humidity), digital output control (e.g. lamps, motors, alarms), and analog output control (e.g. X-Y plotters, or oscilloscopes).

TEMPSENS

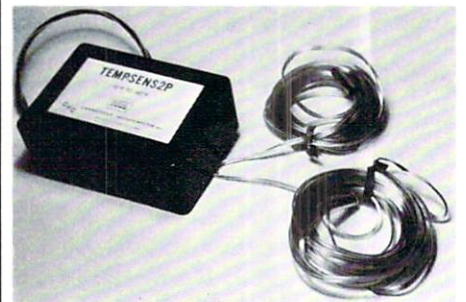

This module provides two temperature probes for use by the AIM16. This module should be used with the MANMOD1 for ease of hookup. The MANMOD1 will support up to 16 probes (eight TEMPSENS modules).

Resolution for each probe is 1°F.

Connectors

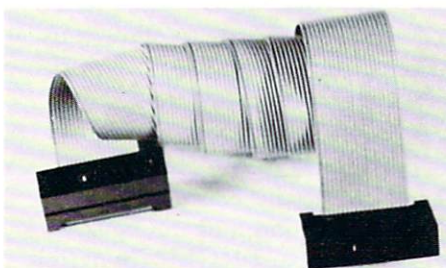
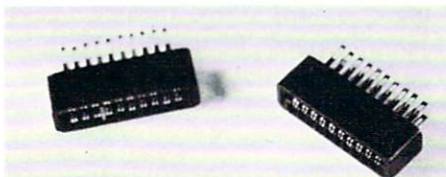
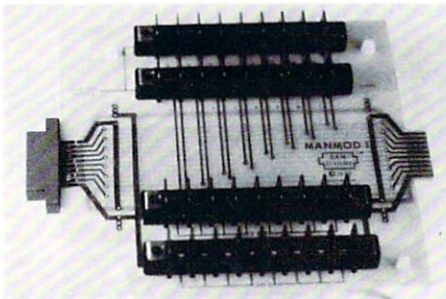

The AIM 16 requires connections to its input port (analog inputs) and its output port (computer interface). The ICON (Input CONnector) is a 20 pin, solder eyelet, edge connector for connecting inputs to each of the AIM16's 16 channels. The OCON (Output CONnector) is a 20 pin, solder eyelet edge connector for connecting the computer's input and output ports to the AIM16.

The MANMOD1 (MANifold MODule) replaces the ICON. It has screw terminals and barrier strips for all 16 inputs for connecting pots, joysticks, voltage sources, etc.

CABLE A24 (24 inch interconnect cable) has an interface connector on one end and an OCON equivalent on the other. This cable provides connections between the uMACSYSTEMS computer interfaces and the AIM 16 or XPANDR1 and between the XPANDR1 and up to eight AIM 16s.

XPANDR1

The XPANDR1 allows up to eight Input/Output modules to be connected to a computer at one time. The XPANDR1 is connected to the computer in place of the AIM16. Up to eight AIM16 modules are then connected to each of the eight ports provided using a CABLE A24 for each module. Power for the XPANDR1 is derived from the AIM16 connected to the first port.

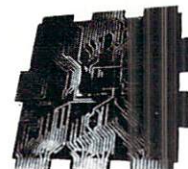

CONTROL for PET, Apple, KIM, and AIM



Computer Interfaces and Sets

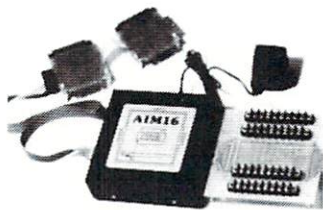

For your convenience the AIM16 comes as part of a number of sets. The minimum configuration for a usable system is the AIM16, one POW1, one ICON and one OCON. The AIM16 Starter Set 2 includes a MANMOD1 in place of the ICON. Both of these sets require that you have a hardware knowledge of your computer and of computer interfacing.

For simple plug compatible systems we also offer computer interfaces and sets for several home computers.

INTRODUCING
SUPER X-10 MODULE
Open a door or window and turn on a light, tape recorder, alarm!

Control lab equipment. CLOSE THE LOOP on the real world.

AN INEXPENSIVE CONTROL SOLUTION FOR

- HOME SECURITY
- ENERGY CONSERVATION
- GREENHOUSES
- ENVIRONMENTAL CONTROL
- INDUSTRIAL CONTROL
- LABORATORIES

SUPER X-10 MOD SPECS

1. Remote controller
Controls up to 256 different remote devices by sending signals over the house wiring to remote modules. Uses BSR remote modules available all over the USA (Sears, Radio Shack, etc.). Does not require BSR control module. Does not use sonic link.
2. Clock/calendar
Time of day - hours, minutes, seconds
Date - month, day - automatically corrects for 28,29,30 and 31 day months.
Day of the week.
3. Digital inputs/outputs
8 inputs - TTL levels or switch closures.
Can be used as triggers for stored sequences.
8 outputs - TTL levels
4. Computer interfaces
S-100: Requires one 8-bit input port and one 8-bit output port.
Requires cable assembly.
PET, APPLE, TRS-80, KIM, SYM, AIM65: Plug-in sets available - no cable assembly required.
Other: same as S-100
5. Self-contained module in metal case with its own power supply. Physical size approximately 5X6X2.



PLUS:
CLOCK, CALENDAR,
REMOTE SEQUENCE TRIGGERS

Price (until April 30, 1980): \$199.00 (S-100), \$249.00 (other)

All prices and specifications subject to change without notice. Our 30-day money back guarantee applies.

AIM16 (16 channel-8 bit Analog Input Module)	179.00
POW1a (POWer module-110 VAC)	14.95
POW1e (POWer module-230 VAC)	24.95
ICON (Input CONNector)	9.95
OCON (Output CONNector)	9.95
MANMOD1 (MANifold MODule)	59.95
CABLE A24 (24 inch interconnect cable)	19.95
XPANDR1 (allows up to 8 Input or Output modules to be connected to a computer at one time)	59.95
TEMPSENS2P1 (two temperature probes, -10°F to 160°F)	49.95
LIGHTSENS1P1 (light level probe)	59.95

The following sets include one AIM16, one POW1, one OCON and one ICON.
AIM16 Starter Set 1a (110 VAC) 189.00
AIM16 Starter Set 1e (230 VAC) 199.00

The following sets include one AIM16, one POW1, one OCON and one MANMOD1.
AIM16 Starter Set 2a (110 VAC) 239.00
AIM16 Starter Set 2e (230 VAC) 249.00

The following modules plug into their respective computers and, when used with a CABLE A24, eliminate the need for custom wiring of the computer interface.

PETMOD (Commodore PET)	49.95
KIMMOD (KIM, SYM, AIM65)	39.95
APMOD (APPLE II)	59.95
TRS-80 MOD (Radio Shack TRS-80)	59.95

Order Form

CONNECTICUT microCOMPUTER, Inc.
150 POCONO ROAD
BROOKFIELD, CONNECTICUT 06804
TEL: (203) 775-9659 TWX: 710-456-0052

The following sets include one AIM16, one POW1, one MANMOD1, one CABLE A24 and one computer interface module

PETSET1a (Commodore PET - 110 VAC)	295.00
PETSET1e (Commodore PET - 230 VAC)	305.00
KIMSET1a (KIM, SYM, AIM65 - 110 VAC)	285.00
KIMSET1e (KIM, SYM, AIM65 - 230 VAC)	295.00
APSET1a (APPLE II - 110 VAC)	295.00
APSET1e (APPLE II - 230 VAC)	305.00
TRS-80 SET1a (Radio Shack TRS-80 - 110 VAC)	295.00
TRS-80 SET1e (Radio Shack TRS-80 - 230 VAC)	305.00

QUANTITY	DESCRIPTION	PRICE	TOTAL
SUBTOTAL			
Handling and shipping — add per order			\$3.00
Foreign orders add 10% for AIR postage			
add 7% sales tax			
TOTAL ENCLOSED			

NAME _____
 COMPANY _____
 ADDRESS _____
 CITY _____
 STATE _____ ZIP _____
 VISA M/C Expiration date _____
 Card number _____

has a division which manufactures the micro-processor and memory components used in the KTM-2.) The microprocessor approach allows a minimum components count and greater reliability in a total package requiring only 1.3 amps at +2 volts. (1.1 amps for the KTM-2.) The layout of the unit is clean and open on a double-sided glass-epoxy p.c. board. An on-board LED indicates the UCA, upper-case alpha mode and an 8-position DIP switch provides for hardware function selection. The units evaluated were well assembled and of excellent quality.

CONCLUSION

Both the KTM-2 and the KTM-2/80 are well designed, well built units capable of use in a commercial application or in personal computing. Quality is excellent and a standard 90-day warranty covers parts and labor. Unit delivery is from stock at most dealers or from the factory.

The KTM-2 series of CRT modules have a great potential in mid-range or semi-intelligent terminal applications. The design is such that only the designer's imagination is the limit for applications. At the time of this writing, retail price on these units is \$349.00 for the KTM-2 and \$424.00 for the KTM-2/80. By the time the user adds a power supply and monitor, the investment approaches \$625.00. The KTM-2 is not inexpensive, but is an excellent CRT terminal. ©

XYMEC (17791 Skypark Circle "H", Irvine, CA 92714) has announced their new "Intelligent Printer": the HY-Q 1000™.

According to XYMEC, the HY-Q 1000--a low-cost, letter-quality daisy wheel printer with five built in microprocessors--eliminates the need for complex personal computer software. The HY-Q 1000 will automatically convert simple codes into instructions for right justification, proportional spacing, automatic tabbing, bold and underlined letters, automatic columns, automatic title centering, automatic decimal point location, and other commonly-used text formatting functions.

The HY-Q 1000 has many other features, including "QUADRA-PITCH"™ (10, 12, or 15 characters per inch, or proportional spacing); up to 198 characters per line; 100 printable characters in five languages (English, Italian, Spanish, French, and German, available without changing the daisy wheel); and a choice of 21 different typestyles in five different colors. Another unique feature is "reverse printing"--white characters on a black background.

The HY-Q 1000 can also function as a highly versatile, sophisticated electronic typewriter. The typewriter, made by the Olivetti Corporation, also

provides a 224 character, two-line memory (allowing a typist to correct any character in the last two lines in seconds); a 1024-character, non-volatile memory for often-used phrases, margins, and tabs; automatic paper positioning; electronic margin reset; and a digital readout to show column position and lines to end of page.

XYMEC's HY-Q 1000 intelligent printer is priced at \$2495 retail. It is now available at leading computer stores nationwide or directly from the factory in Irvine, California. Delivery is 60 days. OEM and computer dealer discounts are also available.

The HY-Q 1000 comes with a 3 month warranty. Maintenance is available at over 500 Olivetti Service Centers and dealers around the United States.

XYMEC is a subsidiary of Litronic Industries, a leading electronics subassembly manufacturing company. ©

Instant Software Adds Diskettes

PETERBOROUGH, NH - Instant Software Inc. has just released its catalog of computer software for the spring of 1980.

This catalog lists over 200 programs for the TRS-80, PET, Apple II and Heath H-8 micro-computers -- and features the announcement of Phase II Software, available on floppy disc!

These software packages cover a broad range of subjects, from business and education to entertainment and home management. Accompanying each catalog item is a description of the package contents and specifications for systems, memory, and -- where applicable -- other required software.

Those who desire a copy of this catalog should inquire at their local computer store, or write: Instant Software Inc., Catalog Dept., Peterborough, NH 03458. ©



16K MEMORY

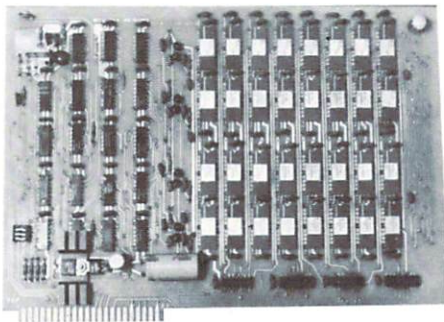

K-1016

- ADDRESSED AS CONTIGUOUS 16K STARTING AT ANY 8K BOUNDARY
- LOW POWER — 1.6 WATTS TOTAL
- K-1016A — \$340 6 MONTH WARRANTY

SYSTEM EXPANSION

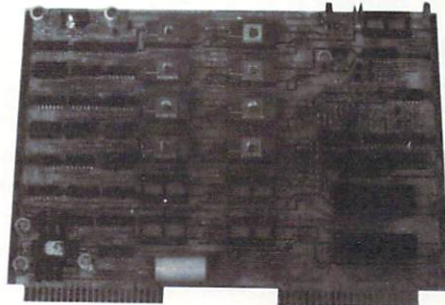

K-1012

- 12 PROM SOCKETS — 2708/TMS 2716, USES THE POWER OF ONLY 1 PROM.
- 32 BIDIRECTIONAL I/O LINES
- FULL RS-232 ASYNC SERIAL COMMUNICATIONS, 75-4800 BAUD
- PROM PROGRAMMER
- K-1012A — \$295

EXPANSION FOR YOUR 6502 COMPUTER

HIGH RESOLUTION GRAPHICS

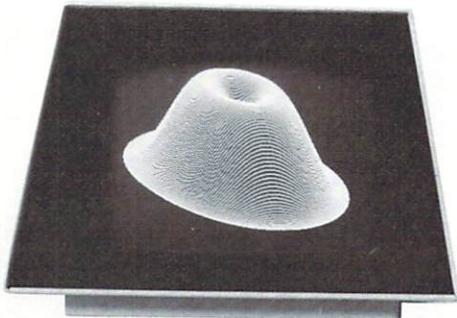

- 320 x 200 BIT MAPPED GRAPHICS
- 8K RAM AVAILABLE FOR USE
- EACH POINT INDIVIDUALLY ADDRESSABLE
- K-1008A — \$240, PET — \$243 (PLUS PET INTERFACE)

MULTI-HARMONIC 4 VOICE MUSIC

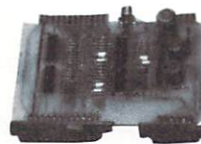

K-1002-2

MODEL FOR ALL PETS



K-1002

MODEL FOR KIM, AIM, SYM

- FORIER SYNTHESIZED WAVEFORMS — UP TO 16 HARMONICS
- 4 VOICES PLAY SIMULTANEOUSLY
- QUALITY D/A CONVERTER, 6 POLE FILTER AND AMPLIFIER
- HARDWARE — \$40-50, SOFTWARE — \$20



ALL MTU PRODUCTS ARE SUPPLIED WITH FULL DOCUMENTATION CLASSIFIED AS "BEST IN THE INDUSTRY". MANUALS MAY BE PURCHASED SEPARATELY.

MTU
Micro Technology Unlimited

P.O. Box 4596, 841 Galaxy Way
Manchester, N.H. 03108
603-627-1464

Call Or Write For Our Full Line Catalog

UTINSEL: ENABLING UTILITIES

Larry Isaacs

There is a growing amount of good utility software which can make the time spent with our PETs more productive. Some of these utilities add themselves to the operating system of the PET, providing us with extra commands, debugging tools, etc. It was my desire to have a number of these in memory at the same time and be able to access them as needed. To do this, there were a couple of problems to be dealt with.

The first problem comes from the way these utilities attach themselves to the operating system. When enabled, usually via a SYS command, they attach themselves to the operating system by modifying the CHARGOT routine found in page zero. The operating system uses this routine to fetch characters from a program while it is running, or from the keyboard buffer when executing immediate commands. By modifying the CHARGOT routine, the utility can examine the input before the operating system does. When using various utilities, it's possible for one utility's modifications to be incompatible with another's.

So far the only difficulty I've encountered involving the CHARGOT routine is with Commodore's DOS Support Program, also known as the WEDGE. The WEDGE requires a machine language jump instruction in the first three bytes of the CHARGOT routine. This jump instruction should jump to the starting point in the WEDGE machine code. Unfortunately, the WEDGE is not able to put this jump instruction into the CHARGOT routine. It is put there by some extra machine code which is part of the DOS Support Program on diskette. This means I don't have a SYS command to enable the WEDGE. If I enable another utility which modifies the first three bytes of the CHARGOT routine, it would take some extra work to re-enable the WEDGE.

The second problem is simply all those SYS commands you have to remember. The following program, called UTINSEL, provides a simple and flexible solution to the above problems. With it, you only need to remember a couple of SYS commands.

UTINSEL consists of a menu table and a machine language program, which is executed via a SYS command. The menu table is user definable, and can contain up to nine entries. Each entry consists of

a prompt message plus a copy of the CHARGOT routine that enables the associated utility or utilities. When executed, the machine language program lists the prompt messages, preceding each with a number. By typing the number of the menu item you want plus a carriage return, the associated CHARGOT routine will be copied into the proper location in page zero.

The UTINSEL/NEW program includes the machine code and menu table in data statements, plus a BASIC program which pokes the code and table into the top of free memory. To adapt UTINSEL/NEW to your own requirements, you need only modify the menu table.

To set up your own utility package, first reset your PET. Next, load in the utilities which occupy RAM. Now run a version of UTINSEL with only the ORIGINAL menu entry provided in the listing. To determine what CHARGOT routines you will need for your menu table, write a short program to print out 24 memory locations starting at 112 for new PETs and 194 for old PETs. Now you may enable the desired utility and then run your program to print out the required CHARGOT routine. Before enabling other utilities, restore the original CHARGOT routine by executing the UTINSEL program you loaded earlier. In some cases it is possible to enable more

Model EP-2A-79 EPROM Programmer

PET • APPLE • AIM-65 • KIM-1 • SYM-1 • OHIO SCIENTIFIC



Software available for F-8, 6800, 8085, 8080, Z-80, 6502, 1802, 2650, 6809, 8086 based systems.

EPROM type is selected by a personality module which plugs into the front of the programmer. Power requirements are 115 VAC 50/60 Hz. at 15 watts. It is supplied with a 36-inch ribbon cable for connecting to microcomputer. Requires 1½ I/O ports. Priced at \$155 with one set of software. (Additional software on disk and cassette for various systems.) Personality modules are shown below.

Part No.	Programs	Price
PM-0	TMS 2708	\$15.00
PM-1	2704, 2708	15.00
PM-2	2732	30.00
PM-3	TMS 2716	15.00
PM-4	TMS 2532	30.00
PM-5	TMS 2516, 2716, 2758	15.00
PM-8	MCM68764	33.00

Optimal Technology, Inc.
Blue Wood 127, Earlysville, Virginia 22936
Phone (804) 973-5482

NEED MORE ROM ROOM?

The Spacemaker

\$27.00

Now a Product of CGRS Microtech

The Spacemaker family provides expansion ROM capability for owners of new Commodore PETs and CBMs.

The Spacemakers' Present:

Switch Between Your Toolkit and Word Pro II ROM
Add the Computhink Option and switch between
your Toolkit and Computhinks new ROM DOS

Dealers as of February, 1980

A B Computers
115 E. Stump Rd.
Montgomeryville, PA 18936
Active Business Machines
23 Beta Court
San Ramon, CA 94583
415-837-4421
ACT/Petsoft
Radcliffe House
66-68 Hagley Rd.
Edgbaston, Birmingham
England B16 8PF
American Peripherals
3 Bangor St.
Lindenhurst, N.Y. 11757
516-226-0552
Bits & Bytes
2800 Straight Rd.
Fredonia, NY 14063
716-673-1682
Computer Center of South Bend
51591 US 31 North
South Bend, IN 46637
Computer Factory, Inc.
485 Lexington Ave.
New York, NY 10017
212-687-5001
Computer Innovations, Ltd.
171 Slater St.
Ottawa, Ontario
Canada K1P 5H7
Computer Nook
Rt. 46 Pinebrook Plaza
Pinebrook, NJ 07058
201-575-9468
Computer Specialties
3820 Minton Rd.
Melbourne, FL 32901
305-724-7314
Computer Systems & Software
Bland Office Bldg.
928 N. York - Suite 19
Muskogee, Okla. 74401
918-687-3161
Computershop janal
#12 coursHerbouville
Lyon, France 69004
Conti Electronics
5656 Fraser
Vancouver, British Columbia
Canada V5W 2Z4
Data Equipment Supply
8315 Firestone Blvd.
Downey, CA 90241
213-923-9361

Dialog Computer
5003 Rick Dr.
Santa Rosa, CA 95405
707-538-0643
Future Distribution, Inc.
Trimex Bldg., Rt. 11
Moers, NY 12958
The HI-FI Shop
4680 Holladay Blvd.
Salt Lake City, Utah 84117
801-277-2629
Home Computers
1775 E. Tropicana Unit 2
Las Vegas, Nevada 89109
702-736-6363
K-Smith Associates
11 Mast Court
Sacramento, CA 95831
MBC Systems
28 Marlboro St.
Portland, CT 06480
Melad Associates
1 Perry Rd.
E. Brunswick, NJ 08816
201-828-3682
Micro Mini Computer World
74 Robinwood Ave.
Columbus, OH 43213
MiniComp Systems Ltd.
5666 Stanley St.
Halifax, Nova Scotia
Canada B3K 2G1
Mr. Calculator
160 E. El Camino Real
Mt. View, CA 94040
NCE/Compumart
270 Third St.
Cambridge, MA 02142
New England Electronics Co.
679 Highland Ave.
Needham, MA
Orlando Electronic Co.
2356 W. Oak Ridge Rd.
Orlando, FL 32809
PC Computers
10166 San Pablo Ave.
El Cerrito, Ca 94530
415-527-6657
Programmable Electronic Calculators,
Ltd.
1746-48 W. Chapman
Orange, CA 92668
714-978-6587
Television Elect. Dist.
P.O. Box 10525
Johannesburg 2000 South Africa
Tysons Computer Emporium
1984 Chain Bridge Rd.
McLean, VA 22101
703-821-8333

The Spacemakers' Future:

While it looks as if Commodore's Word Pro III ROM may move to \$A000 (thus avoiding the conflict with the current version of the Toolkit), three U.S. software vendors (that we know of) are currently working on ROM based software packages. Look out conflicts!

Start with Spacemaker as your ROM switching device, and it can grow as your problems do. Spacemaker and its family of optional devices allow you to:

Select one of two ROMs at the same address space...

Use two Spacemakers to select one of each of two pairs of ROMs at adjoining address spaces... (Spacemaker is designed vertically, so you can plug them into empty sockets, side by side!)

Add our software control option and you can Daisy-chain Spacemakers together (with simple little jumpers- the pins you plug into are already built into every Spacemaker) and you can switch select between one of four ROMs at the same address space.

Daisy-chain more and keep selecting...

Don't get left behind in the ROM Race. Spacemaker can grow as your switching problems do. Visit your local dealer to get the full story.

**MICROTECH,
the PEDISK Company.**

**P.O. Box 102
Langhorne, PA 19047
215-757-0284**

PET is a trademark of Commodore Business Machines
Spacemaker (formerly a product of Small System
Services, Inc.) is a trademark of CGRS Microtech.
The BASIC Programmer's Toolkit is a trademark of
Palo Alto ICs.

than one utility. For example, The BASIC Programmer's Toolkit and the WEDGE can be enabled simultaneously.

To set up the menu table, you must include a set of DATA statements for each utility. The next DATA statement of a set should contain a prompt message. The next DATA statements should contain the CHARGOT routine needed by the utility, or utilities, associated with the prompt message. These sets of statements may be placed in the menu table in any order. After you've entered the menu table, set N in the program to the number of entries.

Now save a copy of the program with your table; then run it. The machine code and table will be loaded into memory just below your utilities. Write down the two SYS commands it prints out. The first one sets the top of memory pointer to just below UTINSEL, and the other executes the UTINSEL machine code. To save your utility package, enter the machine language monitor and examine the top of memory pointer at hex 34 and 35. If you haven't done this before, type SYS1024 and M 0034 0035 to get a hex dump of these locations. Use these values to save memory from this starting address up to the physical top of memory. Refer to the Commodore manual for more detail on the save command. For the program listing provided, hex 34 and 35 were 47 and 7D respectively, and the save command was S "UTILITY.PKG",08,7d47,8000 for saving on Commodore disk using a 32K CBM. Whenever you load in your utility package, be sure to use the SYS command to get the top of free memory before running any programs.

The listing provided is for UTINSEL/NEW, which runs on new ROMs. The menu table includes entries for The BASIC Programmer's Toolkit, the Commodore DOS Support program, and the original CHARGOT routine. You may also want to include the TRACE utility by Brett Butler in the Fall COMPUTE. The second listing gives the changes needed to convert the program to UTINSEL/OLD for original ROMs. When printing the CHARGOT routine, start at 194 instead of 112. You will have to have a machine language monitor on tape if you wish to save the machine code on the original ROMs.

```
100 REM UTINSEL/NEW
110 REM UTILITY INPUT ROUTINE SELECTOR
120 PRINT
130 PRINT"COPYRIGHT 1979 SMALL SYSTEM"
140 PRINT"SERVICES, INC."
150 PRINT"900 SPRING GARDEN STREET"
160 PRINT"GREENSBORO, N.C. 27403 USA"
170 PRINT
180 REM ALL RIGHTS RESERVED. THIS
190 REM PROGRAM MAY BE DUPLICATED FOR
```

```
200 REM USE BY INDIVIDUALS FOR THEIR
210 REM SPECIFIC MACHINE. SUCH
220 REM DUPLICATION MUST INCLUDE THE
230 REM COPYRIGHT NOTICE AND ADDRESS.
240 REM REPRODUCTION FOR COMMERCIAL
250 REM PURPOSES IS EXPRESSLY
260 REM PROHIBITED.
270 REM
280 PRINT"UTINSEL IS BEING LOADED"
290 PRINT"INTO HIGH MEMORY"
300 PRINT
310 REM
320 REM UTINSEL MACHINE CODE
330 DATA 169,0,133,48,133,52,169,0
340 DATA 133,49,133,53,76,137,195,165
350 DATA 1,72,165,2,72,162,0,160
360 DATA 0,134,1,132,2,162,1,142
370 DATA 58,3,169,13,32,210,255,32
380 DATA 210,255,32,-38,224,0,208
390 DATA 23,169,13,32,210,255,169,145
400 DATA 32,210,255,173,58,3,9,48
410 DATA 32,210,255,238,58,3,208,218
420 DATA 169,13,32,210,255,32,207,255
430 DATA 170,41,240,201,48,208,241,138
440 DATA 41,15,205,58,3,16,233,141
450 DATA 58,3,32,-38,162,0,177
460 DATA 1,149,112,224,24,240,4,232
470 DATA 200,208,244,104,133,2,104,133
480 DATA 1,76,137,195,160,0,174,58
490 DATA 3,202,240,9,177,1,201,0
500 DATA 240,22,168,208,244,32,205,253
510 DATA 32,205,253,200,177,1,201,0
520 DATA 240,6,32,210,255,24,144,243
530 DATA 200,96
540 REM
550 REM MENU TABLE
560 DATA "TOOLKIT"
570 DATA 230,119,208,2,230,120,173,0
580 DATA 0,76,154,178,0,76,196,178
590 DATA 100,0,100,0,56,233,179,0
600 DATA "WEDGE 4.0":REM FOR 32K PET
610 DATA 76,82,126,2,230,120,173,0
620 DATA 0,201,58,176,10,201,32,240
630 DATA 239,56,233,48,56,233,208,96
640 DATA "ORIGINAL"
650 DATA 230,119,208,2,230,120,173,0
660 DATA 0,201,58,176,10,201,32,240
670 DATA 239,56,233,48,56,233,208,96
680 REM
690 REM POKE MACHINE CODE TO TOP OF
700 REM FREE MEMORY
710 REM
720 TA=PEEK(52)+PEEK(53)*256-1
730 SA=TA-162
740 FORJ=SATOTA-1
750 READ B:IFB>=0 GOTO790
760 AD=B+TA: B=INT(AD/256)
770 B1=AD-B*256
780 POKE J,B1:J=J+1
790 POKE J,B
800 NEXT J
810 REM
820 REM LOAD TABLE FROM TOP DOWN
830 REM FIRST MOVE POINTER FOR STRINGS
840 REM
850 T1=INT((SA-2048)/256)
```

```

860 T2=(SA-2048)-T1*256
870 POKE48,T2:POKE49,T1
880 REM
890 REM SET N = #TABLE ENTRIES
900 REM
910 N=3
920 S1=SA
930 FORK=1 TO N
940 READ M$:EL=LEN(M$)+26
950 S2=S1:S1=S2-EL
960 POKES1,EL:IF K=1 THEN POKES1,0
970 FORJ=1 TO LEN(M$)
980 POKES1+J,ASC(MID$(M$,J))
990 NEXT J
1000 S3=S1+J:POKES3,0:S3=S3+1
1010 FOR J=S3 TO S2-1
1020 READ B:POKEJ,B
1030 NEXT J
1040 NEXT K
1050 REM
1060 REM FIX POSITION DEPENDENT CODE
1070 REM
1080 T1=INT(S1/256):T2=S1-T1*256
1090 POKE SA+22,T2:POKE SA+24,T1
1100 POKE SA+1,T2-1:POKE SA+7,T1
1110 REM
1120 REM LINK TABLE
1130 REM
1140 LA=S1:L=0
1150 IF PEEK(LA)=0 THEN GOTO 1190
1160 L=L+PEEK(LA):POKE LA,L:LA=S1+L
1170 GOTOL150
1180 REM
1190 PRINT "USE SYS" SA;
1200 PRINT "TO SET TOP OF MEMORY"
1210 PRINT "USE SYS" SA+15;
1220 PRINT "TO RUN UTINSEL"
1230 POKE52,T2-1:POKE53,T1
1240 POKE48,T2-1:POKE49,T1
1250 NEW

```

```

1 REM UTINSEL NEW-TO-OLD
2 REM COPYRIGHT 1979 SMALL SYSTEM
3 REM SERVICES, INC.
4 REM 900 SPRING GARDEN STREET
5 REM GREENSBORO, N.C. 27403 USA
7 REM TO CONVERT UTINSEL/NEW TO
8 REM UTINSEL/OLD, SUBSTITUTE
9 REM THE FOLLOWING STATEMENTS
330 DATA 169,0,133,130,133,134,169,0
340 DATA 133,131,133,135,76,139,195,165
380 DATA 210,255,32,-40,224,0,208
450 DATA 58,3,32,-40,162,0,177
480 DATA 1,76,139,195,160,0,174,58
500 DATA 240,24,168,208,244,169,32,32
510 DATA 210,255,32,210,255,200,177,1
520 DATA 201,0,240,6,32,210,255,24
530 DATA 144,243,200,96
570 DATA 230,201,208,2,230,202,173,0
600 REM DISCARD WEDGE MENU ENTRY
650 DATA 230,201,208,2,230,202,173,0
720 TA=PEEK(134)+PEEK(135)*256-1
730 SA=TA-164
870 POKE130,T2:POKE131,T1
1230 POKE134,T2-1:POKE135,T1
1240 POKE130,T2-1:POKE 131,T1

```

PET Printer Adapter

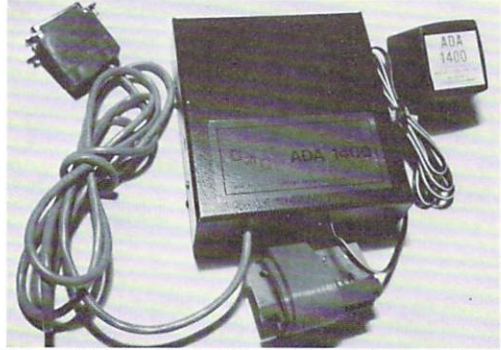

CmC's ADA 1400 drives a printer with an RS-232 interface from the Commodore PET IEEE-488 bus. The ADA 1400 is addressable, works with the Commodore disk and prints upper and lower case ASCII.

A PET IEEE type port is provided for daisy-chaining other devices.

A cassette tape is included with programs for plot routines, data formatting and screen dumps. The ADA 1400 sells for \$179.00 and includes a PET IEEE cable, RS-232 cable, power supply, case, instructions and software.

Order direct or contact your local computer store.

VISA AND M/C ACCEPTED-SEND ACCOUNT NUMBER, EXPIRATION DATE AND SIGN ORDER.
ADD \$3 PER ORDER FOR SHIPPING & HANDLING-Foreign orders add 10% for air postage.

CONNECTICUT microCOMPUTER, Inc.

150 POCONO ROAD
BROOKFIELD, CONNECTICUT 06804

TEL: (203) 775-9659 TWX: 710-456-0052

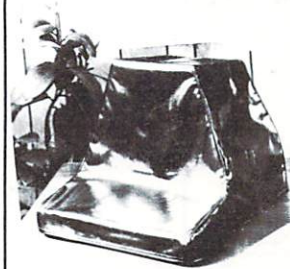

ITS COVERS . . .

**A BEAUTIFUL
COMPLEMENT
TO ANY DECOR!**

- Attractive, Durable, Leather-Grained Vinyl
- Double Stitching for Extra Strength
- Corded Seams Assure Perfect Fit
- Colors - Gold, Chestnut Brown, Olive Green or Black

PET/CBM - \$18.95

Apple II - \$12.95

Apple Disk - \$8.95

OTHER COMPUTER

COVERS AVAILABLE.

WRITE FOR DETAILS

NEW-CURSOR FOR PET 2001 OLD ROM

INSTANT PUSHBUTTON CURSOR RETRIEVAL

- Reviewed in Issue #1 of COMPUTE
- Restart without touching power
- Machine language programs in second cassette buffer not lost.
- Simple, illustrated instructions
- Installed in minutes - no soldering
- Improved mounting - no sticky tape

\$7.95

UNCRASHER for PET/CBM 2001 - New ROM - \$14.95

INTERNATIONAL TECHNICAL SYSTEMS, INC.

Box 264

Woodbridge, Virginia 22194

Phone Orders (804) 262-9709



SHIPPING AND HANDLING ADD \$1.00

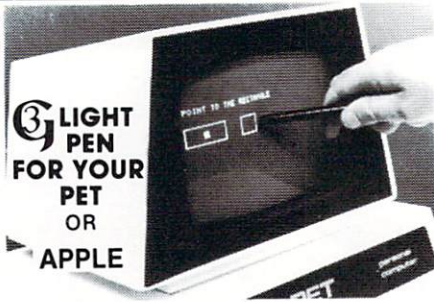

3G LIGHT PEN FOR YOUR PET OR APPLE

- Ready to plug in.
- No assembly necessary.
- Bypass the keyboard — interact directly with the screen.
- Demonstration program included.
- Complete documentation so you can write your own programs in BASIC.
- Use for education, business, games, home.
- MANY GAMES AND OTHER LIGHT PEN SOFTWARE AVAILABLE.

MAIL COUPON OR CALL TODAY

3G Company, Inc. Dept. CO (503) 662-4492
Rt. 3, Box 28A, Gaston, OR 97119

Rush me 3G LIGHT PENS. PET \$31.95 Apple \$32.95
(Add \$1.50 for mailing and handling — \$6.00 foreign.)

Enclosed is Check or Money Order Master Charge Visa

Card No. _____ Exp. date _____

Signature _____

NAME _____

ADDRESS _____

CITY _____ STATE _____ ZIP _____

REMEMBER, 3G OFFERS A 30 DAY UNCONDITIONAL MONEY BACK GUARANTEE!

QUALITY SOFTWARE FOR THE PET

*** NOW AVAILABLE FOR MODELS 2001-8, 2001-16, and 2001-32 ***
PLEASE SPECIFY YOUR MODEL NUMBER WHEN ORDERING.

◆ **CHEQUE-CHECK™** Take the worry and frustration out of balancing your checkbook, as you let this program guide you, step by step. "Remembers" entries, so you can find and correct mistakes quickly and easily ... even provides a handy way to verify your checkbook arithmetic. Fast "menu-selection" of functions. Saves a lot of time if you make a mistake! So easy to use, even beginners enjoy it. This is a practical program that should be in every PET library. \$9.95

SPECIAL OFFER

SEE COMPUTE-PON

◆ **MEM-EXPLORER™** Want to see exactly how and where your programs are stored in PET's memory? It's a snap with this **SOFTDOL PIT™** product which can be combined automatically with your own programs. Starting at the location you specify, it gives a screenful of information ... location address, contents in decimal, character or "token" interpretation, and double-byte address, integer forms. Based on the series of articles by Roy Busdicker in The Paper, this version does even more! \$9.95

◆ **METRIC-CALC™** Turn your PET into a powerful stack-oriented (PPH) calculator with many extras! Log, trig, exponential, and many other useful scientific functions in addition to Metric-English unit conversions. Switch between two "keyboards" at the touch of a key. See the stack while you operate. Look at all 20 addressable memories at one time. More functions than calculators costing many times as much. Unlike other converters, this one lets you use results in other calculations! \$9.95



*PET is a product of Commodore Business Machines, Inc.

BUY MSS PRODUCTS at better Computer Stores, or order directly from Micro Software Systems, including payment with your order. Most orders are shipped within 24 hours after receipt, via First Class Mail, postpaid.

INTERNATIONAL ORDERS: Provide payment in \$US, by check drawn on a US bank, or by International Money Order

MICRO SOFTWARE SYSTEMS

P.O. Box 1442, Woodbridge, VA 22193
PHONE ORDERS ACCEPTED 703-494-4057



— PET* OWNERS —

Write for information on these and other exciting new products to enhance your PET computer system!

- **INTELLIGENT KEYBOARD**
Full size keyboard with built-in intelligence to save keystrokes and decrease errors.
- **LOW COST MASS STORAGE**
Compact tape storage system operates 15 times faster than cassette at an affordable price.
- **2114 RAM ADAPTER**
Use 2114 RAMs to replace bad 6550 chips at one-half the price.
- **REAL WORLD SOFTWARE**
Useful programs applicable to your personal and professional interests. (No games).

OPTIMIZED DATA SYSTEMS

P.O. Box 595
Placentia, CA 92670

* TM of Commodore

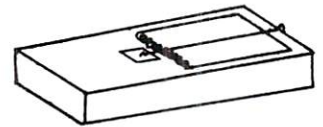

TRAP 65

For PET, APPLE, SYM, OSI, etc.
Any 1 mhz 6502!

- Prevents from "hanging up" via execution of **unimplemented opcodes!** Causes your monitor to **display location** of bad op code!
- Our computers have stopped crashing!
- **Debugging easier!**
- **Easy to install** — plugs into 6502's socket.

TRAP 65 is currently being used to insure that there are no bad opcodes in programs before submittal for ROM masks!

We are using TRAP 65 in experiments on extending the 6502's instruction set — PHX, PHY, INCD.

\$149.95 (Add \$4.00 postage, \$10.00 foreign)

Phone [919] 748-8446 or 924-2889

Eastern House Software

3239 Linda Dr.

Winston-Salem, N. C. 27106

TU presents for your PET/CBM:

NEW!

PRINTER INTERFACES

CENTRONICS TO PET (IEEE 488)

CONNECT YOUR PRINTER AS DEVICE #4 ON THE IEEE PORT AND OPERATE USING PET/CBM SOFTWARE. NO EXTERNAL SOFTWARE DRIVERS REQUIRED. WORKS WITH DISK AND OTHER IEEE DEVICES CONNECTED. IEEE DEVICE ADDRESS CAN BE CHANGED AS DESIRED. ASSEMBLED, TESTED, READY TO USE, WARRANTED, AND AVAILABLE NOW.

TU 65C.....IN STOCK.....\$129.95

RS 232 TO PET (IEEE 488)

INTERFACES YOUR RS 232 PRINTER TO THE PET 2001 SERIES COMPUTERS. USES RS 232 HANDSHAKE AND OPERATES AT 1200 BAUD (OTHER BAUD RATES AVAILABLE). NO SOFTWARE DRIVERS REQUIRED, JUST USE THE PET COMANDS DIRECTLY. POWER PACK INCLUDED. ASSEMBLED, TESTED, WARRANTED, AVAILABLE NOW, PLUG IN AND OPERATE.

TU 6514.....IN STOCK.....\$69.95

BUY TU PRODUCTS AT BETTER COMPUTER STORES, OR ORDER DIRECT FROM TYPEWRITERS UNLIMITED. TU STOCKS SELECTRIC REPAIR PARTS, MANUALS, MYLAR FILM RIBBONS, AND INTERFACES FOR MOST SELECTRICS AND PRINTERS.

*PET is a product of Commodore Business Machines, Inc.

TYPEWRITERS UNLIMITED

1408 IDAHO STREET
WOODBIDGE VIRGINIA
22191



PHONE ORDERS ACCEPTED 703-494-4057

IDENTIFY YOUR ATARI COLORS

Len Lindsay

If you have an ATARI, you probably would like to know just how the color graphics work. In this short space I can not tell you everything you want to know and don't know how to ask, but I am including a short program that will let you identify the colors available to you.

This program is designed to run in GRAPHICS 0 but you can easily change this. The key is the SETCOLOR statements. In general here is what the statement means:

```
400 SETCOLOR ITEM(0-4), HUE(0-15),
SHADE(0-14even)
```

There are three numbers that follow the word SETCOLOR. The first tells what items color we are defining (2 is the background, 1 is the characters). The second number tells what basic hue or color. The last tells the luminance or shade, the higher it is the lighter the color.

Run the program and note the color schemes that are easiest for you to read. Then simply set those colors before you start programming.

Example, I like background hue 14 at shade 0 and character shade of 10. To set up this color scheme I would issue these two direct commands:

```
SETCOLOR 2, 14, 0 :
REM BACKGROUND
SETCOLOR 1, 14, 10 :
REM CHARACTER
```

You can adjust the pause between each color shift by setting the variable PAUSE in line 0. Line 1 sets WAIT to the line number of your wait subroutine. Line 110 uses 5 cursor downs. It is hard to list this. The [5 DOWN] means program 5 cursor downs into the program line. Each one requires you hit ESCAPE, then hold the CONTROL and hit the DOWN CURSOR key. Line 3 clears the screen, you must hit ESCAPE, then hold the SHIFT and press CLR to program it into the line. Finally line 300 includes [3 UP]. You put 3 cursor ups into the line just as you did the cursor downs in line 2.

```
0 PAUSE=50 : REM LENGTH OF PAUSE
1 WAIT=1000 : REM SUBROUTINE LINE #
3 PRINT"[CLR]"
100 PRINT"THIS IS GRAPHICS MODE 0"
110 PRINT "[5 DOWN]"
200 FOR HUE=0 TO 15
210 FOR SHADE=0 TO 14 STEP 2
220 FOR CHAR=0 TO 14 STEP 2
300 PRINT"[3 UP]THIS IS BACKGROUND COLOR ";HUE;" "
310 PRINT"BACKGROUND LUMINANCE IS ";SHADE;" "
320 PRINT"CHARACTER LUMINANCE IS ";CHAR;" "
399 REM SET BACKGROUND COLOR
400 SETCOLOR 2, HUE, SHADE
409 REM SET CHARACTER LUMINANCE
410 SETCOLOR 1, HUE, CHAR
500 GOSUB WAIT
600 NEXT CHAR
610 NEXT SHADE
620 NEXT HUE
999 RUN : REM REPEAT THIS AGAIN
1000 FOR Z=1 TO PAUSE : NEXT Z
1010 RETURN
```

©

DR. DALEY presents

Software for the PET and the APPLE

Dr. Daley's software is proud to announce the release of a package of our best selling programs.

These programs, regularly retailing for over \$400, have been assembled into a single

package for only \$69.95. Included is our best selling TREK3, CHECKBOOK, and a mailing list, tutorials, games and puzzles for every member of the family. All attractively packaged in an album.

Take DR. DALEY'S Compute-pon to your local dealer and save \$5.00.

50 PROGRAMS ONLY \$69.95*

Your order will be shipped within four business days from receipt.

Charge your order to
MC/VISA



* Disk version
\$10 extra.

DR. DALEY, 425 Grove Avenue, Berrien Springs, Michigan 49103

Phone (616) 471-5514 Sun. thru Thurs., noon to 9 p.m. eastern time.

JOIN RAYGAMCO NOW!

Become a member of RAYGAMCO Computer Discount Club.

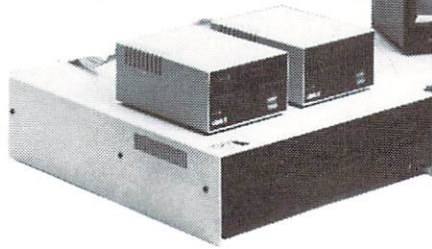

SAVE 20% AND MORE!

BIG SAVINGS ON EVERY ITEM!

By being a RAYGAMCO Member you receive substantial discounts on every item you purchase, including all hardware, software, accessories, even books and paper! You will also receive a monthly newsletter with all the latest available for your particular computer system, and much, much more — exclusive to RAYGAMCO Members only!

All the famous brand names, including:

- | | | | |
|----------------|-------------|-----------|-------------------|
| APPLE | Alpha Micro | Soroc | Lear Siegler |
| ATARI | Alpha Pro | Hazeltine | Shugart |
| EXIDY/Sorcerer | Cromemco | Sektor | Texas Instruments |
| Kim/Commodore | Xerox | PET | |

SAVE 20% AND MORE!

Here's how to join.

Fill out the information, and mail. That's all there is to it. Nothing to buy. I want to be a RAYGAMCO Computer Discount Club Member. Please send my RAYGAMCO Membership card to:

Name _____

Address _____

City _____ State _____ Zip _____

Computer (Brand Name) _____

I would like information on (please specify system, part, accessory, book, program, etc.) _____

WE HONOR VISA, MASTERCHARGE, BANKAMERICARD.

TOLL FREE, EXCEPT CA

Store Hours: Sat 10-6, Sun 12-4, Tu-Fri 11-8

800-854-6455

RAYGAM, INC.

6791 WESTMINSTER AVENUE WESTMINSTER, CA 92683

TELEX 182274

(714) 891-2587



MANUAL ALPHABET TUTORIAL ON A PET

Susan Semancik
the Delmarva Computer Club

“Can microcomputers be used to help the handicapped?”, “What could a PET computer do for the deaf?”, “Could the PET’s special graphic keys be used to draw hand positions for sign language?” - these were a few of the many unanswered questions I had after concluding a computer demonstration for the director of a summer workshop for the handicapped. My background as a teacher and as a mathematician at NASA’s Wallops Flight Center usually placed me in a really good position to handle requests for information concerning computer applications to education. But, not even knowing the manual alphabet, much less sign language, left me uncertain as to its simulation on the PET computer. Since I did not know enough about it to say “No” to any of the above questions, I, of course, said that the Delmarva Computer Club would look into the matter.

The Club was formed in early '79 with three primary goals - aiding the handicapped, bringing computer awareness to the community, and providing the opportunity to the community to use and program computers. With a membership composed of diverse abilities, interests and backgrounds, it did not take long to find the members who possessed the talents necessary to embark on this challenge. Among them was Jan Siglin, a local artist and high school teacher who agreed to try translating book drawings of the manual alphabet into PET graphic characters, and Lance MacAllister, a speech pathologist at a handicapped center who agreed to try the finished computer program with several of his non-verbal clients to see if it could be useful as a teaching aid.

It all seemed simple enough. We had professional people handling all aspects of the program. What possible problems could develop? Let’s start at the beginning with Jan’s version of things:

“I have always been interested in working with the handicapped and in educational programs, but my lack of computer know-how had me worried. I knew enough to type ‘RUN’ and hit RETURN and that was about it. That plus the fact that I did not know one letter of the manual alphabet should have been enough to make me say ‘No’”. Instead, I said, I would try.

“The first problem was finding out what the manual alphabet looked like. Several books were used to get information, but each book presented drawings with different hand positions. How was

I to know which ones were more widely used? We made several trips to the summer workshop for the handicapped, whose director initiated the idea for the program. This gave us opportunities to actually see signing, and have signers look at the drawings and help us clear up some of the ambiguities. In some cases, I even abandoned the book drawings and made sketches of some of the signers’ hand positions for the letters. Figure 1 is a sample book drawing of the letter O in the manual alphabet, and Figure 2 is my simplified sketch of a signer’s hand position for the letter O.

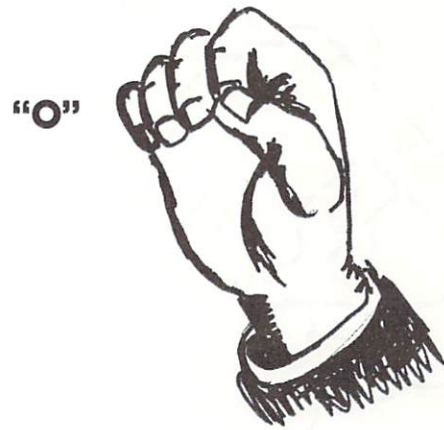

FIG 1

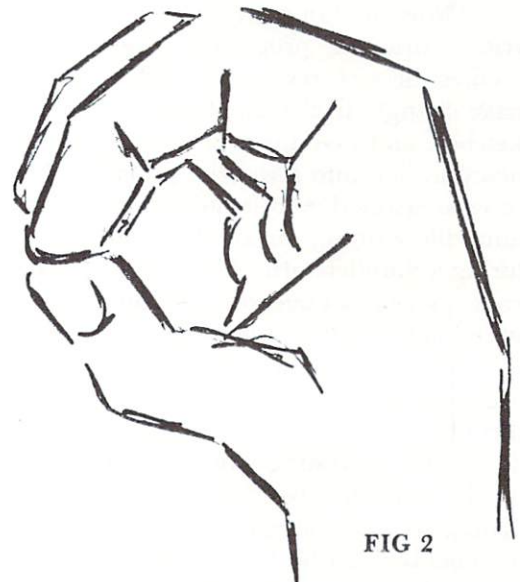

FIG 2

Sketches by Jan Siglin

“Once the twenty-six drawings were approved by the people at the workshop, I then broke each sketch down into corresponding PET graphic symbols. Inasmuch as a PET computer was not constantly available, I had to rely on a xeroxed copy of the keyboard from a PET manual, and graph paper for correct positioning of the PET symbols. Since only one PET character could be used in each graph paper square, the hardest part was keeping the drawing simple enough without losing the identity of the letter. Improvisations included the use of an occasional non-graphic character, such as a number, letter, arithmetic symbol or punctuation mark. Figure 3 is the graph paper sketch of the letter O from the manual alphabet, using PET graphic symbols.

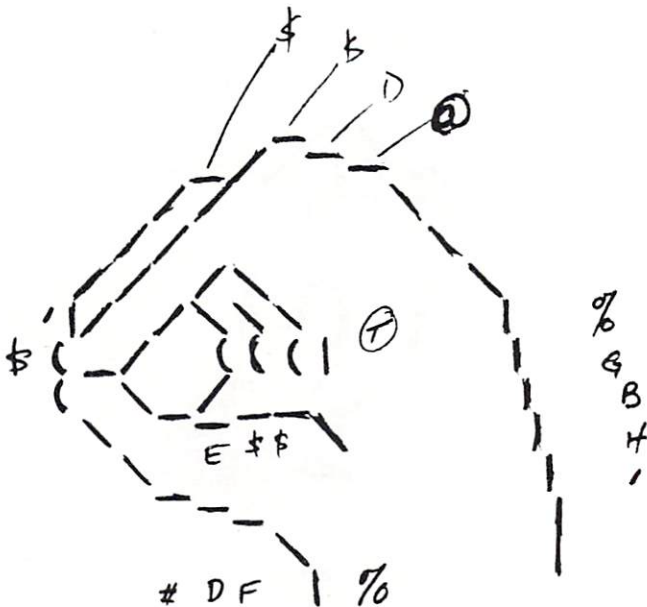

FIG 3

“Now the fun really started. Sue had to write a ‘drawing’ program for me to be able to enter the pictures on the PET’s screen, make changes in the drawings as I improved sketches, and save them on tape for later incorporation into a tutorial program. Except for tape errors due to lengthy tape leaders and faulty file writing, for an electrical interruption during a thunderstorm that wiped out three hours work, and for an overzealous club member who twice inadvertently pulled the computer’s plug before the sketches were safely saved on tape, I really did not have too many problems with this part of the program!

“The interesting letters for me had to be J and Z, since they both required motion in their signing. It took four different hand positions to adequately describe J’s path of motion. Z was simpler for me, but harder for Sue, as one drawing had to be moved to four different screen locations. Before I let Sue start telling

you about the programming challenges she encountered, I really want to say how amazing it was for me to see what could be done with the PET’s graphics.”

For each character used in Jan’s sketch of a hand position, two pieces of information were necessary: one, the character that was used, and the other, the address of the screen position that it occupied. This involved almost 4300 contiguous memory locations for the set of twenty-six drawings. Then additional bytes were necessary for the assembly language program that would instantaneously draw the pictures, and for the BASIC program that would teach and test you on the manual alphabet. All of this had to fit into an 8K PET, since that is the size with which both the Club and the Holly Center had to work.

Flowchart 1 illustrates the logic involved in the BASIC tutorial program. A twenty-seven element array is used to store the starting memory location of each drawing of the letter of the alphabet and the stopping memory location for the letter Z. This way, except for the first and last elements, each array value can represent either a starting or stopping point for the information required to draw a hand position.

When the program is run, the user is requested either to type in a letter of the alphabet for teaching its hand position, or to type in the word “TEST” for testing recognition of the entire manual alphabet. As can be seen from the flowchart, once the test is started, the only way it will stop is after the user successfully identifies all twenty-six letters. The number of mistakes is not counted, only the successes. Each drawing is shown in a random order, and as it is recognized by the user, a scoring array flags that letter so it will not be shown again. At any point in the test, the user can type “HELP”, and the answer will be printed on the screen by the computer; but, the drawing will randomly appear again for the user to identify.

As was mentioned earlier, two letters of the manual alphabet require motion. For the letter J, four different drawings are used, since the hand turns in tracing a J-shaped path. A separate subroutine keeps track of where each of these drawings start within the area allocated for J. A delay has to be used between each drawing in order for the eye to absorb enough detail to identify each hand position. The letter Z needs only one drawing, since no twisting is involved in tracing the Z-shaped path. The Z drawing is placed on the screen, then moved horizontally to the right, then diagonally to the lower left, and then horizontally to the right, with a similar delay in between. In the drawing, every character’s screen location has an appropriate constant added to it in order to achieve each displacement.

Without the assembly language program, which is responsible for putting each drawing almost spontaneously on the PET's screen, this animation would not be so realistic. Zero page locations are used as pointers for the starting memory location of the requested drawing. The number of characters in the drawing are calculated and placed in the appropriate location of the assembly program by the BASIC tutorial program. Using indexed indirect addressing, the assembly program loops through the memory locations for that letter, pairwise selecting the next screen location to be used and the graphic character to be placed there. After a ROM subroutine does the actual printing of the character, control is returned to the BASIC program. Picture #2 is an actual photograph of the letter O from the manual alphabet as it appears on the PET screen after the assembly language program has gone through this process.

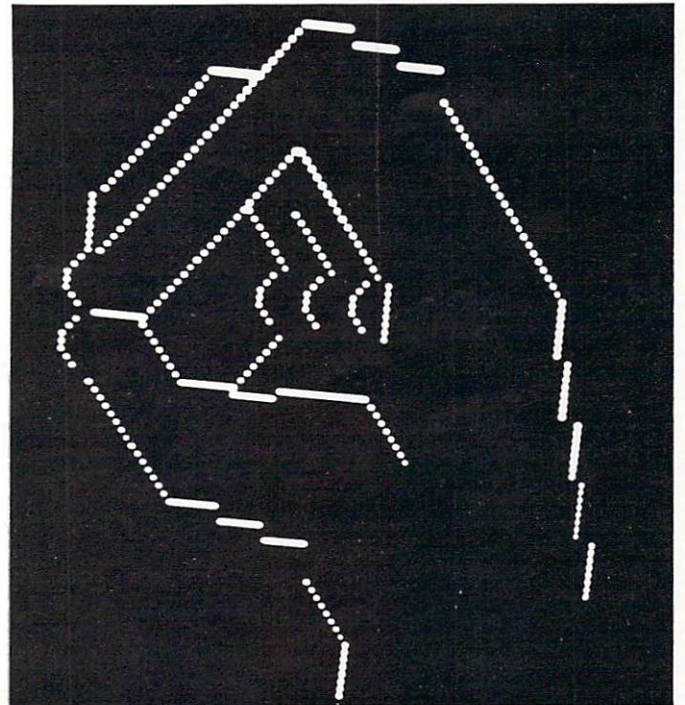

With the initial programming aspect of the project completed, it was now time to test its effectiveness. The Club demonstrated the program at two local libraries that were teaching beginning sign language classes, and no one seemed to have great difficulty recognizing the signs. Then it was up to Lance MacAllister to try the Manual Alphabet Tutorial with some of his non-verbal clients at the Holly Center. I'll let him describe the Center and his experiences using the computer program:

"Holly Center is a 225 bed, State facility for the developmentally disabled, located on the Eastern Shore of Maryland. One specific problem affecting all our clients is communication and language delay. Many of our clients are non-verbal and use non-verbal communication modes

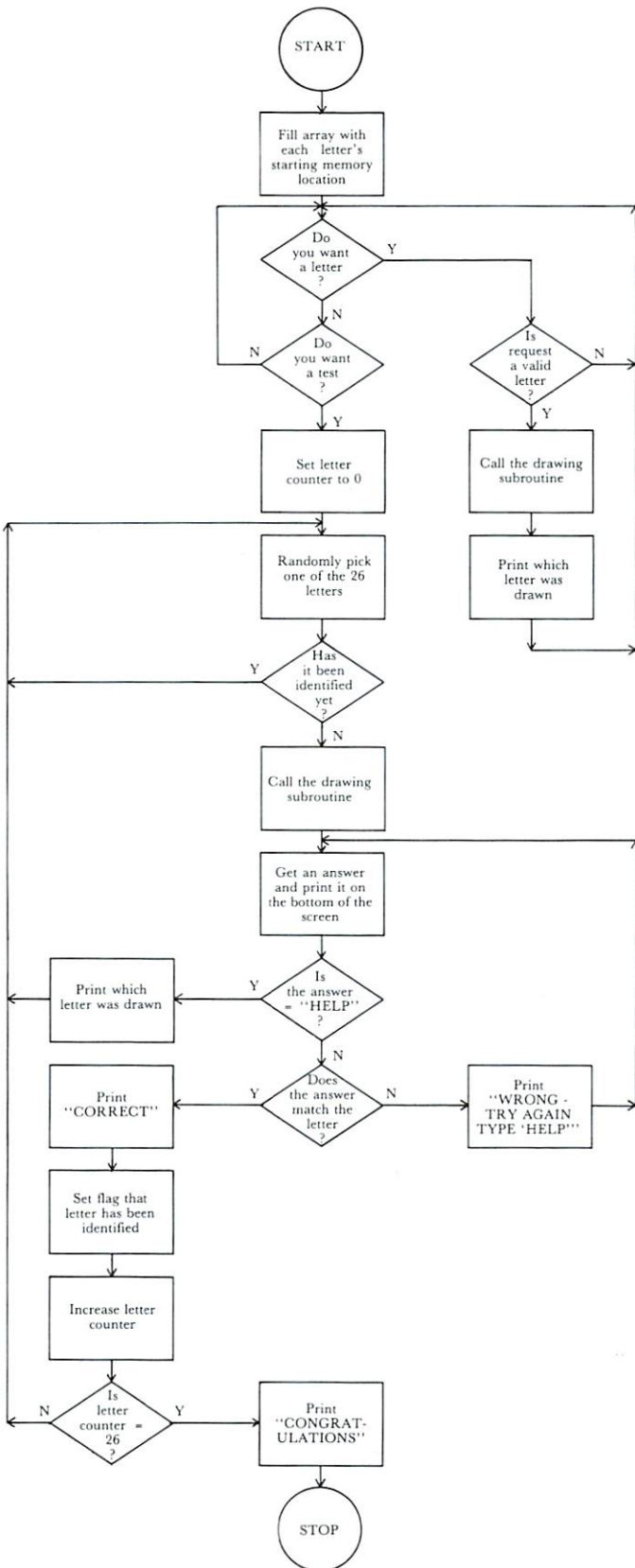

Our Latest Arrivals

Education, games, business, electronics—you'll find what you have been looking for in this batch of new programs from Instant Software.

PET*

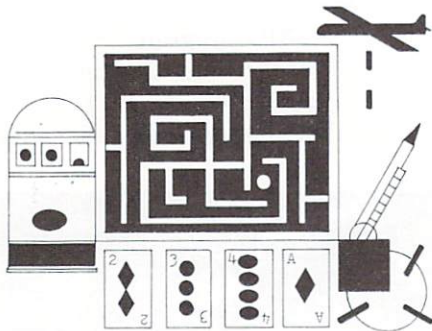

PET DEMO I You can give yourself, your family, and your friends hours of fun and excitement with this gem of a package.

- Slot Machine**—You won't be able to resist the enticing messages from this computerized one-armed bandit.
 - Chase**—You must find the black piece as you search through the ever-changing maze.
 - Flying Pheasant**—Try to shoot the flying pheasant on the wing.
 - Sitting Ducks**—Try to get your archer to shoot as many ducks as possible for a high score.
 - Craps**—It's Snake Eyes, Little Joe, or Boxcars as you roll the dice and try to make your point.
 - Gran Prix 2001**—Drivers with experience ranging from novice to professional will enjoy this multi-leveled race game.
 - Fox and Hounds**—It's you against the computer as your four hounds try to capture the computer's fox.
- For true excitement, you'll need a PET 8K. Order No. 0035P \$7.95.

CODE NAME:CIPHER Empires have risen and fallen because of secret codes and code breakers. Now you can enjoy that same feeling of intrigue and discovery with the Code Name: Cipher package. Included in the package are:

- Memory Game**—Would you like to match your memory against the computer's? You can with the Memory Game.
- Codemaster**—You and another player can compete to see who will be the "codemaster." One player types in a word, phrase, or sentence, and the PET

translates that message into a cryptogram. The other player must break the code and solve the cryptogram in the shortest time possible.

- Deceitful Mindmaster**—This isn't your ordinary Mastermind-type game. You must guess the five letters in the hidden code word. The computer will give you hints as to how close your guesses are.
- Code Breaker**—Cracking this code won't be as easy as cracking walnuts. You'll need to flex your mental muscles to win this game.

If you want a mental challenge, if you want to pit your wits against the faultless logic of the computer, then Code Name: Cipher is for you. For the 8K PET. Order No. 0112P. \$7.95.

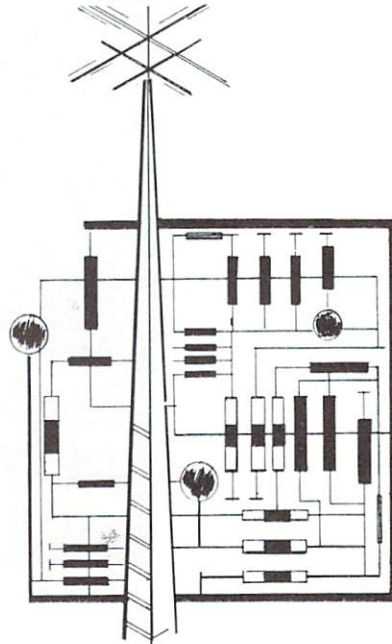

HAM PACKAGE I This versatile package lets you solve many of the problems commonly encountered in electronics design. With your 8K PET, you have a choice of:

- Basic Electronics with Voltage Divider**—Solve problems involving Ohm's Law, voltage dividers, and RC time constants.
- Dipole and Yagi Antennas**—Design antennas easily, without tedious calculations.

This is the perfect package for any ham or technician. Order No. 0054P \$7.95.



DECORATOR'S ASSISTANT This integrated set of five programs will compute the amount of materials needed to redecorate any room, and their cost. All you do is enter the room dimensions, the number of windows and doors, and the base cost of the materials. These programs can handle wallpaper, paint, panelling, and carpeting, letting you compare the cost of different finishing materials. All you'll need is a PET 8K. Order No. 0104P \$7.95.

ACCOUNTING ASSISTANT This package will help any businessman solve many of those day-to-day financial problems. Included are:

- Loan Amortization Schedule**—This program will give you a complete breakdown of any loan or investment. All you do is enter the principal amount, interest rate, term of the loan or investment, and the number of payments per year. You see a month-by-month list of the principal, interest, total amount paid, and the remaining balance.
- Depreciation Schedule**—You can get a depreciation schedule using any one of the following methods: straight line, sum of years-digits, declining balance, units of production, or machine hours. Your computer will display a list of the item's lifespan, the annual depreciation, the accumulated depreciation, and the remaining book value. This package requires the PET 8K. Order No. 0048P \$7.95.

ELECTRONIC ENGINEER'S ASSISTANT Now you can use your computer to analyze designs for filter circuits and microstrip transmission lines.

- Network Analysis**—Your computer can help you design and analyze four-terminal AC networks. Just enter the input load impedance, component values, and the frequency range. Your computer will analyze the circuit and display the gain, the real input impedance, and the imaginary input impedance throughout

“Before actual exposure to the manual alphabet program, our clients were given periods of ‘free play’ at the computer keyboard. They would in earnest fill the screen with graphic designs, letters and numbers and then, well satisfied, would remove them as quickly as they appeared, using the erase key. These perseverative experimentations were shaped into the matching of a letter on a card to the same letter on the keyboard. Soon the clients were typing words onto the screen copied from the cards. [Note in the picture of George, how intently he is working on this task.] Each client learned to type his own name relatively quickly. As a reward for ‘good work’, at the termination of a training session a simple program was used that allowed a client to determine the number of times he wanted his name to appear on the screen. This event, simple as it might be, was a good motivator.

“The manual alphabet program was used as a supplement to the clients regular manual signing/fingerspelling (expressive use of the manual alphabet) program. Since the clients could form most letters of the manual alphabet and had exposure in matching the letter to its hand shape, the transition from a concrete presentation (reading the therapist’s hand shape) to the pictorial presentation (identification of the hand shape on the PET monitor) was made easier. With developmentally delayed clients, the identification of an object (a concrete presentation) is cognitively an easier task than the identification of the object’s picture.

“Each client was taken through the letter identification stage of the manual alphabet program. Five letters were practiced and then tested during each training session. The ‘letter’ mode of the program was used for teaching and testing initially. This allowed, for testing

purposes, inclusion of only the letters practiced. When all letters had been covered, the ‘testing’ mode of the program was used. [Note that in the pictures, the clients are making the correct handshape as well as typing the letter in response to a drawing on the PET screen.] Over a period of four months, one client increased his identification of manual alphabet letters from 10 to 16. Another client increased his letter identification from 14 to 22. The third client has only been involved in the alphabet program one month. He advanced from identification of 13 to 18 letters.

“In following the progress of the three clients using the manual alphabet program, I feel that I’ve targeted some problem areas within the program which, if modified, would create a more effective teaching tool. The use of unconnected or uneven lines on some of the graphic illustrations created abstract reproductions of the manual alphabet symbol. In the letters D, G, Q, R, and X, many finger reproductions were undefined. All three clients had difficulty with these letters. Frequently, the client would push the RETURN key when the program called for a letter identification. This would trigger the READY response and the pro-

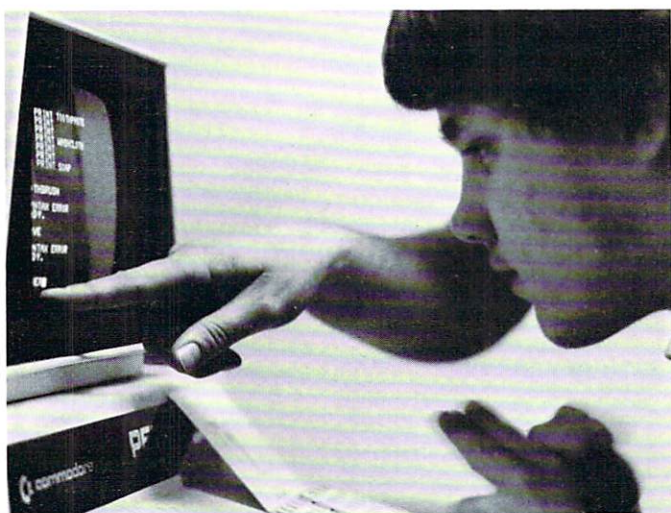

gram would have to be started again. The clients initially spent much of the teaching session re-starting the program due to this problem. Also, information words such as 'correct' and 'wrong' were not part of the clients reading vocabulary. If these words could be represented by an animated picture such as a happy face to symbolize correct and a sad face to symbolize wrong, these concepts could be communicated without the teaching of the word's meaning. The animated face would also offer a more positive response than the bleak listing of the words.

"I foresee the PET becoming an integrated part of communication and language programming at Holly Center. I am grateful for the efforts of the other members of the Delmarva Computer Club in adding another dimension to the teaching of the manual alphabet for our clients. I look forward to the Club's continued technical assistance and support in furthering the multiple uses of the PET in communication and language programming for developmentally delayed clients."

Since the Holly Center has found some success with this program, it will be expanded to include the above revisions and to include the fingerspelling of several letters at one time, with some ability to change the speed at which the letters will be shown together. These programs will also be tried at this summer's handicapped workshop, with, I am sure, more refinements and new ideas developing from its continued use. If anyone is interested in the further developments of this or other programs to help the handicapped, please relay your interests and ideas to the Delmarva Computer Club, in care of Jean Trafford, secretary, P.O. Box 36, Wallops Island, Virginia 23337.

©



PET Word Processor

**8K
and
16/32K
PET
versions**



This program permits composing and printing letters, flyers, advertisements, manuscripts, etc., using the COMMODORE PET and a printer.

Printing directives include line length, line spacing, left margin, centering and skip. Edit commands allow you to insert lines, delete lines, move lines and paragraphs, change strings, save files onto and load files from cassette (can be modified for disk), move up, move down, print and type.

Added features for the 16/32K version include disk and cassette support written in, string search for editing, keyboard entry during printing for letter salutations, justification, multiple printing, pagination, tabbing, paragraphing, and more.

A thirty page instruction manual is included.

The CmC Word Processor Program for the 8K PET is \$29.50. The 16/32K version is \$39.50.

Order direct or contact your local computer store.

VISA AND M/C ACCEPTED - SEND ACCOUNT NUMBER, EXPIRATION DATE AND SIGN ORDER. ADD \$3 PER ORDER FOR SHIPPING & HANDLING - FOREIGN ORDERS ADD 10% FOR AIR POSTAGE.

CONNECTICUT microCOMPUTER, Inc.
150 POCONO ROAD
BROOKFIELD, CONNECTICUT 06804
TEL: (203) 775-9659 TWX: 710-456-0052

DISK DRIVE WOES? PRINTER INTERACTION? MEMORY LOSS? ERRATIC OPERATION? DON'T BLAME THE SOFTWARE!

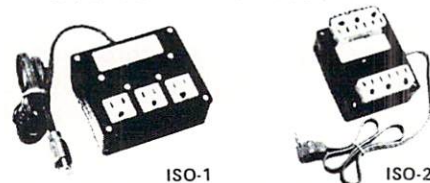

- Power Line Spikes, Surges & Hash could be the culprit! Floppies, printers, memory & processor often interact! Our unique ISOLATORS eliminate equipment interaction AND curb damaging Power Line Spikes, Surges and Hash.
- *ISOLATOR (ISO-1A) 3 filter isolated 3-prong sockets; integral Surge/Spike Suppression; 1875 W Maximum load, 1 KW load any socket \$54.95
- *ISOLATOR (ISO-2) 2 filter isolated 3-prong socket banks; (6 sockets total); integral Spike/Surge Suppression; 1875 W Max load, 1 KW either bank \$54.95
- *SUPER ISOLATOR (ISO-3), similar to ISO-1A except double filtering & Suppression . . . \$79.95
- *ISOLATOR (ISO-4), similar to ISO-1A except unit has 6 individually filtered sockets . . . \$93.95
- *ISOLATOR (ISO-5), similar to ISO-2 except unit has 3 socket banks, 9 sockets total . . . \$76.95
- *CIRCUIT BREAKER, any model (add-CB) Add \$ 6.00
- *CKT BRKR/SWITCH/PILOT any model (-CBS) Add \$11.00

PHONE ORDERS 1-617-655-1532
 
 171 South Main Street, Natick, Mass. 01760
 Dept.pg

PET TWO-WAY RS-232 and PARALLEL OUTPUT INTERFACE

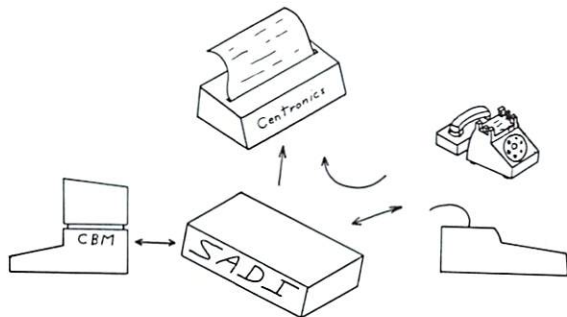

SADI - The microprocessor based serial and parallel interface for the Commodore PET. SADI allows you to connect your PET to parallel and serial printers, CRT's, modems, acoustic couplers, hard copy terminals and other computers. The serial and parallel ports are independent allowing the PET to communicate with both peripheral devices simultaneously or one at a time. In addition, the RS-232 device can communicate with the parallel device.

Special Features for the PET interface include:

- Conversion to true ASCII both in and out
- Cursor controls and function characters specially printed
- Selectable reversal of upper and lower case
- PET IEEE connector for daisy chaining
- Addressable - works with other devices

Special Features for the serial interface include:

- Baud rate selectable from 75 to 9600
- Half or full duplex
- 32 character buffer
- X-ON, X-OFF automatically sent
- Selectable carriage return delay

Special Features for the parallel interface include:

- Data strobe - either polarity
- Device ready - either polarity
- Centronics compatible

Complete with power supply, PET IEEE cable, RS-232 connector, parallel port connector and case. Assembled and tested.

SAD1a (110VAC) \$295

SAD1e (230VAC) \$325

Order direct or contact your local computer store.

CONNECTICUT microCOMPUTER, Inc.

150 POCONO ROAD

BROOKFIELD, CONNECTICUT 06804

TEL: (203) 775-9659 TWX: 710-456-0052

VISA AND M/C ACCEPTED - SEND ACCOUNT NUMBER, EXPIRATION DATE AND SIGN ORDER.
ADD \$3 PER ORDER FOR SHIPPING & HANDLING - FOREIGN ORDERS ADD 10% FOR AIR POSTAGE.



Try a Really Different Kind of Software for Your TRS-80, PET, or APPLE!

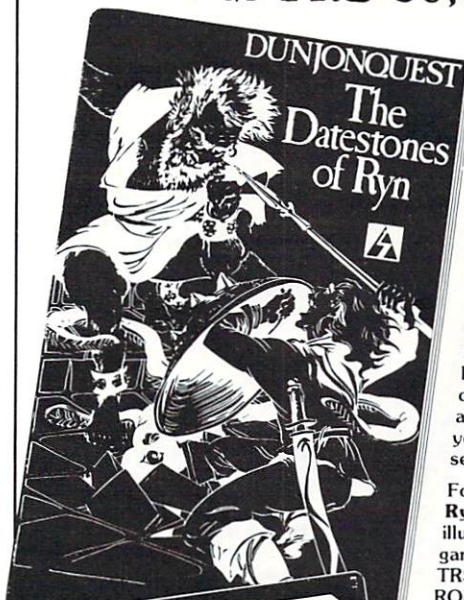

Cross swords with a band of dastardly robbers in their mountain lair in the **Datestones of Ryn**. You explore the caverns shown on your video display and vanquish the monsters in real time. You have just 20 minutes to recover the precious Datestones before time itself stops.

Monsters—Meles—Magic!

The **Datestones of Ryn** introduces you to the superlative DUNJONQUEST game system. Other games in the series may pit you against an evil wizard or the frightful insectoid monsters of the god Apschai. In the **Datestones** your main opponents are human, but look out for other nasty critters lurking in the darkness. You have 14 different commands ranging from moving (as fast or as slow as you like so long as you don't tire yourself out) to searching the walls for secret doors.

For just \$14.95 you get the **Datestones of Ryn** on cassette ready to play, and a superbly illustrated booklet that tells you all about the game. Please specify the version you want—TRS-80 (Level II, 16K), PET (16K old or new ROMS), or APPLE (32K Applesoft).

Ask your dealer or send today to:



**AUTOMATED
SIMULATIONS**

Dept. R5
P.O. Box 4232
Mountain View, Ca. 94040



California residents please add 6% sales tax.



NEW from MICRO-ED!

A series of MICRO-ED Programs For The Pet[®]

MICRO-DOZEN ONE All 12 Tapes for \$84.00

- **COUNT 'EM** (Kindergarten and 1st grade) The learner counts from one to ten steam locomotives on the computer screen.
- **Story Problems in Addition and Subtraction** (Elementary) An assortment of story problems in addition and subtraction, many of which involve lords and knights and a great castle.
- **What Number Is Missing?** (Kindergarten, 1st grade) Digits from one to nine appear in sequence. But one digit is always missing. Which one?
- **Tachistoscope** (Elementary) Groups of words are flashed on the screen. The student must reproduce them correctly at the computer keyboard.
- **Identifying Complete Sentences** (Elementary) Groups of words are presented on the screen. Which ones are complete sentences?
- **Lines and Spaces of the Treble Clef** (Elementary and up) Using whole notes with sound, the computer teaches the student the names of the lines and spaces that make up the treble clef.
- **Matching Capital Letters** (Pre-school and kindergarten) Large capital letters appear on the screen. What letters on the computer keyboard match them?
- **Which Letter Comes Next?** (Primary) A large capital letter appears on the screen. What letter comes next in alphabetical order?
- **Haiku** (Elementary and up) The computer writes poetry which it revises, line by line, upon request. This program can be used to help students write creatively.
- **Trail West** (Elementary) A journey to the goldfields of the Old West.
- **Direction and Distance** (Elementary) A game to teach the directions of North, Northeast, Southwest, etc.
- **Math Bid** (Elementary) An achievement motivation game, involving practice in addition, subtraction, multiplication, and division.

For further information on these and other tapes, send for free brochures from MICRO-ED.

OTHER PROGRAMS NOW AVAILABLE INCLUDE:

A Major DRILL AND PRACTICE SPELLING SERIES To Supplement Regular Classroom Instruction

Five levels—A, B, C, D, E—cover grades 2 through 6. Complete set consists of 35 tapes with a total of 180 lessons. Each level has seven tapes containing thirty-six lessons.

- LEVEL A: 7 tapes—36 lessons—grade 2—\$49.95
- LEVEL B: 7 tapes—36 lessons—grade 3—\$49.95
- LEVEL C: 7 tapes—36 lessons—grade 4—\$49.95
- LEVEL D: 7 tapes—36 lessons—grade 5—\$49.95
- LEVEL E: 7 tapes—36 lessons—grade 6—\$49.95

ENTIRE SPELLING SERIES—\$225

A SAVINGS OF \$24.00.

WORD DEMONS

2 tapes—\$14.95

Tape one:

There-Their-They're

Tape two:

To-Too-Two

USAGE BONERS

15 tapes—\$99.00

This drill and practice series focuses on common mistakes in usage, such as agreement between subject and verb, double negatives, etc.

Any Individual Tape Can Be Purchased For \$7.95.

MICRO-ED welcomes your suggestions for needed programs.

MICRO-ED, INC.

P.O. Box 24156, Minneapolis, MN 55424

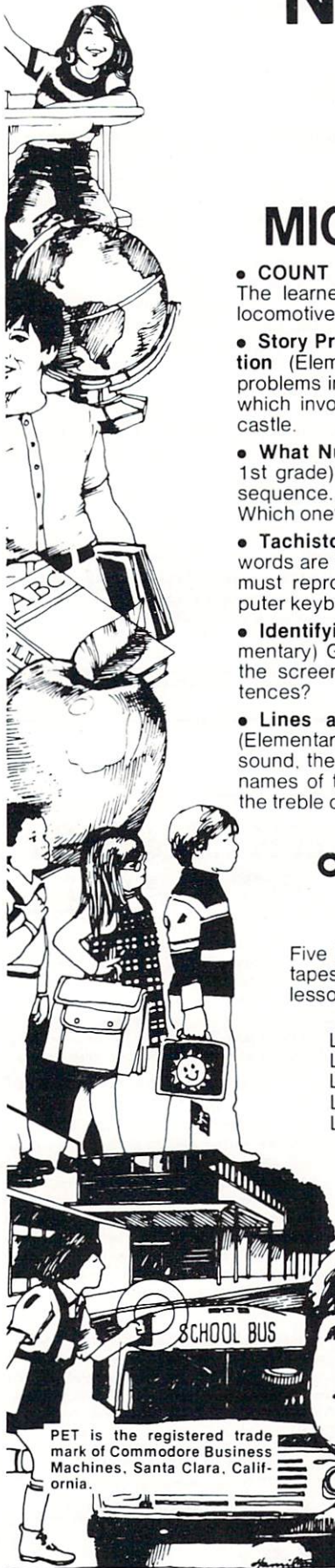

PET is the registered trade mark of Commodore Business Machines, Santa Clara, California.

The Learning Lab

Marlene Pratto,
COMPUTE Staff

INTRODUCTION

All teachers are faced with the task of making judgments about their students through grading. This program and the PET will help the teacher calculate term or partial term grades. In addition, the program may help the teacher make some judgments about his or her teaching of a particular course by calculating the mean and standard deviation for each of the grades and by providing a frequency distribution of the students' Z scores (standard scores) for term or partial term averages.

The students' grades, averages, Z scores, means and standard deviations of the grades, and frequencies of the Z scores in standard deviations units are stored in arrays. After all the calculations have been done, a menu is presented which enables the user to review any of these. In addition, the user may choose to identify the students by name or a numeric identifier. If chosen, these identifiers will also be printed with the grades and averages. When entering grades the user need not copy the computed grade averages from the screen.

When there are more than ten students and the user is using the menu, the screen will show information for ten students at a time, allowing the user to choose when to continue the display.

The user may choose to weight the grades in some fashion. The weights need not add to one hundred percent, but may not exceed one hundred percent. When the weights do not add to one hundred percent, the program assumes that the grades are being calculated for a partial term and will adjust the average as though all the grades were used with the weights maintained in proportion to the entered weights. The weights are entered as percents such as 25, 10, 33 for three grades.

Z scores are calculated after all averages have been computed. The mean is subtracted from each student's average and the result divided by the standard deviation. The frequency distribution of these scores shows how many students fall within \pm three standard deviations from the group mean.

The grading program is self-documenting to a large extent and instructions are provided for the user as needed. Answers are checked to be certain that they are within the bounds accepted by the program for proper branching. For example, you may answer "YES", "YEH", or "YUP" as a positive response since the only character of interest to the program is the "Y".

The next portion of this article is for those who want to know more about the program and for those who may wish to shorten it by eliminating some of the checking and instructions. See the caution in the last paragraph if you decide to do this.

PROGRAMMING DESIGN

1. A grading program need not keep all the information in arrays, but if arrays are used, the menu at the end of data entry allows the user to review any of the information. Since the PET allows string arrays, we may also choose identifiers for the students. Again, the user need not enter the grades and copy the average from the screen because all information including identifiers is retained for easy viewing at the end.

2. The PET computes with nine decimal digits. Grades are generally expressed with two decimal digits and hence (without rounding) we are getting more information than we may want. Several methods could be used to overcome this. All information could be calculated in integer form. In this case, we would need to make some decision concerning the truncating of grades. This program computes using all nine digits and gives the user the option of whether to round or not. The method of rounding is shown in statements 12900 and 13000. We first add R1, which is set at .05 (a value of $\frac{1}{2}$ in the first place beyond the digit we wish to have rounded). Then we multiply by R%, which is set at 10 and assign the result to a fixed point number in order to save the three desired digits. Now we divide by R% and assign the result to a floating point number to have the number in proper form, i.e., dd.d where d is a digit. We are still getting one more digit than properly allowed for two digit grades, but it has been included since some teachers use it for determining borderline grades.

3. GOTOless programming is just about impossible in a relatively non-structured language such as BASIC. However, some GOTOs can be avoided. When the program is ready to utilize an IF...THEN statement to test a user's response or the value of a variable for decision making purposes, statements can precede the IF...THEN which assume the simplest condition. For an illustration look at statement 6800. In this case, we are assuming that the grades will not be weighted and thus assign the weights a value of 1. The question as to whether or not to weight is asked in 6900 and 7000. If you choose not to weight the grades, the program proceeds to 10100. When using GOTOs it is preferable to proceed to statements which are higher in number as often as possible. This makes reading the program proceed in a straight-forward fashion. When a backward GOTO is needed it should not be too far from the

current statement. Such "backward" GOTOs are needed if the user does not respond to a question with an acceptable answer and the question must be repeated. See for example, lines 5100 and 5200.

4. The GET statement in PET BASIC provides an excellent method of user control in a program. Those users without printers need time to view information on the screen and need control over how long the information is available for viewing. The GET statement coupled with an instruction to the user provides this control. Note this use in statements 23300 to 23600. The statements 23300, 23400, and 23500 provide the instruction and 23600 receives the user response. While the user is not responding the statement loops back to itself. Once a key is depressed the program continues.

5. Sprinkled throughout the program are single PRINT statements. These are merely used as spacers so that information printed is easier to read.

6. This version of the grading program has been designed to conform to COMPUTE's publishing standards for programs. These standards and the use of the NEC Spinwriter make the program very easy to read. There are no mysteriously fuzzy symbols to be concerned with. However, experienced programmers may want to make a few changes when keying in the program. The PRINT statements which were too long for clear reproduction have been spread over two or more lines. When these print on the screen some words may be split over two lines. This can be corrected by inserting the proper number of spaces to force the word onto the next line.

CHR\$(18) has been used to indicate that the next item printed will be in reverse video, while CHR\$(146) turns reverse video off. It is easy to incorporate these with key strokes in the PRINT statements and save a few lines of the program. Reverse video is used frequently in the program to indicate the responses that the user may choose.

If you do make changes in the program to use 80 character logical lines, do not change the numbering; merely omit some numbers. Next issue's column will show how to save the student grade data on tape or disk. We will provide the changes based on the numbering used here. This program is designed for a 16/32K PET or CBM with new ROMs.

```

100 REM COPYRIGHT C 1979 BY
200 REM SMALL SYSTEM SERVICES, INC.
300 REM COMPUTES GRADE AVERAGES,
400 REM Z SCORES AND A FREQUENCY
500 REM DISTRIBUTION OF Z SCORES IN
600 REM STANDARD DEVIATION UNITS.
700 REM DIM SET FOR 50 STUDENTS
800 REM AND AT MOST TEN GRADES PER
900 REM STUDENT.
1000 REM USER RESPONSES:
1100 REM A$  WEIGHTING
1200 REM B$  ANOTHER STUDENT
1300 REM C$  Z SCORES
1400 REM D$  IDENTIFIERS
1500 REM J  NUMBER OF STUDENTS
1600 REM N  NUMBER OF GRADES PER
1700 REM  STUDENT
1800 DIM Sums(10), WEIGHTS(10)
1900 DIM GSQ(10), MEAN(10), SDEV(10)
2000 DIM STUDENT(50,10), AVERAGE(50)
2100 DIM NS(50), Z(50)
2200 PRINT "[CLR]"
2300 PRINT "THIS PROGRAM ASSUMES THAT ";
2400 PRINT "YOU DO NOT HAVE MORE THAN ";
2500 PRINT "50 STUDENTS AND 10 ";
2600 PRINT "GRADES PER STUDENT. IF ";
2700 PRINT "YOU DO, CHANGE THE DIM ";
2800 PRINT "STATEMENTS ."
2900 PRINT
3000 PRINT "THE CALCULATIONS ARE DONE ";
3100 PRINT "WITH THE MAXIMUM NUMBER ";
3200 PRINT "OF DIGITS FOR THE PET. ";
3300 PRINT "TWO DIGITS ARE GENERALLY ";
3400 PRINT "SIGNIFICANT .YOU MAY, ";
3500 PRINT "HOWEVER CHOOSE ";
3600 PRINT SPC(6);
3700 PRINT CHR$(18); "0"; CHR$(146);
3800 PRINT ") NO ROUNDING OR"
3900 PRINT SPC(6);
4000 PRINT CHR$(18); "1"; CHR$(146);
4100 PRINT ") ROUNDING TO 1 DIGIT ";
4200 PRINT "TO THE RIGHT OF THE DECIMAL "
4300 PRINT: PRINT SPC(7);: INPUT D%
4400 IF D% > 1 THEN PRINT: GOTO 3600
4500 IF D% < 0 THEN PRINT: GOTO 3600
4600 PRINT "THE PROGRAM ASSIGNS ";
4700 PRINT "NUMBERS TO THE STUDENTS. ";
4800 PRINT "WOULD YOU PREFER SUPPLYING";
4900 PRINT " OTHER IDENTIFIERS";
5000 INPUT D$: D$ = LEFT$(D$, 1): PRINT
5100 IF D$ = "N" THEN 6000
5200 IF D$ = "Y" THEN 5500
5300 PRINT "PLEASE ANSWER YES OR NO."
5400 GOTO 5000
5500 PRINT "PLEASE USE "; CHR$(18);
5600 PRINT "DONE"; CHR$(146); " AS THE ";
5700 PRINT "IDENTIFIER AFTER YOU HAVE ";
5800 PRINT "ENTERED ALL OF THE DATA."
5900 PRINT
6000 PRINT "HOW MANY GRADES PER ";
6100 PRINT "STUDENT";: INPUT N: PRINT
6200 PRINT "IF A GRADE IS MISSING FOR ";
6300 PRINT "A STUDENT, PLEASE ENTER A ";
6400 PRINT " 0 (ZERO) FOR THAT GRADE."
6500 R% = 1: R1 = .05
6600 REM SET ROUNDING PARAMETERS
6700 IF D% = 1 THEN R% = 10: R1 = .05
6800 FOR P = 1 TO N: WEIGHT(P) = 1.0: NEXT P
6900 PRINT: PRINT "DO YOU WANT THE ";
7000 PRINT "GRADES WEIGHTED";
7100 INPUT A$: A$ = LEFT$(A$, 1)
7200 IF A$ = "N" THEN 10100
7300 IF A$ = "Y" THEN 7500
7400 PRINT "ANSWER Y OR N.": GOTO 7100
7500 PRINT
7600 PRINT "IT IS ASSUMED THAT THE ";
7700 PRINT "GRADE WEIGHTS WILL TOTAL ";
7800 PRINT "TO NO MORE THAN 100.";
7900 PRINT "IF THE WEIGHTS TOTAL TO ";
8000 PRINT "LESS THAN 100%, THE";
8100 PRINT " PROGRAM ASSUMES THAT YOU ";
8200 PRINT "ARE COMPUTING AVERAGES ";
8300 PRINT "BEFORE THE END OF THE ";
8400 PRINT "TERM AND ADJUSTS THE";
8500 PRINT " WEIGHTS TO YIELD AN ";
8600 PRINT "AVERAGE BASED ON 100%."
8700 PRINT
8800 PRINT "INPUT THE WEIGHTS AS ";
8900 PRINT "PERCENTS.": PRINT
9000 T = 0
9100 FOR I = 1 TO N
9200 PRINT "WEIGHT FOR GRADE "; I; " ";
9300 INPUT WEIGHT(I)
9400 WEIGHT(I) = WEIGHT(I) * .01
9500 T = T + WEIGHT(I)
9600 NEXT I
9700 IF T <= 1.00000001 THEN 10100
9800 PRINT "THE WEIGHTS SUM TO MORE ";
9900 PRINT "THAN 100.": PRINT
10000 GOTO 8800
10100 J = 0
10200 IF D$ = "N" THEN 10700
10300 PRINT: PRINT CHR$(18); "IDENTIFIER";
10400 PRINT CHR$(146);: INPUT NS(J+1)
10500 IF NS(J+1) = "DONE" THEN 16700
10600 GOTO 11200: REM ELSE
10700 IF J = 0 THEN 11200
10800 PRINT CHR$(18); "ANOTHER STUDENT";
10900 PRINT CHR$(146);: INPUT B$
11000 B$ = LEFT$(B$, 1)
11100 IF B$ = "N" THEN 16700
11200 J = J + 1
11300 PRINT "ENTER"; N; "GRADES FOR ";
11400 PRINT "STUDENT "; J
11500 FOR I = 1 TO N

```

```

11600 PRINT "GRADE #";I;
11700 INPUT STUDENT(J,I)
11800 F=STUDENT(J,I)*WEIGHT(I)
11900 AVERAGE(J)=AVERAGE(J)+F
12000 GRADES(I)=GRADES(I)+STUDENT(J,I)
12100 GSQ(I)=GSQ(I)+STUDENT(J,I)^2
12200 NEXT I
12300 IF A$="Y" THEN MD=T
12400 IF A$="N" THEN MD=N
12500 AVERAGE(J)=AVERAGE(J)/MD
12600 PRINT"THE AVERAGE FOR STUDENT ";J;
12700 IF D%=0 THEN PRINT"IS ";AVERAGE(J)
12800 IF D%=0 THEN 13200
12900 A%= (AVERAGE(J)+R1)*R%:REM ROUND
13000 A1=A%/R%
13100 PRINT"IS ";A1
13200 INPUT"OKAY";C$
13300 C$=LEFT$(C$,1)
13400 PRINT
13500 IF C$="Y" THEN 10200
13600 PRINT"WHICH GRADE (IF MORE THAN ";
13700 PRINT"ONE GRADE NEEDS CHANGING, ";
13800 PRINT"YOU MUST REENTER ALL ";
13900 PRINT"GRADES FOR THIS STUDENT.";
14000 PRINT"SIGNIFY THIS BY ENTERING";
14100 PRINT" A # >";N;")"
14200 INPUT RATS
14300 IF A$="N" THEN MD=N
14400 IF A$="Y" THEN MD=T
14500 AVERAGE(J)=AVERAGE(J)*MD
14600 I1=RATS:I2=RATS
14700 IF RATS>N THEN I1=1:I2=N
14800 FOR MIS=1 TO I2
14900 REM Q1 IS A TEMPORARY VARIABLE FOR
15000 REM READABILITY
15100 Q1=STUDENT(J,MIS)
15200 GRADES(MIS)=GRADES(MIS)-Q1
15300 Q1=Q1*WEIGHT(MIS)
15400 AVERAGE(J)=AVERAGE(J)-Q1
15500 Q1=STUDENT(J,MIS)^2
15600 GSQ(MIS)=GSQ(MIS)-Q1
15700 PRINT"ENTER GRADE";MIS;
15800 INPUT STUDENT(J,MIS)
15900 Q1=STUDENT(J,MIS)
16000 GRADES(MIS)=GRADES(MIS)+Q1
16100 Q1=Q1*WEIGHT(MIS)
16200 AVERAGE(J)=AVERAGE(J)+Q1
16300 Q1=STUDENT(J,MIS)^2
16400 GSQ(MIS)=GSQ(MIS)+Q1
16500 NEXT MIS
16600 GOTO 12300
16700 PRINT:PRINT"WHEN YOU ARE READY ";
16800 PRINT"TO SEE THE MEANS, PRESS ";
16900 PRINT CHR$(18);"RETURN";CHR$(146)
17000 GET E$:IF E$="" THEN 17000
17100 PRINT" [CLR]"
17200 PRINT"GRADE ";
17300 PRINT"MEAN ";
17400 PRINT"STANDARD DEVIATION"
17500 FOR K=1 TO N
17600 MP=GRADES(K)/J
17700 MSQ=MP*MP
17800 SP=SQR((GSQ(K)/J)-MSQ)
17900 IF D%=0 THEN 18300
18000 REM ROUND
18100 M%= (MP+R1)*R%
18200 MP=M%/R%
18300 PRINT K,MP,
18400 IF D%=0 THEN 18700
18500 S%= (SP+R1)*R%
18600 SP=S%/R%
18700 PRINT SP
18800 MEAN(K)=MP: SDEV(K)=SP
18900 NEXT K
19000 REM GRAND MEAN AND STD DEV
19100 SUM=0.0
19200 FORM=1 TO J
19300 SUM=SUM+AVERAGE(M)
19400 S2=S2+AVERAGE(M)^2
19500 NEXT M
19600 REM GRAND MEAN
19700 GM=SUM/J
19800 IF D%=0 THEN GP=GM:GOTO 20100
19900 G%= (GM+R1)*R%
20000 GP=G%/R%
20100 PRINT:PRINT"GRAND MEAN = ";GP
20200 DEV=SQR((S2/J)-GM*GM)
20300 IF D%=0 THEN DP=DEV:GOTO 20600
20400 E%= (DEV+R1)*R%
20500 DP=E%/R%
20600 PRINT"STANDARD DEV = ";DP
20700 REM COMPUTE Z SCORES
20800 PRINT:PRINT
20900 PRINT"DO YOU WANT TO SEE THE ";
21000 PRINTCHR$(18);"Z SCORES";
21100 PRINTCHR$(146);:INPUT CS
21200 PRINT:PRINT:PRINT
21300 C$=LEFT$(C$,1)
21400 Q=0
21500 FOR I=1 TO J
21600 ZSC=(AVERAGE(I)-GM)/DEV
21700 IF C$="N" THEN 22300
21800 PRINTI;" ";SPC(6);
21900 Q%=(ZSC+R1)*R%:ZSC=Q%/R%
22000 IF D$="N" THEN 22200
22100 PRINT NS(I),TAB(25);
22200 PRINT ZSC
22300 Z(I)=ZSC
22400 REM Z SCORE FREQUENCIES
22500 FOR K=-3 TO 3 STEP 1
22600 IF ZSC < K THEN 22800
22700 GOTO 23000
22800 COUNT(K+3)=COUNT(K+3)+1
22900 GOTO 23100
23000 NEXT K
23100 Q=Q+1
23200 IF Q<10 THEN GOTO 23700
23300 PRINT:PRINT"PRESS ";CHR$(18);
23400 PRINT"SPACE";CHR$(146);" TO GO ";
23500 PRINT"ON.":Q=0:PRINT
23600 GET E$:IF E$="" THEN 23600
23700 NEXT I
23800 PRINT:PRINT"PRESS ";CHR$(18);
23900 PRINT"SPACE";CHR$(146);" TO GO ";
24000 PRINT"ON.":PRINT
24100 GETZ$:IFZ$="" THEN 24100
24200 PRINT"[CLR]":PRINT
24300 PRINT"FREQUENCIES IN STANDARD ";
24400 PRINT"DEVIATIONS UNITS":PRINT
24500 FOR K=-3 TO 3
24600 PRINT"FREQUENCY FOR ";K;"IS";
24700 PRINT COUNT(K+3)
24800 NEXT K
24900 PRINT:PRINT"PRESS ";CHR$(18);
25000 PRINT"RETURN";CHR$(146);" WHEN ";
25100 PRINT"YOU ARE READY FOR THE ";
25200 PRINT"MENU.":PRINT
25300 GETZ$:IFZ$="" THEN 25300
25400 PRINT:PRINT"THIS PROGRAM HAS ";
25500 PRINT"MAINTAINED THE INPUT DATA ";
25600 PRINT"AND THE COMPUTED VALUES IN";
25700 PRINT" ARRAYS. YOU MAY NOW ";
25800 PRINT"CHOOSE TO EXAMINE ANY OF ";
25900 PRINT"THESE ARRAYS. STUDENT DATA";
26000 PRINT" WILL BE SHOWN IN GROUPS ";
26100 PRINT"OF TEN."
26200 PRINT
26300 PRINTCHR$(18);"1";CHR$(146);
26400 PRINT"STUDENT GRADES"
26500 PRINTCHR$(18);"2";CHR$(146);
26600 PRINT"STUDENT GRADE AVERAGES"
26700 PRINTCHR$(18);"3";CHR$(146);
26800 PRINT"STUDENT Z SCORES"
26900 PRINTCHR$(18);"4";CHR$(146);
27000 PRINT"MEANS AND STANDARD ";
27100 PRINT"DEVIATIONS OF THE GRADES "
27200 PRINTCHR$(18);"5";CHR$(146);
27300 PRINT"FREQUENCIES OF AVERAGES";
27400 PRINT" IN STANDARD DEVIATION UNITS
27500 PRINTCHR$(18);"6";CHR$(146);
27600 PRINT"STOP"
27700 PRINT:PRINT"INPUT THE NUMBER OF ";
27800 PRINT"YOUR CHOICE, BUT DO ";
27900 PRINTCHR$(18);"NOT";CHR$(146);
28000 PRINT" PRESS RETURN.":PRINT
28100 GET Z$:IF Z$="" THEN 28100
28200 U=VAL(Z$):IF U=0 THEN 25400
28300 IF U>3 THEN 28600
28400 ON U GOSUB 29200,30900,32700
28500 GOTO 28700
28600 U=U-3: ON U GOSUB 34600,35400,36100
28700 PRINT:PRINT"PRESS ";CHR$(18);
28800 PRINT"RETURN";CHR$(146);" WHEN ";
28900 PRINT"READY TO CONTINUE."
29000 GET Z$:IFZ$="" THEN 29000
29100 GOTO 26200
29200 REM PRINT GRADES FOR EACH STUDENT
29300 Q=0
29400 FOR I=1 TO J
29500 PRINTI;" ";
29600 IFD$="Y" THEN PRINT NS(I);TAB(20);
29700 FOR K=1 TO N
29800 PRINT STUDENT(I,K);" ";
29900 NEXT K
30000 PRINT
30100 Q=Q+1:IF Q<10 THEN 30700
30200 PRINT:PRINT"PRESS ";CHR$(18);
30300 PRINT"RETURN";CHR$(146);" WHEN ";
30400 PRINT"READY TO CONTINUE."
30500 Q=0:PRINT
30600 GET Z$:IFZ$="" THEN 30600
30700 NEXT I
30800 RETURN
30900 REM PRINT STUDENT AVERAGES
31000 Q=0
31100 IFD$="Y" THEN PRINT"IDENTIFIER";
31200 PRINTTAB(24);"AVERAGE":PRINT
31300 FOR I=1 TO J
31400 PRINTI;" ";
31500 IF D$="Y" THEN PRINT NS(I);
31600 PRINT TAB(24);AVERAGE(I)
31700 Q=Q+1:IF Q<10 THEN 32500
31800 PRINT:PRINT"PRESS ";CHR$(18);
31900 PRINT"RETURN";CHR$(146);" WHEN";
32000 PRINT" READY TO CONTINUE."
32100 Q=0:PRINT
32200 GET Z$:IFZ$="" THEN 32200
32300 IF D$="Y" THEN PRINT"IDENTIFIER";
32400 PRINTTAB(24);"AVERAGE":PRINT
32500 NEXT I
32600 RETURN
32700 REM Z SCORES
32800 REM OF THE GRADES
32900 Q=0
33000 IF D$="Y" THEN PRINT"IDENTIFIER";
33100 PRINTTAB(24);"Z SCORE":PRINT
33200 FOR I=1 TO J
33300 PRINTI;" ";
33400 IF D$="Y" THEN PRINT NS(I);
33500 PRINT TAB(24);Z(I)
33600 Q=Q+1:IF Q<10 THEN 34400
33700 PRINT:PRINT"PRESS ";CHR$(18);
33800 PRINT"RETURN";CHR$(146);" WHEN";
33900 PRINT" READY TO CONTINUE"
34000 Q=0:PRINT
34100 GET Z$:IF Z$="" THEN 34100
34200 IF D$="Y" THEN PRINT"IDENTIFIER";
34300 PRINTTAB(24);"Z SCORE":PRINT
34400 NEXT I
34500 RETURN
34600 REM MEAN AND STANDARD DEVIATIONS
34700 REM OF THE GRADES
34800 PRINT"GRADE ";"MEAN ";"ST.DEV"
34900 PRINT
35000 FOR I=1 TO N
35100 PRINT I,MEAN(I),SDEV(I)
35200 NEXT I
35300 RETURN
35400 REM FREQUENCY DISTRIBUTION
35500 PRINT
35600 FOR K=-3 TO 3
35700 PRINT"FREQUENCY FOR ";K;"IS";
35800 PRINT COUNT(K+3)
35900 NEXT K
36000 RETURN
36100 PRINT"REALLY STOP (Y/N)?"
36200 GET Z$:IFZ$="" THEN 36200
36300 IF Z$="N" THEN 25800
36400 PRINT"THIS IS THE END OF THE ";
36500 PRINT"PROGRAM."
36600 END
36700 GOTO 24900

```

Announcement:

Curriculum Development Project for High School Computer Science

The National Science Foundation and the University of Tennessee are developing a school computer science curriculum for the 1980's. The curriculum:

- is based on color graphics on microcomputers;
- uses the PASCAL language;
- is designed for the general audience rather than "science-track" students.

Questions:

1. When will the Curriculum be available to the public?
 - National distribution will begin in Spring 1982.
 - Twelve test schools in the Southeast will use the Curriculum in 1981.
2. What will the Curriculum actually be like?
 - The basic idea is to use graphics, rather than numbers, as the fundamental "product" of computing. Designed for use by approximately 15 students per computer (in a single class), the curriculum includes programs, lesson plans, structured exercises, games, contests, and workbook material. Every effort is directed toward avoiding "math anxiety" and the "computer mystique".
3. Could my school be one of the twelve test schools?
 - Yes, if:
 - your school is within 400 miles of Knoxville, Tennessee;
 - you have, or will acquire, one or more microcomputers of a type* compatible with the software being used by the project;
 - one of your teachers can attend a one-week workshop in Knoxville during the summer of 1982 (expenses paid by NSF).
 - It is not necessary that your school have been teaching computing prior to 1982; we want some schools that have, and some that haven't.

Time-Line:

- 1 July 1980: Deadline for Application to be a Test School
- 1 Oct. 1980: Schools are selected from among the applicants
- January 1981: Site visits to selected schools; planning for student enrollment in the following Autumn course.
- Summer 1981: Workshop for teachers
- Autumn 1981: The course begins (1 semester course; teach it twice in the year).

For further information, contact:

Michael Moshell, Director
 High School Computer Science Project
 Computer Science Department
 University of Tennessee
 Knoxville, TN 37916

©

*Our primary development system is the APPLE computer; it is also possible that "S-100" computers such as IMSAI will be used.

New York Area Educators Note:

Computers and "software" for classroom use can be tried out by New York area teachers and school administrators at Teachers College/Columbia University's new Microcomputer Resource Center, the first program of its kind in the Northeast.

The Microcomputer Resource Center, which opened November 1, is a free service to educators confronted with the sudden popularity of computers in elementary and secondary schools. It features three microcomputers frequently purchased by schools and a cassette library of educational programs written by local teachers as well as those published by computer companies. Among the specially designed materials are a baseball game that pitches arithmetic problems, a bowling game that teaches decimals, and a dart game that is scored by a student's speed in estimating round numbers.

Karen Billings, director of the Microcomputer Resource Center, explained that it was organized because "computers, already in homes and business, are coming to the field of education, and teachers need a place to learn about them."

Many schools began purchasing microcomputers about two years ago, she continued, when technology reduced the price and size of computers to \$2,000 and less for a tabletop model. Although originally acquired for mathematics classes, the machines are now being used for all academic subjects; simulated chemistry experiments and geography drills, for example, are on cassette in the Center library.

A qualified staff member, who already has taught with computers in his or her classroom, is on hand at the Microcomputer Resource Center to introduce the novice to the equipment. Teachers experienced with computers also are welcome to experiment with materials and meet with colleagues interested in improving microcomputer services in their schools. The Center contains a growing collection of books and periodicals relating to computers in education.

The Microcomputer Resource Center is open Monday through Thursday, 5 to 7 p.m., in Room 655G Thorndike Hall at Teachers College, 525 West 120th Street, New York, New York 10027. Educators are welcome to walk in on a first-come-first-served basis or to call 212-678-3740 for an appointment.

©

Microphys Programs

Dear Educator:

Microphys is pleased to introduce its series of computer programs which have been specifically designed for use on the Commodore 8K PET and 16/32K CBM microcomputers. These programs have readily enabled instructors to provide their students with an opportunity to review, in an interesting and effective manner, the important concepts encountered in introductory courses in chemistry, physics, mathematics, vocabulary, and spelling.

Please note that the vast array of software programs, which have been **uniquely** designed for use on the PET microcomputer, will readily enable you to use the microsystem in your courses as soon as it arrives. The programs are available on cassette tapes and arrive complete with full instructions for their immediate use even by those who have little, if any, experience with the use of the computer itself.

There are three types of programs in the Microphys series:

- I. **Computer-Assisted Instruction Programs** guide the student through a series of quantitative questions; the student interacts with the computer and receives immediate evaluation of his responses and/or assistance when needed. Each time a particular program is run, a different set of numerical data is generated. In most instances, an entirely new problem is presented.
- II. **Individualized-Instruction Programs** generate a unique set of problems for each student. The essential information needed to solve each problem is recorded and, when he is ready to do so, the student may obtain the computer's answers and compare his results. These answers may be suppressed by deleting line number 8500 in any program. When now run, a unique set of problems is produced for each student who records the essential information along with his code number which is generated by the computer. When his work is completed, the student enters his code number and answers into the program which had given him his assignment. The computer will then grade his work, displaying the answers to those problems which were

incorrectly solved; a percent score and a brief comment reflecting an overall evaluation are also given.

- III. **Utility Programs** are designed to provide solutions to time consuming problems often given on exams or homework assignments. Problems in calorimetry, stoichiometry, projective motion, vector analysis, etc. require tedious computation. These utility programs free teachers from the time required to obtain the correct solutions. Students may also be permitted access to these programs in order to check their own work.

Please note that each physics and chemistry program has both the computer-assisted instruction and individualized instruction versions recorded on opposite sides of the cassette. The vocabulary programs are similarly designed; the computer assistance being rendered by providing the student with a sentence in which the word to be defined is used properly. With this contextual clue, the student is again asked to correctly select the proper definition. The math cassettes have only an individualized-instruction mode.

Microphys has released its educational software on floppy diskettes designed for use on the Commodore 2040 dual drive floppy disk unit. Each diskette is accompanied by complete instructions for those programs recorded upon it. Write for details.

Microphys programs are available from local computer dealers. If your dealer does not carry the programs, you should encourage him to contact Microphys directly, or the Microphys distributor serving the geographic area. You may of course order software directly from Microphys if programs are not obtainable locally.

An educational software catalogue, describing the nature of the various programs listed below, is available from Microphys.

Note: Please indicate whether you desire the 8K or 16K version of a given program when placing an order.

The cost of each cassette is \$20.

Chemistry and Physics Cassettes

1. Linear Kinematics
2. Projectile Motion*
3. Momentum and Energy*
4. Energy and the Inclined Plane
5. Inelastic Collisions
6. Centripetal Force
7. Pulley Systems — Machines*
8. Specific Heat Capacity
9. Calorimetry
10. Heats of Fusion/Vaporization
11. Specific Gas Laws
12. General Gas Law
13. Thermodynamics I
14. Thermodynamics II
15. Transverse Standing Waves
16. Longitudinal Standing Waves
17. Lenses and Mirrors*
18. Refraction of Light
19. Series Circuit Analysis
20. Parallel Circuit Analysis I
- 20A. Parallel Circuit Analysis II
21. Series/Parallel Circuit Analysis*
22. Faraday's Law
23. Gram-Molecular Mass
24. The Mole Concept*
25. The Molarity Concept*
26. The Normality Concept
27. The Molality Concept
28. Stoichiometry: Mass/Mass
29. Stoichiometry: Mass/Volume
30. Stoichiometry: Volume/Volume
31. Stoichiometry: General*
32. Percent Concentration
33. pH Concept
34. EMF of Electrochemical Cells
35. Electric Field Analysis
36. Photoelectric Effect
37. Symbols and Valence Drill
38. Formulas of Compounds Drill*
40. Total Internal Reflection

DEALER INQUIRIES INVITED

Vocabulary Cassettes

401. 12th Grade I
402. 12th Grade II
403. 12th Grade III
404. 12th Grade IV
405. 12th Grade V
406. 11th Grade I
407. 11th Grade II
408. 11th Grade III
409. 11th Grade IV
410. 11th Grade V
411. 10th Grade I
412. 10th Grade II
413. 10th Grade III
414. 10th Grade IV
415. 10th Grade V
416. 9th Grade I
417. 9th Grade II
418. 9th Grade III
419. 9th Grade IV
420. 9th Grade V
421. 8th Grade I
422. 8th Grade II
423. 8th Grade III
424. 8th Grade IV
425. 8th Grade V
426. 7th Grade I
427. 7th Grade II
428. 7th Grade III
429. 7th Grade IV
430. 7th Grade V

Spelling Cassettes

601. Spelling I Grade 12
602. Spelling II Grade 12
606. Spelling I Grade 11
607. Spelling II Grade 11
611. Spelling I Grade 10
612. Spelling II Grade 10

Math Cassettes Senior High School

701. Quadratic Equations
702. Trigonometry I
703. Simultaneous Equations (2x2)
704. Simultaneous Equations (3x3)
705. Geometrical Areas
706. Trigonometry II
707. Verbal Problems I — Numbers
708. Verbal Problems II — Coins
709. Verbal Problems III — Ages
710. Verbal Problems IV — Interest
711. Verbal Problems V — Mixtures
712. Verbal Problems VI — Geometry
713. Verbal Problems VII — Rates
714. Verbal Problems VIII — Digits
715. Verbal Problems IX — Work
716. Arithmetic Progressions I
717. Arithmetic Progressions II
718. Geometric Progressions I
719. Geometric Progressions II
720. Types of Variation
721. Linear Equations
722. Formula Evaluation
723. Coordinate Geometry I
724. Exponents and Logarithms
725. Verbal Problems — General

Math Cassettes Junior High School

801. Magic Squares
802. Multiplication
803. Division
804. Modular Arithmetic
805. Proportion Problems
806. Percent Problems
807. Addition of Fractions
808. Subtraction of Fractions
809. Multiplication of Fractions
810. Division of Fractions
811. Mode, Median, and Mean
812. Bar Graph Analysis
813. Decimals I
814. Decimals II
815. Verbal Problems I

Utility Cassettes

301. Vector Analysis I
302. Vector Analysis II
303. Gas Law Analysis
304. Optics Analysis
305. Projectile Analysis
306. Calorimetry Analysis
307. Chemistry I Analysis
308. Chemistry II Analysis
309. Stoichiometry Analysis

NEW 350. Cryptogram Generator/Decoder

Microphys Programs
2048 Ford Street
Brooklyn, New York 11229
(212) 646-0140

616. Spelling I Grade 9
617. Spelling II Grade 9
621. Spelling I Grade 8
622. Spelling II Grade 8
626. Spelling I Grade 7
627. Spelling II Grade 7

WHY IS CURSOR™ SO GOOD?

A Special Thanks to
Our Talented Authors:

Howard Arrington
Gary Bainbridge
Chuck Bond
Chuck Cares
Hal Carey
Art Carpet
Sheila Dolgovich
Ralph Dufour
Greg Erker
Glen Fisher
Gary Flynn
John Fox
John Grove
Julia Hallford
Mike Hamilton
Mark Heaney
James Hinds
Ken Kasmar
George Leotti
Randall Lockwood
Martin Mabee
David Malmberg
Tom Marazita
John Matarella
Ken Matthews
John Melissa
Malcolm Michael
Ken Morley
Christopher Nadovich
Norman Parron
Mark Pelczarski
Larry Phillips
David Platton
Donald Ross
Herb Sandy
Brian Sawyer
Tony Schettino
Larry Stevens
Theodor Wagner

Maybe it's because we've always had high standards. Beginning with our first issue in July, 1978, we've published some 80 programs in our first 16 issues. Plus 16 animated graphic "Front Cover" programs. That's a lot of programs, a lot of code. Each program has been extensively edited by Glen Fisher, our Editorial Director. The result is obvious: Cursor programs reflect professional standards. We're proud of every program we publish.

But there's something else, too.

It's imagination. Our subscribers continue to be delighted with the new, fresh programming ideas that Cursor provides. Some of the best graphic animations for the Pet have appeared in Cursor. Teachers love us! They use Cursor as an example of what can be done on a Pet, with some skill and imagination.

Finally, there's service. Orders for single issues are almost always shipped within 24 hours. New subscriptions are processed within five working days. Should you get one of our rare defective tapes, just return it for an immediate replacement. And of course you can cancel your subscription at any time and we'll gladly refund all remaining issues.

Cursor: Quality. Imagination. Service.

For only \$3.95 you can buy a sample issue and judge for yourself. Or send \$20 for a six-issue subscription. You'll get six C-30 cassettes, each with five programs and a Front Cover ready to LOAD and RUN. With each issue you also get our Cursor NOTES, a lively commentary on the industry, as well as documentation for the programs.



Pet is a trademark of
Commodore Business Machines, Inc.

ORDER FORM

_____ Sample Copy of Cursor \$3.95 (California residents add 6% tax)
_____ 6 issues for \$20 (US & Canada. US Funds.)

Name _____

Address _____

City _____ State _____ Zip _____

VISA MasterCharge Expires: _____

Card Number: _____ Signature: _____

CURSOR
Box 550
Goleta, CA 93017
Phone: 805-967-0905

**The Code
Works™**

A MICRO FOR THE TEACHER

Thorwald Esbensen

Coordinator of Elementary Curriculum
and Instruction, Edina Public Schools
Edina, Minnesota 55435

Edina, Minnesota, is a relatively conservative community in the Minneapolis/St. Paul metropolitan area. A year ago last spring, the Edina School System had one microcomputer. Today it has fifty-one (forty-eight of which are PET COMMODORE machines).

How did it happen? What is currently going on? What are prospects for the future? Answers to these questions are the point of this article.

New ways of doing things are not created in a vacuum. In Edina, certain factors helped establish a favorable climate:

1. Our supervisor of media services was interested in exploring this area of instructional technology.
2. The superintendent was supportive.
3. The school board was receptive.

Given these circumstances, the author, who had weathered an ill-starred love affair with teaching machines during the 1960's, began to feel once again the stir of passion. A new commitment was born.

A decision was made to start at the elementary school level with regular classroom teachers. This was an important moment.

A terrible myth has grown concerning the use of computers. In essence, it assumes that "math types" are the chosen people to operate electronic marvels. Hardly surprising.

Unreconstructed humanists have helped the fallacy along. They have taken an almost perverse pride in their inability to distinguish a "byte" from a hole in the ground, perhaps hoping in this way to ward off that final and unspeakable event - the human soul ravished by a machine.

Those among us who inordinately love numbers and circuits have also encouraged the myth. And why not? Having little mysteries is good for the image of any occupational group. It lends a bit of class to the calling.

But it is divisive. And the field of education cannot afford that luxury these days. So it became

important to push microcomputers within a setting that clearly showed these new wonders to be suitable for educators innocent of mathematics.

Our first placement of a microcomputer was with a first grade teacher. It was assigned to her for whatever use she wished to make of it on a daily basis within her regular classroom.

Of course, there were assurances of program support. As a good faith gesture, the author pledged to teach himself programming so that the commercial market place would not have to be relied on as the major source of instructional tapes.

Several books were acquired that purported to teach BASIC to novices in the field of microcomputing. Of these, the best (from the author's point of view) was Instant Basic, by Jerry Brown. For about three months, approximately thirty hours per week on evenings and weekends were devoted to learning BASIC. At the end of this time, programs began to be created that would actually function with real students in real classrooms. Since then, the author has continued to study and write, and finds the whole business remarkably exciting.

Would Edina's teachers respond enthusiastically to microcomputers? To encourage an affirmative answer, two-day summer workshops were organized for interested staff members, and college credit was available to the participants. Although an introduction to beginning programming was given, the main purpose of these workshops was to give teachers a chance to SHAKE HANDS WITH A MICRO.

A good deal of time was spent running programs already acquired by the district's media services center. Each participant had an individually assigned microcomputer to use, and this kind of accessibility made it easy to see that today's popular microcomputers are, indeed, friendly machines.

A second kind of microcomputer workshop was organized for teachers who had attended the two-day sessions. This workshop was scheduled for four hours per day for five days. The main purpose

was to acquaint teachers with ANSWER BOX, a program written by the author to enable non-programmers to prepare print-integrated computer programs of their own choosing.

Here is a brief explanation of how ANSWER BOX works:

The program assumes that a student will bring printed exercises to the computer. The printed material presents the problems. The student responds to each problem by entering the answer on the computer keyboard. The computer thus becomes a sophisticated response device, providing immediate reinforcement, keeping track of student progress, and monitoring the amount of time on task.

The key to ANSWER BOX is programming that requires only the clerical skill of typing answers on data lines. Once teachers perceive that nothing more than simple typing is necessary in order to prepare programs, an attitudinal sea-change often takes place. On the basis of this kind of workshop alone, several of our teachers have put substantial portions of their instructional materials into the print-integrated format supplied by ANSWER BOX.

No questions of copyright are involved. Nothing in the original printed material is copied or altered in any way. The answers to problems are simply entered into the computer on the appropriate data lines. The computer does the rest.

A third kind of workshop has now been instituted. This one is for teachers who wish to go beyond ANSWER BOX into composing problems as well as answers to be entered into the computer. Again, the simple skill of typing on data lines is all that is required. But the pleasure shown by teachers who have in this sense written their own computer programs is most rewarding.

A fourth kind of workshop is envisaged. This one would assist teachers who might want to do some educational programming from scratch. There probably won't be many at first. But this is the sort of thing that can develop gradually as time goes on.

So what is currently going on?

Back briefly to that first grade teacher with whom we had placed Edina's first microcomputer. It took her children only one day to familiarize themselves with the PET. After that, they were off and running programs.

From that beginning, only 1½ years ago, our use of classroom-based microcomputers has grown by leaps and bounds. And the demand is now being generated and sustained by the classroom teachers themselves. In an era of budget cutting, to have school principals commit their own relatively meager building funds for the purchase of more

(and still more) microcomputers - well, this tells you something pretty important about educational priorities along that front line where children are actually being taught.

This year, Edina is using the microcomputer to give special assistance to elementary school students who have done poorly on the Iowa Tests of Basic Skills. In particular, the author has written programs in the areas of spelling, capitalization, punctuation, and usage. These are now being used to help children upgrade their performance on standardized achievement tests. Four of Edina's elementary schools have established student support centers with full-time paraprofessionals to aid in the accomplishment of this goal. A major engine of instruction in these student support centers is the microcomputer.

Recently, there has been considerable talk in educational circles about the need for mastery learning. Books have been written on the subject, and various activities in support of the concept are underway across the country. The most visible example of this has been the widespread interest in competency-based testing. That microcomputers have not as yet been widely viewed as applicable to this effort can only be due to the fact that school people, in general, have not yet grasped the educational implications of the microcomputer revolution.

But this situation will change. It is changing. Ludwig Braun, Professor of Engineering and Assistant Director of Educational Technology of the National Coordinating Center for Curriculum Development, State University of New York at Stony Brook, in a report prepared for the National Institute of Education, put the matter this way:

“‘We see through a glass, darkly,’ the Scripture writer said. It is difficult also to predict the character of the classroom a decade hence, or the role of the computer in it. It is difficult even to predict what this computer will be able to do, or how much it will cost, in view of the dizzying pace of developments since January, 1975.’” (Braun is referring here to the computer revolution that was initiated then by the introduction of the Altair 8800 microcomputer.)

“‘The microcomputer era upon which we are embarking already has been characterized as the era of the personal computer. It certainly will be that, but it promises to be much more. Educational and social historians someday may look upon January, 1975 as the start of the time when the computer enabled humans to expand their intellectual powers beyond our present comprehension.’”

Or, in the immortal words of Al Jolson: “‘You ain't seen nuthin' yet!’”

Light-Pen Selection From Large Menus on the PET/CBM Screen

David R. Heise
14 Davie Circle
Chapel Hill, NC 27514

This program shows how to write a large menu on the PET/CBM screen and then make selections from it using 3G Company's light-pen. The menu is constructed so that up to 90 items are presented in alphabetic or numerical order, descending within four columns. Light-pen selections that pass error checks are flagged on the screen by reverse printing. An erase routine permits the user to change his or her mind.

This particular program tallies classroom attendance records, but other kinds of outcomes could be obtained by adding a different subroutine at the end.

Key subroutines are positioned near the top of the program and are jammed onto lines in order to minimize response time during light-pen selection: response time is two seconds with the maximum of ninety items. Error checks are quite successful in preventing wrong selections even though touch points for the light-pen are on adjacent lines.

The program has been listed on an ASCII printer using B. Seiler's transliteration routine, given in Commodore's PET USERS CLUB NEWSLETTER, Vol. 1, #6. The structure of the program can be seen in the first nine statements.

Program initialization A poke sets lower case instead of graphics and another poke speeds up screen printing. Several strings are prepared for use in scanning.

Port initialization This was provided by 3G Company as part of the software accompanying their light-pen.

Obtain Menu Entries Items to be listed in the menu are read from a tape or disk file. (If on disk, the file name should be entered in the format "dr:filename".) Each item except the last should be followed by a carriage return. The following is an example of how to produce a proper tape file (N is the number of entries).

```
10 N =
20 OPEN 1,1,1, "ITEMS"
30 FOR I = 1 TO N-1
40 INPUT A$
50 PRINT #1, A$ CHR$(13);
60 NEXT I
70 INPUT A$
80 PRINT #1, A$;
90 CLOSE 1
```

Items are truncated to seven characters. Two command items -- ERASE and DONE -- are added to the end of the list.

Create Menu The menu construction routine arranges the items into four columns of minimum length. The command items are presented at the end in reversed lettering.

Find Choices Touch points are indicated by a small cross following each item. The selection routine sweeps a white square over these points. Whenever a signal is produced in the light pen, the square stops and blinks a couple of times to make sure that it is the source of the signal (a 3G Company subroutine is used for this). Blinks are tried below and above the position to make sure that the square is at the point where the pen is touching rather than at an adjacent point.

Having found a selection, the program transfers to another subroutine where a one (instead of zero) is entered into array CH% in order to record the item that has been chosen. The item name is written in reversed lettering to show the user that the selection is accomplished. Then the program returns to scanning the touch points.

Selecting the command item, ERASE, causes the word "erase" to appear at the bottom of the screen. This indicates that the next selection will operate in reverse: zero is recorded in the CH% array and the item name is rewritten without reversed lettering. The word "erase" disappears after a correction has been made, and operation returns to the normal mode.

Selecting the command item, DONE, moves the program to the routine where results are produced. The CH% array carries along the information about what items were selected.

Produce Results The listed program takes student names as the menu items. The light-pen is used to tick off attendance at each class from sign-up sheets. Having finished with one sign-up sheet, the user selects DONE, then presses SPACE to get a fresh menu for the next sign-up sheet. When all data have been entered, the user presses @ rather than SPACE. The program figures out which students have cut classes three or less times and prints their names on the screen.

CAUTION!

USE OF SOFTPAC-1 MAY BE HABIT FORMING

We would like to announce a NEW STANDARD in Software Packaging! With SOFTPAC-1 we are combining QUALITY software with BACK-UP COPIES on all serious programs. There is a sheet describing how to ADD SOUND to your PET or CBM for \$13! Some of the programs include SOUND in them. The Floppy version has a animated DEMO program which allows 1 key loading of any program of your choice. From the programs you can automatically return to the DEMO, to choose a different program! You get 18 Programs on Disc or 17 Programs on Cassette. The difference is you get TWO Discs or TWO Cassettes with the SAME programs for redundancy in PROTECTING YOUR Investment! A clear vinyl page holds the discs and cassettes. This all comes packaged in a Strikingly Silk-Screened, virtually indestructible NOTEBOOK! We Sincerely feel that you will be so impressed with the High Quality Software and package, that we are offering a 10 day Return Privilege! See disclaimer at bottom of Ad. This package will RETAIL in stores at \$34.95, but for a LIMITED time to COMPUTE READERS we will make the following offer:

**FOR \$29.95 + \$1 Shipping
YOU GET ALL THIS!**

Silk-Screened Notebook
Vinyl Pocket Page
18 PGMS on Master & Backup Discs!
or
17 PGMS on Master & Backup Cassettes!
18 Pages Text & PGM Listings!
First Class Delivery From Stock!
10 Day Money Back Return Privilege!
All Our Best Selling Software!

“SOFTPAC-1F” “01

“TANK-16K”	“DEMO”
“QUIZ MASTER DEMO”	“MEMORY TEST”
“QUIZ MASTER PGM”	“CHASE”
“BIORHYTHM”	“BREAKOUT”
“HOME UTIL.V4”	“OTHELLO”
“MPG”	“OTHELLO/2”
“LOANS 1 & 2”	“STRATEGY”
“ELECTRICITY”	“BOUNCE”
“SAVINGS”	“TANK”

These programs run in ALL PET/CBMs! We accept MASTERCARD & VISA. Send Account Number, Interbank Number, Expiration Date and SIGN your order. Please Specify FLOPPY DISC or CASSETTE Version, and which computer you own, and whether you have a Business or Graphics.

COMPETITIVE SOFTWARE
21650 MAPLE GLEN DR.
EDWARDSBURG MI 49112



IMMEDIATE REFUND minus Shipping upon receipt of package within 18 days of shipment. Enclose reason for return in package.

```

10 REM LIGHT-PEN MENU (UP TO 90 ITEMS). D. HEISE
20 GOSUB 460: REM INITIALIZE PROGRAM
30 GOSUB 560: REM INITIALIZE PORT
40 GOSUB 630: REM OBTAIN MENU ENTRIES
50 GOSUB 800: REM CREATE MENU
60 GOSUB 940: REM FIND CHOICES
70 GOSUB 1010: REM PRODUCE RESULTS
80 IF AS=" " THEN 50: GET MORE INPUT
90 END
100 REM ***** SUBROUTINES
110 REM 3G CO. LIGHT PEN ROUTINE
120 P=0:FORJ=1TO2:PRINTOFS;
130 FOR W=1 TO 25: NEXT W
140 POKE LP,4
150 POKE LP,6
160 FOR W=1 TO 5:NEXT W
170 IF PEEK(LP)=6 THEN RETURN
180 PRINTLS;
190 FOR W=1 TO 25:NEXT W
200 IF PEEK(LP)=7 THEN RETURN
210 NEXTJ:P=1:RETURN
220 REM CHECK FOR A CHOICE
230 GOSUB120:PRINT"<>";:IF P=0 THEN RETURN
240 PRINT"<Q>";:GOSUB120:IF I=CL THEN PRINT "<>";:GOTO 260
250 PRINT"<>";
260 IF P=1 THEN P=0:PRINT"<q>";: RETURN
270 PRINT"<q><q>";:GOSUB120:IF I=1 THEN PRINT "<>";:GOTO 290
280 PRINT"<>";
290 IF P=1 THEN P=0:PRINT"<Q>";: RETURN
300 PRINT"<Q>";:P=1:RETURN
310 REM FOUND A CHOICE
320 P=0
330 IF E=1 THEN E=0:GOTO 410
340 IF M<>IR-1 THEN 380
350 FOR K=0 TO 4: READ Z: POKE 33728+K,Z:NEXT K
360 E=1
370 RETURN
380 CH%(M)=1
390 PRINT"<R>"CLSMUS(M)"<r><>";
400 RETURN
410 CH%(M)=0
420 PRINTCLSMUS(M)"<r><>";
430 FOR K=0 TO 4: READ Z: POKE 33728+K,Z:NEXT K: RESTORE
440 RETURN
450 DATA 197,210,193,211,197,32,32,32,32,32
460 REM INITIALIZE PROGRAM
470 POKE59458,62:REM SPEED PRINTING
480 POKE59468,14:REM SMALL LETTERS
490 REM CURSOR RIGHT, CURSOR LEFT, AND SPACER STRINGS
500 FOR I=1 TO 39: CRS=CRS+"<>":NEXT
510 FOR I=0 TO 3: CRS(I)=""<S><Q>"<LEFT$(CRS,10*I+8): NEXT I
520 FOR I=1 TO 8: CLS=CLS+"<>": SPS=SPS+" ": NEXT
530 OFS=""<>":LTS=""<R><r><>": REM BLINKERS
540 I1=1: I2=2: I6=0: REM CONSTANTS
550 RETURN
560 REM 3G CO. ROUTINE TO INITIALIZE PEN AND PORT
570 POKE 59459,254
580 LP=59471
590 POKE LP,4
600 POKE LP,6
610 P=0
620 RETURN
630 REM READ IN MENU ENTRIES
640 DIM MUS(100), CH%(100), DT(100)
650 INPUT"<s>INPUT NAME OF FILE CONTAINING LIST ITEMS";FFS
660 DV=1:CN=0
670 IF MIDS(FFS,2,1)="" THEN DV=8: CN=5: FFS=FFS+"S,R": GOTO 710
680 PRINT"<s>REWIND DATA TAPE.
690 PRINT"PRESS <R>SPACE<r> WHEN READY.
700 GET AS: IF AS="" THEN 700
710 OPEN 1,DV,CN,FFS
720 IR=IR+1
730 IF ST=0 THEN INPUT#1,MUS(IR): GOTO720
740 CLOSE 1
750 MUS(IR)=""<R>ERASE<r> "
760 IR=IR+1
770 MUS(IR)=""<R>DONE <r> "
780 FOR I=1 TO IR-2: MUS(I)=LEFT$(MUS(I)+SPS,7):NEXT
790 RETURN
800 REM CREATE MENU CHART
810 PRINT"<s>
820 CL=INT((IR+3)/4)
830 FORI=1 TO CL
840 K=0
850 FOR J=0 TO IR STEP INT((IR+3)/4)
860 K=K+1
870 IF K>4 THEN 900
880 IF I+J>IR THEN PRINT " ",:GOTO 900
890 PRINT MUS(I+J),
900 NEXTJ

```

```

910 IF K<4 THEN PRINT " "
920 NEXTI
930 RETURN
940 REM SCAN MENU
950 M=0:FORJ=0 TO 3:PRINTCRS(J);:FORI=1TOCL:PRINT"<R><r><>";
960 M=J:CL+I
970 IF M>IR THEN PRINT "<>";: NEXT I,J: GOTO 950
980 P=0
990 IF PEEK(LP)=16 THEN GOSUB 230: IF P=1 THEN GOSUB310: IF M=IR THEN
RETURN
1000 PRINT"<><Q>";:NEXTI,J:GOTO950
1010 REM PRODUCE RESULTS
1020 REM THIS PROGRAM IS SET UP TO TALLY SCHOOL ATTENDANCE
1030 REM STUDENT NAMES ARE READ FROM A TAPE OR DISK FILE
1040 REM ATTENDANCE DATA FROM SIGN-UP SHEETS ARE ENTERED THROUGH
THE SCREEN
1050 REM OUTPUT: NAMES OF STUDENTS WHO HAVE CUT 3 OR FEWER TIMES
1060 NS=NS+1
1070 FOR I=1 TO IR-1
1080 IF CH%(I) THEN DT(I)=DT(I)+1
1090 NEXT
1100 PRINT"<s>PRESS SPACE TO DO ANOTHER LIST.
1110 PRINT"PRESS <R>@<r> TO GET FINAL TALLY.
1120 GET AS: IF AS="" THEN 1120
1130 IF AS="" THEN RETURN
1140 PRINT"<s><R>STUDENTS WITH ATTENDANCE CREDIT:
1150 FOR I=1 TO IR-2
1160 IF NS-DT(I)>3 THEN 1180
1170 PRINT MUS(I),
1180 NEXT I
1190 GOTO 1190
1200 RETURN

```

©

6502 COMPILERS

— PET OR SYM GRAPHICS COMPILER —

- Produces 6502 object code used to draw graphics characters on CRT; easier and faster than BASIC.
- Object code can be run without compiler or can be combined with BASIC programs.
- 35 commands — additional commands may be added by user.

— PET MUSIC & SOUND COMPOSER —

- Produces 6502 OBJECT CODE used to compose musical songs or those special sound effects.
- Four octaves of musical notes including sharps and flats — Tempo & beat variable.
- 24 other commands.

Both compilers require the use of EHS's Macro assembler and text editor (ASSM/TED), and provides a new command: >BUILD MACROS and >BUILD LIBRARY that is useful for other functions. Also, an enhancement which provides for 31 characters per label is included.

Cassette and Manual \$29.95 (U. S. postage included)

Please specify compiler desired)

Eastern House Software

3239 Linda Dr.

Winston-Salem, N. C. 27106

Phone [919] 748-8446 or 924-2889

THE CONSUMER COMPUTER

Len Lindsay

Welcome back aboard the Consumer Computer. We will continue with product reviews, announcements, and just plain rumors. Please let me repeat my warning to all home computerists:

DO NOT BUY ANY COMPUTER PRODUCT UNLESS YOU ARE SURE IT EXISTS!!
Now on with business. Lets start off with ATARI news.

Atari Software

Another software company has announced that they will be supporting the ATARI with ready to RUN software. IMAGE COMPUTER PRODUCTS (615 Academy Drive, Northdale, IL 60062) is producing 6 software tapes for the ATARI. ALL STAR BASEBALL (6401) will work on both 8K and 16K ATARIs with joystick use optional. It is a two player game. WALL STREET CHALLENGE (6402) for both 8K and 16K, offers you the chance to invest and speculate in the stock market. MIND MASTER (6403) is a computerized version of MasterMind tm allowing several players to act as either code maker or code breaker. STRATEGY PACK I (6404) includes the classic game of CHECKERS as well as FRAME UP, a numbers game with optional joysticks. STRATEGY PACK II (6405) includes TARGET CHASE for 1 or 2 players, TUNNELS, a hide and seek game, SURVIVAL where you must maneuver to survive against your opponent, and SNAKE HUNT, another two player quick response game, with optional joystick use. SKILL BUILDER I (6406) includes BINGO DUEL for one or two players and NUMBER HUNT which requires joysticks.

Prices and introduction dates are not available, but I hope to have more info next issue. Watch for the reviews soon.

PET BOOKS

Osborne (630 Bancroft Way, Berkeley, CA 04710) has just published the 6502 ASSEMBLY LANGUAGE PROGRAMMING book, and it looks very good indeed (see Jim Butterfields review last issue). Watch for their PET PERSONAL COMPUTER GUIDE due to hit the shelves in March and PET AND THE IEEE 488 BUS new in February 1980. I am sure they will keep up Osborne quality tradition.

Cow Bay Computing (Box 515, Manhasset, NY 11030) is selling three books which should be of interest to computing teachers. Two are workbooks for students. They should prove ideal in any computer literacy class or program. FEED ME, I'M YOUR PET COMPUTER is very fundamental

and for very beginners. LOOKING GOOD WITH YOUR PET is for advanced beginners in computer programming concepts.

The PET is a good computer to use in a computer literacy course, and the two workbooks are good aids to any such course. They also have an answer book appropriately titled THE TEACHERS PET. It is more than just an answer key however, since it also briefs the teacher on the concepts and vocabulary used with each lesson.

Sams (4300 W 62nd ST., PO Box 7092, Indianapolis, IN 46206) has announced two new books for 1980 - 6502 SOFTWARE DESIGN and PROGRAMMING & INTERFACING THE 6502. Both should be good books for any serious 6502 programmer.

DYMAX (Box 310, Menlo Park, CA 94025) is presently coordinating a series of over 10 books including 4 for the PET. More details on these soon.

Dan Isaacson (Computers in Education, University of Oregon, Department of Computer Science, Eugene, OR 97403) has published a LARGE guide for using the PET to introduce microcomputers to TEACHERS. The book is in a three ring binder and titled: DISCOVER THE MICROCOMPUTER AS AN INSTRUCTIONAL MEDIA TOOL IN ELEMENTARY AND SECONDARY TEACHING: A LABORATORY FOR IN-SERVICE AND PRE-SERVICE TEACHERS. And that is just what it is. I was very impressed with it and recommend it to all teachers with PETs (it will help you get the REST of the schools teachers interested in computers).

SOME OF MY FAVORITE PROGRAMS

Notice, this is not a list of BEST programs, for such a list could not be compiled. Just what is BEST? Best for whom? Is the fastest the BEST? Or is the longest the BEST? Or the prettiest? How about a long, fast, pretty program? BEST should be used with care, depending upon your situation (yes, I often misuse the word myself too). But I can tell you about my FAVORITE programs, and a bit about them. Some of them may also be your favorites. Then again, you may hate some of them. It is a matter of opinion.

Although I have hundreds of programs, probably half of them I have used no more than once. Plus, there are hundreds more that I do not have. Thus many good programs will be left out. With this in mind (also considering my poor memory) you should be well aware that this is only a partial and personal list.

I would appreciate one favor from you. After you read the list of my favorite programs, please send me a postcard listing your 5 favorite programs. If practical I hope to print a summary of YOUR favorites and possibly list the ones named most often.

Enough ado, on with my list. . .

TOP HONORS

I would like to begin with my all time favorite programs. My most used program is Commodore's Word Processor III which is used daily. It's usefulness is greatly appreciated. It is reviewed in last issue. But on to my favorite games (these are about the only ones I play).

III INVADERS has got to be the fastest moving, real time, sound effects game I have seen on a PET. It appears to rely heavily on machine language programming for its speed. It is said to come from Commodore-Japan. It is one game I show to my guests. My highest score thus far is 3060 (can you beat that score?).

ADVENTURE is a truly amazing game. In it you use two word "sentences" to instruct the computer what to do next. For instance, you might say CLIMB TREE or TAKE AXE. One of the key points of the game is the instructions, or lack of them. Instructions would ruin the game for most, since the biggest challenge is just to figure out what is going on. After several weeks I finally won by collecting all the treasures. This 24K game is available from Creative Computing.

DUNJONQUEST is a series of fantasy role playing games from Automated Simulations. The programs are very sophisticated and require at least 16K, some require a full 32K. DATESTONES OF RYN (16K) is a good one to start with. It is referred to as a MICROQUEST and doesn't include all the options and intricacies of the full blown TEMPLE OF APSHAI (reviewed in the fall 79 issue). My high score in DATESTONES is 3680 in only 19 minutes of play. Let me know if you beat that.

ESCAPE FROM THE DEATH PLANET is a real time, action game, complete with sound effects. You must get through 5 rooms filled with storm troopers and killer robots as well as find and rescue the princess. There are barricades to hide behind, but the robots destroy them piece by piece as they close in on you. You have only your laser, anti-robot missiles, and ingenuity to get you through. Fantasy Games Software wrote this little GEM.

Recommended Games

"Hunt For Treasure" Type Games

There are a wide variety of games available allowing you to fight monsters in search of treasure.

I have already mentioned ADVENTURE and DUNJONQUEST which are prime examples of this type of game. ESCAPE could also fit into this category, since you try to rescue the princess (treasure) and fight off the robots.

HUNT THE WUMPUS is an early entry into this category of games. A more sophisticated version called QUEST came out over a year ago from Peninsula School. It is very enjoyable for children. You must find the treasure as you wander from room to room in the computer world. The problem with it is that once you know how to find the treasure and escape, it isn't much fun anymore. This problem is solved by HUNT.

HUNT is a sophisticated combination of QUEST and ADVENTURE. The computer world, treasures, good guys, bad guys, and the interaction of these are all variables defined by a data tape. Thus after you finally succeed in recovering the treasure, you will not be bored. HUNT WRITER is another program that comes with HUNT. It allows you to create a whole new world with treasures and monsters to challenge you. Hunt is highly recommended and available from PROGRAMMA.

SWORDQUEST is another hunt type game, declared the favorite program of the kids at Peoples Computer Center in Menlo Park. In it you battle giant spiders and demons through a maze of tunnels in search of the magic sword. You must find it and escape the maze with it ALIVE, and it's quite a challenge. Every game uses a new random maze of tunnels and different placement of monsters and exits, so you can always look forward to the next game. It is marketed by FANTASY GAMES SOFTWARE.

Board Games

Many board and strategy games are available as programs for your PET. You can play checkers, mill, backgammon, chess, othello, gomoku, yahtzee, and many more. When you look for a program of this type, make sure to check the options available with the program. Can the PET challenge you, or does it simply play the pieces for two human players, OR can it do either?

All checker programs are strictly for beginners and can easily be beaten by an average player. But children would enjoy them I am sure. Most Backgammon programs seem pretty good. NEECO and HAYDEN have good versions. Chess programs require real sophistication. The best so far seems to be SARGON, and a version from HAYDEN should be available for the PET soon. The next best is MICROCHESS from PERSONAL SOFTWARE. It plays a good game of chess, and should be challenging to the average chess player. Advanced players will delight with SARGON.

Software for the PET

PROGRAMMA Software Program Products

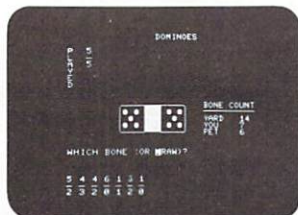

DOMINOES \$ 6.95

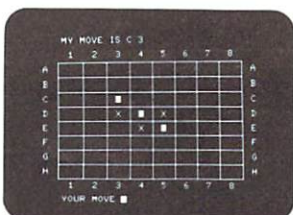

OTHELLO \$ 9.95

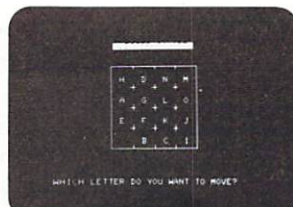

LETTER SQUARES \$ 6.95

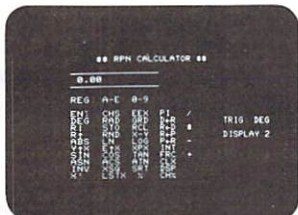

RPN MATHPACK \$19.95

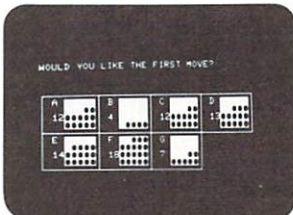

SUPER NIM \$ 6.95

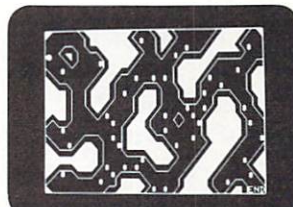

DIR/REF \$ 6.95



SPACE WARS \$ 9.95



GRAND PRIX \$ 6.95

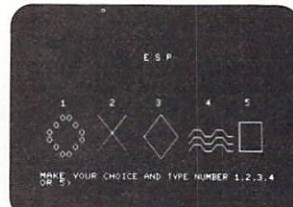

E.S.P. \$ 9.95

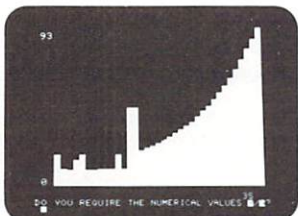

FORECAST \$ 9.95

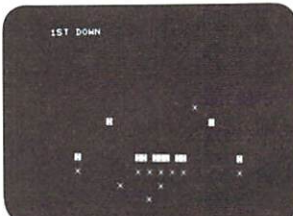

1ST DOWN \$ 6.95



BLOCKADE \$ 9.95

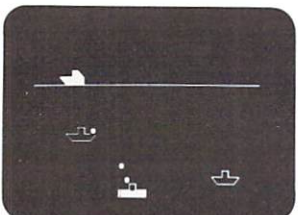

DEPTH CHARGE \$ 9.95

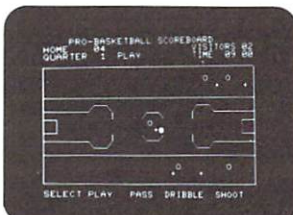

BASKETBALL \$ 9.95

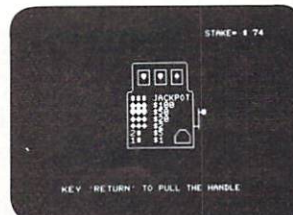

SLOT MACHINE \$ 6.95

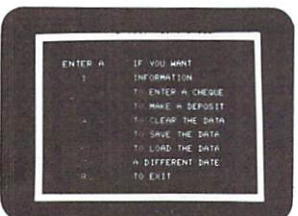

HOME ACCOUNTING \$ 9.95

All orders include 3% postage and handling with a minimum of \$1.00. California residents include 6% Sales Tax.

VISA

MASTERCARD

PET IS A TRADEMARK OF
COMMODORE BUSINESS MACHINES, INC.

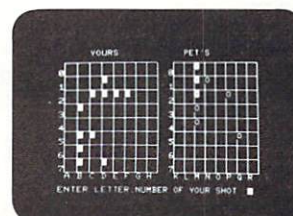

BATTLE SHIP \$ 9.95

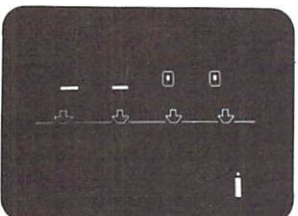

SHOOTING GALLERY \$ 9.95

PROGRAMMA
INTERNATIONAL, Inc.
3400 Wilshire Blvd.
Los Angeles, CA 90010
(213) 384-0579
384-1116
384-1117

Dealer Inquiries Invited



ZAP \$ 6.95

Are you familiar with MASTERMIND? Pete Weiler (of Madison, WI) wrote an excellent version. You can be either the code maker or breaker, or alternate with the PET. But be warned, the PET is very good, you will probably get trounced.

YAHTZEE is a well known dice game. The PET version in the COMPUTE program exchange is the best I have seen. The PET takes care of all the scoring and record keeping for you. The graphic display is superb, typical of PETER ROWE who wrote it.

How about the game MILLES BOURNE, also known as ACCIDENTS or THOUSAND MILES? Programma has a very good version of this classic game for the PET. It is the favorite of several people I know. Watch out for a flat tire or speed limits.

TANKTICS is an excellent game, and unusual in that you get a game board along with the tape and instructions. The PET challenges you. Your moves (for pieces on the board) are entered via the keyboard. Battle results are displayed after you move. The board uses a hexagonal grid for more realism. I thoroughly enjoyed the game, and war gamers will like it for sure. Plesiades Game Company markets it as well as LEGIONAIRE which is a war game with the hex grid displayed on your PET screen. Both are excellent additions to your strategy game library.

BATTLESHIP is a good solitaire game. Programma has a good graphic version played the standard alternating one shot each way. CURSOR had a unique and exciting version where you got up to 7 shots for your turn, depending on how many ships you still had afloat. The PET always beats me at it. CURSOR has had several very good board games. DOTS was very good. You start with a board of dots, and take turns with the PET drawing a line. Draw the fourth side to a box and its yours and you get another turn. Whoever captures the most boxes wins. I managed to beat the PET in this one.

Out Of Room

Well, I am out of room, and have to stop here. More next time. I welcome your comments. Include a self addressed STAMPED envelope if you would like a reply. I can't guarantee a reply to all letters. ©

Editor's Note:

Len welcomes comments on his column and articles. His address is 1929 Northport Drive, Room 6, Madison, WI 53704.

He requests that you include a self addressed stamped envelope if you wish a reply, but cautions that he cannot reply to every letter.

GREAT PET SOFTWARE!



"Precise, humanized, well documented an excellent value" are the applauds now being given to United Software's line of software. These are sophisticated programs designed to meet the most stringent needs of individuals and business professionals. Every package is fully documented and includes easy to understand operator instructions.

KRAM - Keyed Random Access Method - The new, ultra-fast access method for the PET Disk, provides keyed retrieval/storage of data, in either direct or sequential mode, by either full or partial key values. Written by United Software in 6502 machine code, and designed with the PET in mind, it exploits all the benefits of the PET Disk, allowing full optimization of your system. Eliminates the need for "Sort" routines! KRAM provides flexibility never seen on a micro before. KRAM is modeled after a very powerful access method used on large-scale IBM Virtual Storage mainframes. So "KRAM" all you can into your PET - it will love you for it. . . **COST \$79.95**

ACCOUNTS RECEIVABLE/PAYABLE - A complete, yet simple to use accounting system designed with the small businessman in mind. The United Software system generates and tracks purchase orders and invoices all the way through posting "controlled" accounts payable and accounts receivable subsystems.

Keyed Random Access file methods makes data access almost instantaneous. The low-cost solution for the first time computer user with up to 500 active accounts. Requirements - 32K PET, Dual Disk, any 80-column printer. . . **COST \$175**

CASH RECEIPTS & DISBURSEMENTS - Makes it a breeze to track all outgoing payments made by any type of business operation. Checks are tracked by number and categorized by type of expense. Sorting, summary, and audit trails make it easy to post to general ledger. This system also categorizes incoming receipts. Uses KRAM file access method. Requirements - 32K PET, Dual Disk (printer optional). . .

COST \$99.95

DATABASE MANAGEMENT SYSTEM - A comprehensive, interactive system like those run on mainframes! Six modules comprising 42K of programming allow you to; create, edit, delete, display, print, sort, merge, etc., etc. - databases of up to 10,000 records. Printer routines automatically generate reports and labels on demand. 60 pages of concise documentation are included. Requirements - 16-32K PET and 2040 Dual Disk (printer optional). . . **COST \$125**

(Sublicenses available to software houses.)

PROGRAMS FOR ENTERTAINMENT

Space Intruders	
("Best Game of 1979")	\$19.95
Jury/Hostage	12.50
Kentucky Derby/Roulette	9.95
Alien I.Q./Tank	9.95
Tunnelvision/Maze Chase	14.95
Submarine Attack	9.95
Battle of Midway	7.95
Laser Tank Battle	9.95
Swarm	14.95

Super Startrek	14.95
PET Music Box	29.95

UNITED SOFTWARE PROGRAMS FOR BUSINESS

Checkbook	\$15.95
Mortgage	15.95
Finance	12.95
Bonds	12.95
Stock Analyzer	22.95
Stock Options	24.95
6502 Macro Assembler	49.95

Look for the RED-WHITE-BLUE United Software Display at your local computer dealer, or send check or moneyorder, plus \$1.00 shipping to:

UNITED SOFTWARE OF AMERICA
750 Third Ave. **DEALER ORDERS INVITED**
New York, N.Y. 10017 **(212) 682-0347**

Have You Been Bitten By The Computer Bug?

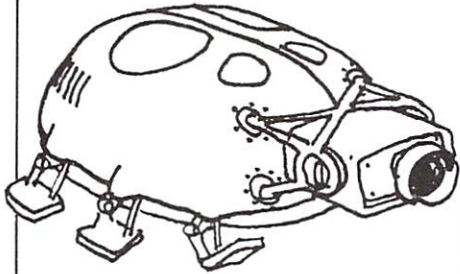

Be A Computer Literate

A first introduction to the computer world for children age 10 to 14. Full color diagrams, drawings, photos and large type make this book easy to read and understand. Written by Marion J. Ball and Sylvia Charp. This informative 62-page book is used in many school systems. Softbound [6H] \$3.95.

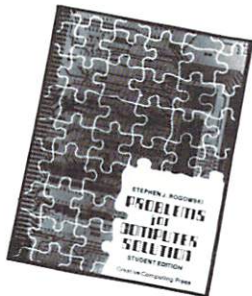

Problems for Computer Solution

Problems for Computer Solution by Stephen J. Rogowski is an excellent source of exercises in research and problem solving for students and self-learners. Problems like the Faulty Speedometer Spotter make learning fun and easy. 104 pages, softbound, [9Z] \$4.95.



Creative Computing Magazine

Creative Computing has long been Number 1 in applications and software for micros, minis, and time-sharing systems for homes, schools and small businesses. Loads of applications every issue: text editing, graphics, communications, artificial intelligence, simulations, data base and file systems, music synthesis, analog control. Complete programs with sample runs. Programming techniques: sort algorithms, file structures, shuffling, etc. Coverage of electronic and video games and other related consumer electronics products, too.

Just getting started? Then turn to our technology tutorials, learning activities, short programs, and problem solving pages. No-nonsense book reviews, too. Even some fiction and foolishness.

Subscriptions: 1 year \$15, 3 years \$40. Foreign, add \$9/year surface postage, \$26/year air.



The Best of Creative Computing

The first two years of **Creative Computing** magazine have been edited into two big blockbuster books. **American Vocational Journal** said of Volume 1, "This book is the 'Whole Earth Catalog' of computers." [6A] Volume 2 continues in the same tradition. "Non-technical in approach, its pages are filled with information, articles, games and activities. Fun layout." —**American Libraries**. [6B] Each volume \$8.95.

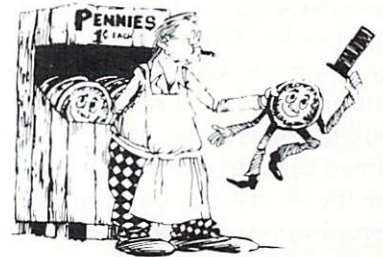

Computer Coin Games

Computer Coin Games by Joe Weisbecker aids newcomers to the field of computers by simplifying the concepts of computer circuitry through games which can be played with a few pennies and full sized playing boards in the book. Enhanced by outrageous cartoons, teachers, students and self-learners of all ages will enjoy this 96 page softbound book. [10R] \$3.95.

Basic Computer Games

Edited by David Ahl, this book contains 101 imaginative and challenging games for one, two, or more players — Basketball, Craps, Gomoko, Blackjack, Even Wins, Super Star Trek, Bombs Away, Horserace. Simulate lunar landings. Play the stock market. Write poetry. Draw pictures.

All programs are complete with listing in Microsoft Basic, sample run and description. Basic conversion table included. 125,000 copies in print. 192 pages softbound. [6C] \$7.50.



More Basic Computer Games

Contains 84 fascinating and entertaining games for solo and group play — evade a man-eating rabbit, crack a safe, tame a wild horse, become a millionaire, race your Ferrari, joust with a knight, trek across the desert on your camel, navigate in deep space.

All games come complete with program listing in Microsoft Basic, sample run and description. 192 pages softbound. [6C2] \$7.50.

How To Order

Send order and payment to **Creative Computing**, P.O. Box 789-M, Morristown, NJ 07960. Add \$1.00 shipping and handling per order (foreign, \$2.50) N.J. residents add 5% sales tax. Visa, MasterCard and American Express orders welcome. For faster service, call in your bank card order toll free to: 800-631-8112. (In NJ, call (201) 540-0445.)

creative computing

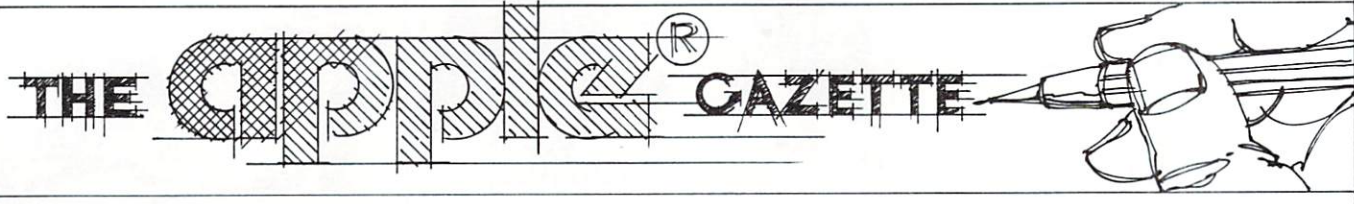

NAMING APPLE CASSETTE FILES

D. P. Kemp
1307 Beltram Ct.
Odenton, MD 21113

To owners of disk based Apples the audio cassette may seem like a relic from the dark ages of personal computing, but for many it is still the only form of mass storage available. Unfortunately the Apple's cassette routines are the most rudimentary of those used in 6502-based systems. While the Pet and AIM support named cassette files and the KIM and SYM use numeric file identifiers, the Apple provides no means of file identification. In addition it requires the user to remember and enter memory addresses when loading binary files, and its method of synchronization requires the user to position the tape properly before entering a load command.

The short program listed here was written to alleviate these problems. It writes a descriptive label at the beginning of each file on a cassette and later reads the labels back to enable the location of any particular file. Because it has nothing to do with the actual data in a file the program can be used with any file type including binary, integer, and Applesoft as well as non-standard files such as text editor data, AppleIIion scores, or relocatable object files. It can be used to name new files as they are created or to label previously existing files on the cassette.

The program occupies memory from \$380 through \$3EF and uses the user function (cntl-Y) vector at \$3F8. To write a file label, simply type cntl-Y and cntl-W followed by up to 40 characters of labeling information. Start the cassette in record mode, then hit return. The label will be written in about two seconds, after which the normal procedure can be used to save the file. To read labels back, type cntl-Y, cntl-R and return, then start the cassette in play mode. If you are searching for a particular file on a long tape, you may fast forward or rewind to get to its approximate location, then play the tape until the label is found. At this point you should hit any key to exit the read routine, stop the recorder, then load the file as you normally would.

There are three points to be remembered when using this routine:

1. The cntl-Y cntl-W command should be the only one on its line. Any commands appearing before it will displace the label; any appearing after it will be ignored. File labels of more than forty characters may be typed but only the first forty are retained on tape.
2. The cntl-Y cntl-R command should be used only when the cursor is at the bottom of the screen, otherwise scrolling will not occur and subsequent file labels will write over each other on the screen.
3. Cntl-Y followed by anything other than cntl-W or cntl-R will cause a breakpoint.

The label's contents are completely up to the user but I tend to follow a specific convention when labeling my own files. The first character indicates the file type - I use I, A, and B as in Apple's DOS or any other character that seems appropriate for special files. A descriptive filename comes next, followed by any pertinent operating information. Since files are not loaded by name there is no need to minimize typing effort, so abbreviations are a no-no. Example labels are:

```
I HIRES KALEIDOSCOPE
(NEEDS PROG AID)
B HIRES SUBS (PROG AID #1) -
6000.63FF
A DIGITAL FILTER RESPONSE
PLOTTER
```

This routine has eliminated the necessity of storing only one or two files on each side of a short cassette; I would guess that each side of a C-90 is now capable of holding about four disk sides worth of programs and data. The label routine is easy to operate and small enough to remain in memory permanently, and it now occupies the first file of each Apple cassette I own.

Listing 1: Apple cassette file label routine

```
0360- C8      INY
0361- B9 00 02 LDA $0200,Y ;fetch next character
0364- C9 92   CMP #92 ;cntl-R?
0366- F0 3F   BEQ $03C7 ;yes.
0368- C9 97   CMP #97 ;cntl-W?
036A- D0 3C   BNE $03C8 ;no - error
036C- A2 28   LDX #28 ;yes.
036E- C8      INY
036F- B9 00 02 LDA $0200,Y ;find end of label
0392- C9 8D   CMP #8D
0394- F0 1C   BEQ $03B2 ;fill rest with blanks
0396- CA      DEX
0397- D0 F5   BNE $038E
0399- A2 04   LDX #04
039B- BD BC 03 LDA $03BC,X ;set up to write label
```

```

039E- 95 3B STA $3B,X
03A0- CA DEX
03A1- D0 F8 BNE $039B
03A3- A0 C0 LDY #$C0
03A5- 20 E2 FC JSR $FCE2 ;write it
03A8- D0 F9 BNE $03A3
03AA- A9 08 LDA #$08
03AC- 20 CF FE JSR $FECF
03AF- 4C 69 FF JMP $FF69 ;return to monitor
03B2- A9 A0 LDA #$A0
03B4- 99 00 02 STA $0200,Y ;blank fill end of label
03B7- C8 INY
03B8- CA DEX
03B9- D0 F9 BNE $03B4
03BB- F0 DC BEQ $0399
03BD- 02 02 ;write pointers
03BF- 29 02
03C1- 20 02 FF JSR $FF02 ;read label
03C4- 20 8E FD JSR $FD8E
03C7- AD 00 C0 LDA $C000 ;key pressed?
03CA- 10 06 BPL $03D2 ;no.
03CC- AD 10 C0 LDA $C010 ;yes - reset status bit
03CF- 4C 69 FF JMP $FF69 ; and return to monitor
03D2- A2 80 LDX #$80
03D4- A0 70 LDY #$70
03D6- 20 FA FC JSR $FCFA ;search for label
03D9- 90 EC BCC $03C7
03DB- CA DEX
03DC- D0 F6 BNE $03D4
03DE- A2 04 LDX #$04
03E0- BD EB 03 LDA $03EB,X ;set up for read
03E3- 95 3B STA $3B,X
03E5- CA DEX
03E6- D0 F8 BNE $03E0
03E8- A9 04 LDA #$04
03EA- D0 D5 BNE $03C1
03EC- D0 07 ;read pointers
03EE- F7 07
:
:
03F8- 4C 80 03 JMP $0380 ;cntl-Y vector

```

On Interfacing An Apple II To A Heathkit H-14 (‘COMPUTE’, JAN/FEB/80, ISSUE2)

Mike Wiplich

I am also using an Electronic Systems serial I/O card for the Apple II. The card has been set up for 4800 baud using hardware handshake (RTS from H-14). This was done by connecting RTS from the H-14 (pin 4 on ‘D’ connector) to the DTR input of the serial card and using the software listed below.

A note is in order here. The software is designed to be compatible with DOS. It is installed in a separate ram between \$C800 and \$C85F. This ram must be supplied by the user as it is not normally part of the Apple II. The alternate solution is to relocate the code. The routine modifies the DOS output register so that all output characters are not only examined by DOS, but also by the printer driver. Upon receipt of a ‘CTRL P’ the printer driver will send all subsequent output to the printer until the receipt of a ‘CTRL O’ which will now bypass the printer. Video output is active at all times. The routine is also capable of printing upper and lower case using the ‘Screen Machine’ software from SOFTAPE.

To initialize the routine from machine-C800G, or from BASIC call -14336. After initializing, ‘CTRL P’ and ‘CTRL O’ work as described above.

As written the routine is set up for the serial card in slot 1 with jumper J1 connected to pin 41. The receive capability of the card is not used.

Let me add that I am quite happy with the H-14.

C800LL

```

C800- AD 53 AA LDA $AA53
C803- 8D 21 C8 STA $C821
C806- AD 54 AA LDA $AA54
C809- 8D 22 C8 STA $C822
C80C- A9 23 LDA ##23
C80E- 8D 53 AA STA $AA53
C811- A9 C8 LDA ##C8
C813- 8D 54 AA STA $AA54
C816- A9 00 LDA ##00
C818- 8D 07 03 STA $0307
C81E- A9 00 LDA ##00
C81D- 8D 5F C8 STA $C85F
C820- 4C F0 FD JMP $FDF0
C823- C9 8F CMP ##8F
C825- F0 F4 BEQ $C81B
C827- C9 90 CMP ##90
C829- D0 04 BNE $C82F
C82B- A9 80 LDA ##80
C82D- D0 EE BNE $C81D
C82F- 48 PHA
C830- AD 5F C8 LDA $C85F
C833- D0 03 BNE $C838
C835- 68 PLA
C836- D0 E8 BNE $C820
C838- 68 PLA
C839- C9 C1 CMP ##C1
C83B- 30 03 BMI $C840
C83D- 4D 07 03 EOR $0307
C840- 48 PHA
C841- AD 91 C0 LDA $C091
C844- 29 03 AND ##03
C846- C9 03 CMP ##03
C848- D0 F7 BNE $C841
C84A- 68 PLA
C84B- 8D 92 C0 STA $C092
C84E- C9 C1 CMP ##C1
C850- 30 CE BMI $C820
C852- 4D 07 03 EOR $0307
C855- D0 C9 BNE $C820
C857- 00 BRK
*3

```

©

AT LAST...80 COLUMNS AND UPPER/LOWER CASE LETTERS FOR APPLE II

Michael S. Tomczyk
418 Arguello Blvd.
San Francisco, CA 94118

Where were you when the earthquake hit? I was in Sunnyvale, California when the 5.5 point Livermore earthquake rattled the headquarters of M&R Enterprises, luckily with no damage.

M&R President Marty Spergel, designer John Wilbur and I just grinned as we bounced back and forth, all of us thinking how ironic the quake was... since M&R has been causing some minor tremors of its own with a new intelligent board terminal for the APPLE II. The new board is called "Sup'R'-Terminaltm" -- and with 80 columns and upper/lower case letters, it's definitely a super development in the personal/business computer field.

Apple owners and dealers have been speculating for months over what the new board would -- and would not -- do, so I went down for a sneak preview and here, in a nutshell, are some answers to help scotch or confirm all those rumors...

1. The new Sup'R' Terminaltm converts the APPLE II screen to an 80 column x 24 line, upper/lower case display (5x8 dot matrix, ASCII character set)...making the APPLE II the first personal computer with this capability.
2. Installation is easy -- just plug the board into slot number 3, hook it up to a monitor and it's ready to go.
3. The board can be used with an inexpensive black & white 8MHz CRT monitor, but is not recommended for use with a normal television, which doesn't have the needed resolution or bandwidth to legibly display the smaller characters.
4. Display is in black and white only -- sorry, no color.
5. The board is fully compatible with all APPLE software (including APPLE INTEGER BASIC, APPLESOFT BASIC and PASCAL), and several other software systems (i.e. EASYWRITERtm) are being adapted to it.
6. 2K of human-engineered, board-based editing software is included.
7. Peripherals such as disc drives and printers are fully compatible with the board, which is designed to interface with future hardware developments, such as updated disc drives, without modification.
8. When used with an APPLE II communications interface board and a program supplied in M&R's documentation manual, Sup'R'-Terminal can act as a self-contained terminal for time-sharing or other applications.
9. Effective baud rate is greater than 10,000, enabling fast clearing and scrolling.
10. Suggested retail price is \$395.

The implications of the new board are enormous. Until now, APPLE users could only view 40 columns of upper case letters on their monitors, and couldn't use PASCAL (which is set up for 80 columns) to best advantage. Some owners even considered adding thousand dollar terminals to give them an 80 column, upper/lower case capability. With Sup'R' Terminal, the problem is solved.

Now wordprocessors can see the full width of their text just as it comes out on the page printer. Businessmen and accountants will be able to bring up more columns for easier tabulation and number-crunching. Even game buffs will benefit, especially if they use timesharing.

Marty Spergel sees timesharing as the most exciting application -- and it's no coincidence that M&R already manufactures a phone modem (the Pennywhistletm) for this purpose.

He noted that any computer owner can now access a sophisticated time-sharing system for as little as \$2.75 an hour during non-primetime, but these services use a minimum 80-column format and that makes it hard to access on a 40-column monitor. He went on to explain that long programs which take up the whole screen often get scrolled off when 40-column users access it, and may be lost when the timeshare facility stops sending data. With full 80-column interface this doesn't happen, and he added that he thinks a lot more businesses will start using APPLE's for timesharing because of the new board.



ULTIMATE JOYSTICK FOR THE APPLE II

\$49.95

The Apple Joystick is a quality crafted dynamic interactive I/O device engineered specifically for the apple computer. The stick comes completely wired for paddles 0 & 1 and switches 0, 1 & 2. Among the excellent features of the stick are auto-centering, which positions the stick in the center of its range whenever the handle is released, and positive action switches with tactile feel and audible feedback.

The stick assembly itself is a precision molded unit originally designed for the ultimate in smooth linear proportional control required for international radio-control model competition.

The heart of the stick centers around two cermet resistive elements with bifurcated wiper contacts, which provide the smooth continuous change in resistance not found in wire-wound elements.

As an added bonus, all game I/O connections are brought out and terminated in the cabinet. This feature facilitates modification and/or implementation of all game I/O functions, such as, (example: annunciators, sound, paddles 2 and 3). Using Gesu's double I/O extender cable and two joysticks (one modified for paddles 2 and 3) two player joystick games can be implemented.

Normally no adjustment is required upon installation of the stick in your Apple computer. However, if it should become necessary to adjust the centering, mechanical adjustment tabs are provided inside the stick cabinet.

Refer to the Apple II reference manual for directions on how to install the stick in your computer.

GAME I/O EXTENDER CABLES

SINGLE \$10.00
DOUBLE \$16.00

The single model consists of one foot of cable, one 16-pin male and one 16-pin female connector. The extender plugs into the game I/O and the female end if secured to the outside of the cabinet with the double-backed mounting tape provided. Installed in this fashion the extender eliminates the necessity of opening the apple computer to install or remove the stick or any other game device.

The double model is exactly the same as the single model with the addition of a second 16-pin female connector. This extender has the same advantages as the single extender plus allowing two sticks or game I/O devices to be installed simultaneously. Note: When two games I/O devices are installed simultaneously make sure no conflicts exist between paddle assignments. Only one device should be assigned to each paddle.

ComputerWorld

6791 WESTMINSTER AVENUE
WESTMINSTER, CA 92683
(714) 891-2587 TELEX 182274

SUP'R TERMINAL NEEDS A MONITOR

The board's biggest drawback is that it has to be used with a monitor -- not a television set. Standard television screens have too low resolution and bandwidth to properly display the smaller characters which result when you go to 80 columns. This means some APPLE owners who are now using a home console will have to go out and buy a black and white monitor. With the \$395 price tag for the board plus \$150-200 for an inexpensive monitor, this could boost the price to as much as \$600.

Recognizing that a lot of APPLE II owners will want to get a "cheap" monitor but still want good image quality, M&R built in two features which enable the user to get superior resolution from an inexpensive monitor.

System designer John Wilbur, who spent several hours demonstrating the board for me, explained that two simple screwdriver adjustments make this possible. He pointed out that under normal circumstances, a low-priced monitor displays horizontal lines much brighter than vertical lines -- for example, the horizontal line in the letter "L" shows up several times brighter than the vertical part. M&R's unique "Video Balance Circuittm" compensates by reducing the brightness of the horizontal lines in the characters. When used in conjunction with a second adjustment, which controls overall light intensity, excellent resolution is obtained.

Using both the Sup'R Terminal and APPLE's color graphics mode requires the use of two screens -- a black and white monitor for the terminal, and a color monitor or television set for color mode. Both can be operated from the same computer, but not simultaneously. Incidentally, APPLE graphics work with the Sup'R Terminal but only in black and white.

If the prospect of having to get a black and white monitor to use the terminal board, not being able to use your television, and maybe using two separate screens for color and black and white sounds cumbersome or expensive, you're right. But then, the major use for the terminal is business and timesharing, and in fairness, the state-of-the-art technology limitations aren't M&R's fault.

AVAILABILITY

At press time, M&R's game plan was to send 300 evaluation boards to dealers across the country so they can analyze it and show it to their customers. The boards were scheduled to go out in early February, with M&R geared up for volume production by March. Marty Spergel emphasized that deliveries on orders will be prompt.

A final question that occurred to me was whether M&R will come up with a Sup'R Terminal for the Commodore or Atari -- but Marty just shook his head, smiled, and said, "No comment." I'm not sure what he meant by that, but you can be sure

I'll be writing about it if something develops.

For more information you can write: M&R Enterprises, P.O. Box 61011, Sunnyvale, CA 94088. Next issue: Using the Sup'R Terminal and user defined character sets... ©

Apple Software

Eric Rehnke

The last time I visited MICROPRODUCTS in Redondo Beach, proprietor Paul LaMar showed me two very interesting software packages which he sells.

The first is called the Text File Manager and is actually a two-pass disassembler which creates an assembler source from pure object code. Think about it. Remember that undocumented program you purchased and needed to modify? Or how 'bout a way to probe the mysteries of the APPLE DOS?

Text files that are created with the Text File Manager can then be assembled with the MICROPRODUCTS Assembler. Other features are included to make this package look even more useful. (I wish I could get this for my KIM).

The other software package Paul demonstrated is called APPLEBUG. This is a debug tool and enhanced machine language monitor. You can single-step, trace and/or run through a program until one of four breakpoints or an 'RTS' is detected. Up to 8 memory locations may be traced during execution. Lots of other features that you can read about if you send for a catalog:

MICROPRODUCTS
2107 Artesia Blvd.
Redondo Beach, Ca 90278
(213) 374-1673 ©

Apple Authors

We know you're out there. COMPUTE wants the Apple Gazette to enjoy a long and happy life. We need your input! Send articles, reviews, news items, and club notes to:

Apple Coordinator,
COMPUTE,
Post Office Box 5119,
Greensboro, NC 27403

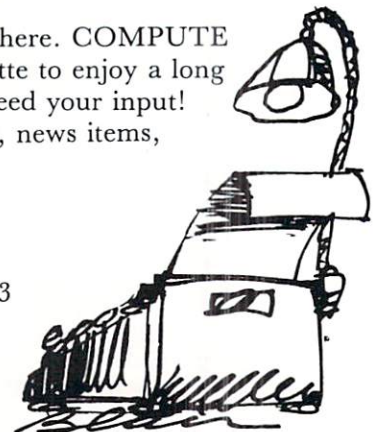

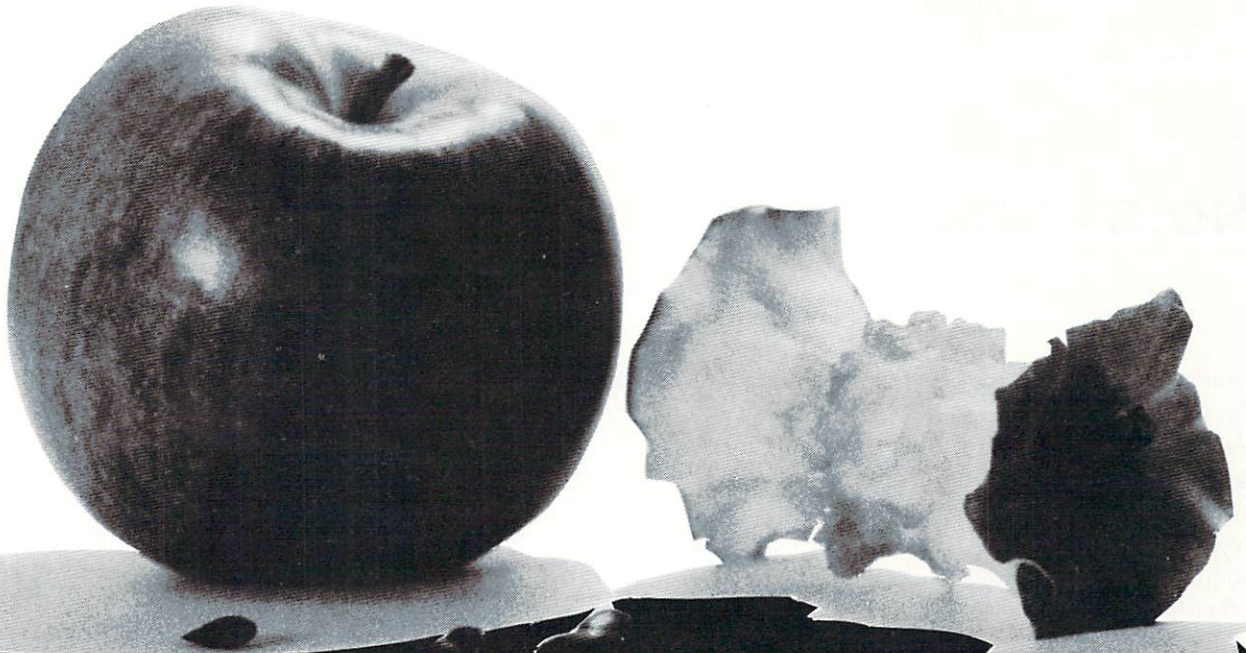

Introducing AppleSeed, our newest publication to whet your Apple* appetite!

We invite you to subscribe to AppleSeed - the magazine that is to the Apple II* what SoftSide is to the TRS-80**. It offers the newest in software programming hints and ideas tailored especially for your computer. AppleSeed features challenging programs for both the do-it-yourselfer and the individual interested in pre-packaged programs and games ... your own preview of the best available on the market today. A typical slice of AppleSeed consists of one major (new 16K) commercial level program (completely listed for your keying pleasure), accompanied by two or three applications for practical use or fun, supplemented by informative articles to polish your Apple*. Get right to the core of your Apple* needs and order AppleSeed today! 12 issues, 1 year, \$15.00. AppleSeed is the newest member of ...

SoftSide™
PUBLICATIONS

6 South Street, Millford, NH 03055
(603) 873-5144

*A registered trademark of Apple Computers. **A registered trademark of Radio Shack and Tandy Corp.

THE ATARI® GAZETTE



Notes on Atari

Robert Lock

One substantial impact of the Consumer Electronics Show in Las Vegas was watching a group of people interacting with the new Atari machines. I realized only later why it was impressive: The software was totally integrated with the full capabilities of the system. Our machine experience in the past has been one of a core machine with various and sundry peripherals available, all from different vendors, none capturing a sufficient share of the market to warrant the total dedication of a line of software to their support. Atari has changed that, introducing a line of hardware already fully supported with sound, color, joysticks, and so on. I think John Victor summed it up well in an earlier article in COMPUTE when he said that one of the most impressive aspects of Atari Basic was the fact that control of color, sound and peripherals were built into the language from the start. You'll realize more of the impact of that when you get the chance to see a piece of the software.

If you're interested in being part of COMPUTE's Atari Software on Tape Exchange, drop us a letter: COMPUTE., ATARI TAPE, P.O. BOX 5119, GREENSBORO, NC 27403

©

STAR RAIDERS DEFEND THE GALAXY

Joretta Klepfer, COMPUTE. Staff

Welcome to the ATARIAN STARSHIP FLEET, STAR RAIDERS, charged with the responsibility of protecting the Atarian Federation from the ZYLON Empire. (ZYLONS, naturally, are the ENEMY trying to eliminate humanity as we know it.) This ship is your training ground to become a member of that elite group of officers known as STAR COMMANDER. The possibilities of advancement to that

command depend on your skill in maneuvering the starship through hyperspace to seek and destroy ZYLON fighters, cruisers, and basestar ships before they can surround and destroy your STARBASES. (Friendly starbases are where you replenish your life support systems and repair starship damage.) Should you fail to make ROOKIE, you may be relegated to the position of Galactic Cook. (Oh well, we all have to start someplace.)

STAR RAIDER is incredibly exciting to play and just about as much fun to watch! Looking through the window of your ship, you guide it through space, using a joystick, fire PHOTONS with the fire button (on the joystick), and use the computer keyboard to change the screen display and various parameters of the game. A Galactic Chart will display, at your command, a view of the entire galaxy divided into sectors. This chart indicates which sectors contain ZYLON starships, which ones contain your starbases, and where your ship is presently located. Movement from one sector to another is made by using hyperwarp speed. Movement within sectors is slower warspeed and determined by typing one of the digits 0-9, with 0 representing no speed and 9 being very fast. Your Sub-Space Radio will keep you posted on happenings in the rest of the galaxy. You are assisted by an attack computer which displays crosshairs at the center of the screen and a special display in the lower right corner for sighting your targets. A CONTROL PANEL located in the bottom four lines of the screen is a valuable aid in maneuvering the ship and finding targets. Keep an eye on your fuel and head for the nearest friendly starbase when you get low; the mission is aborted when you run out of energy.

The dynamic graphic screen displays are fascinating to watch. I particularly enjoyed the three-dimensional effect. The use of color and sound is an integral part of the program. So much so, in fact, that you will quickly become acclimated to what the different sounds and colors mean and know immediately what is happening in the game before you see any messages on the screen. The RED ALERT signal flashes solid red on the screen and sounds a warning signal appropriate to the occasion letting you know you are entering a sector with enemy warships. Color is also used to distinguish spaceships from stars and meteors. (Did I mention that you have to avoid meteors, too?). Warning sounds alert you that a starbase is surrounded (you have one minute to save

it) or has been destroyed (you didn't make it!). Traveling through hyperspace produces yet another sound.

The STAR RAIDER program totally integrates the capabilities of the Atari computer. Graphics, sound, color, keyboard and joystick control, all contribute to the total effect of the game and make it exciting to play.

This game has something for everyone: fast action, intrigue, levels of difficulty, sound, color; the list goes on. A few notes of warning: (1) Do take time to read the manual before playing the game; you can have much more fun playing if you know how to cope with all the features of the game.

(2) THIS GAME IS ADDICTIVE!! Two hours can slip by while you are absorbed in the game without any awareness of the passing of time (except for stardates). (3) If you relinquish your place at the helm to someone else, be prepared to wait a long time before reclaiming it.

It's my turn to defend the galaxy now. Good luck with your mission (should you decide to accept it). Betcha can't play just once!

©

ATARI ANNOUNCES EXCLUSIVE SPACE INVADERS™ LICENSE

Sunnyvale, California - ATARI, INC., (Atari® Consumer Division, 1265 Borregas Avenue, P.O. Box 427, Sunnyvale, CA 94086), a division of Warner Communications Inc. has announced a license agreement with Taito Corporation of Japan under which Atari is granted the exclusive right to use the name **SPACE INVADERS™** in connection with the manufacture or sale of non-coin-operated video games, personal computers, and handheld electronic toys and games. **SPACE INVADERS** is currently the world's most popular video arcade game.

Atari recently introduced a **SPACE INVADERS** cartridge for its programmable Video Computer System™ and a handheld version of **SPACE INVADERS** at the Toy Fair in New York on February 10, 1980.

Michael J. Moone, President of Atari's Consumer Division stated, "This exclusive agreement offers a tremendously exciting opportunity for Atari to bring this record-breaking arcade game to the home market. Atari has aggressive marketing plans for these two products and, as the sole licensee of the **SPACE INVADERS** name in these product categories, will be working with Taito to protect our exclusivity and pursue certain unauthorized users now selling products bearing the **SPACE INVADERS** name." ©

STAR RAIDERS: The Wizard Behind The Game

Michael S. Tomczyk
418 Arguello Blvd. Apt. 2
San Francisco, CA 94118

A lot of people have been asking who designed Atari's fantastic STAR RAIDERS™ game. It turns out that the wizard behind the game is a 26-year old chip designer named Doug Neubauer.

Doug came up with the idea for the game about two years ago. He wanted to do a sophisticated STAR TREK-type game, and bring in some elements from STAR WARS, CLOSE ENCOUNTERS and all the other space movies.

After getting the go-ahead from Atari, he spent 8-10 months programming it. By comparison, a 2K Atari game normally takes 5-6 months to program.

"The original version didn't have all the levels of difficulty such as damage control or anything like that," he recalls. "Those things just sort of evolved."

At one point the game consumed up to 9K memory and Doug had to scrunch it back down to its current 8K. He said Atari was very supportive through the whole process.

"They're pretty easygoing," he said. "The programmers are more or less on their own as far as doing their own ideas and coming up with a game -- there's not too much structure."

Today, STAR RAIDERS promises to be one of the most popular and sophisticated games on the market. Doug doesn't have a financial piece of the game, however, and says he never really thought about it in that way. "I almost would have done it for nothing, to tell you the truth," he admitted.

Surprisingly, Doug doesn't even have a copy of the game. He left Atari in August 1975 because he wanted to move back to his native Oregon, and now works as a chip designer for Hewlett-Packard's calculator division in Corvallis, Ore. At the time he left Atari, they didn't have the game finished -- just the prototype. He doesn't know if he'd play it much if he had one. "I'm pretty burned out on it," he explains, "although I guess I'd play it now that I've been away from it for awhile."

Is the STAR RAIDERS designer a good player? He just laughed and said, "You won't master it in a week. I played it since the beginning and finally made the top rank -- Star Commander 1 -- after six months." ©

Review

Atari Basketball Cartridge

Len Lindsay

This cartridge plugs into your ATARI 400 or 800 in the left socket (in place of the BASIC cartridge). The game utilizes ATARI's high resolution color graphics as well as sound effects. The basketball players actually have arms and legs that move around resulting in excellent animation. The cartridge has 5 different games - allowing from 1 to 4 players, and varying computer controlled players. A joystick is required for each person playing.

I like to compare the game to FOOSBALL, a game found in game rooms and bars. It seems awkward at first, but the more you play, the better you get, and the more fun you have. There are many tricks to learn on the way to becoming a professional player. For instance, the red button is your shoot the ball button, but hitting it doesn't shoot the ball. It causes your player to swing the ball over his head and back down, then repeat the process. The ball is shot when you release the button. The type of shot is determined by where the ball is when released, allowing short or long shots.

Competition is either 1 on 1 or 2 on 2. With two players per team, each player also has the option to pass the ball, shoot it or dribble around. The game is by no means simplistic, running to your basket and shooting. Rather it is exciting, due to the fact that you can play good defense too.

With one player it is you against the ATARI. With two playing, you have a choice. You may both play as a team against two computer controlled players. Or you may play against each other. With three players, one is teamed up with a computer player. Four players, obviously play two against two.

After playing a few games, it seems that the better you play, the better the computer plays. This should make the game more interesting, even after you get good at it, although playing against another person is just as much fun.

You can steal the ball from another player, intercept a pass, or jump to block a shot. It is also interesting to see who recovers the rebound. To block a pass, you hit the red button, and your player jumps up. Stealing the ball is a bit tricky and may be referred to as an art (fine art of stealing the ball). Intercepting a pass is simple, if you are in the path of the ball that has been passed. A loose ball is recovered by running and grabbing it.

All in all, this is a good game. I have talked to people who are rapidly becoming ATARI basketball addicts. They can't wait to play another game. It is very similar to the game seen in the arcades, but with many added features. The price has been reduced from \$50 to \$40.

More reviews next time.

©

Atari Program Saving

Len Lindsay

If you are having problems reading tapes you just made of your program, be comforted that you are not the only one. Here is a bit of information that should help clear up your problem.

You can clear the screen with a SHIFT CLEAR. This takes two keys, and you probably already know that hitting RESET does the same thing. AHA! Did you know that RESET also has the side effect of messing up some pointers that are important when saving your program to tape? The cure is simple, don't use the RESET key. But that really isn't a solution.

Here is the solution. Just before you do the CSAVE enter this line:

```
LP. [RETURN]
```

The ATARI will come back with an error message (unless you have their printer hooked up) but you may ignore it. Now do your CSAVE in the normal manner.

You also should be aware of several ways to save a program. Here they are:

```
CSAVE [RETURN]
```

The program is read back in with the command CLOAD. This is the common method. It is how to load commercially purchased tapes.

```
SAVE"C: [RETURN]
```

The program must be read back with the command LOAD"C:.

```
SAVE"S: [RETURN]
```

This saves your program to your screen. This is not a useful way to save a program, but is interesting to watch.

```
LIST"C [RETURN]
```

This will save your program to tape in untokenized form. (The normal CSAVE saves the program as tokens, taking up less room.) The program must be read back with the command ENTER"C.

Programs may also be saved to disk, and I hope to talk about that next time. Try out each of the above methods of saving your programs. Let me know which method seems most reliable for you.

©

IRIDIS™

FOUR EXCELLENT PROGRAMS FOR YOUR ATARI™ 800

CLOCK

No—this isn't another digital clock! It's an old-fashioned wall clock, with chimes to charm you. And it keeps on ticking . . .

ZAP

Grab a joystick and try to zap the targets. Has an "attract" mode when you don't want to play. You'll also learn how to use the **ATARI** **START** button in your Basic programs.

LOGO

A flashy demo that shows off the **ATARI** color registers.

POLYGONS

Your **ATARI** constructs beautiful geometric patterns.

IRIDIS #1 is available now. You get a C-30 cassette or a high-quality diskette with four excellent programs for your **ATARI** 800. The programs are ready to "Load" and "Run". You also receive the 24 page **IRIDIS** GUIDE which provides clear instructions for the programs, as well as important information about how to get more out of your **ATARI**.

Our programs are written to be studied as well as used. The **GUIDE** will have complete source listings of selected **IRIDIS** programs. Not just listings, but an explanation of what's going on. If you are new to programming, **IRIDIS** is one of the easiest ways you can learn advanced techniques. If you're an old hand, you'll still find **IRIDIS** to be a rich source of ideas and **ATARI** techniques.

ATARI is a trademark of **ATARI, Inc.**

Please send me **IRIDIS** #1 for my **ATARI** 800 immediately.

\$9.95 Cassette \$12.95 Disk

Name _____

Address _____

City _____

State/Zip _____

VISA Card Number _____

MasterCharge Expires _____

Signature _____

Published By:

**The Code
Works™**

Box 550
Goleta, CA 93017
805-967-0905
Dealer Inquiries Invited.

Review of ATARI 810 Disk System

Ron Jeffries and Glen Fisher
The Code Works™

The Atari 810 disk system is very easy to install: unpack it, read a couple of pages of the Operators Manual, plug in two cords, turn it on, insert a diskette and you are up and running. (If and only if you have 16K or more memory. Otherwise, the screen does strange things, including producing some fascinating patterns.)

The Disk Drive Operators Manual shipped with the early units is actually only an 11 page looseleaf booklet. The information in the booklet is clear, with an excellent diagram that should make it possible for almost anyone to set up the disk system correctly. Maybe that seems minor, but things haven't always been this way folks. On the other hand, 11 pages is not enough to say all the things that need to be said to a person that just bought their first disk. We didn't have any real problems, but then again the Atari isn't the first disk we've used. As of late January, the Disk Operating System (DOS) Reference Manual isn't yet available. Atari has done a great job getting a "total system" out, including disk and printer. But documentation seems to be much harder to get out the door than either hardware or software.

The disk drives are nicely packaged in injection-molded plastic cases. You can stack two disk drives, and even put the 820 printer on top and still have a stable arrangement that takes only a 10 inch by 14 inch area. There are small indentations on the top of each disk cabinet that provide a solid platform for the one stacked on top of it. Everyone that has seen our unit has commented on how attractive the packaging is, and how it looks like a consumer product. One fact of life with the Atari is that there are lots of cords, to connect everything together, as well as supply power. Since Atari uses separate UL-approved power adapters for everything except the cassette recorder and the 820 printer, you soon find that there are a lot of power adapters to put somewhere. On the other hand, having the transformers separate from the disks and the computer probably contributes to their compact look.

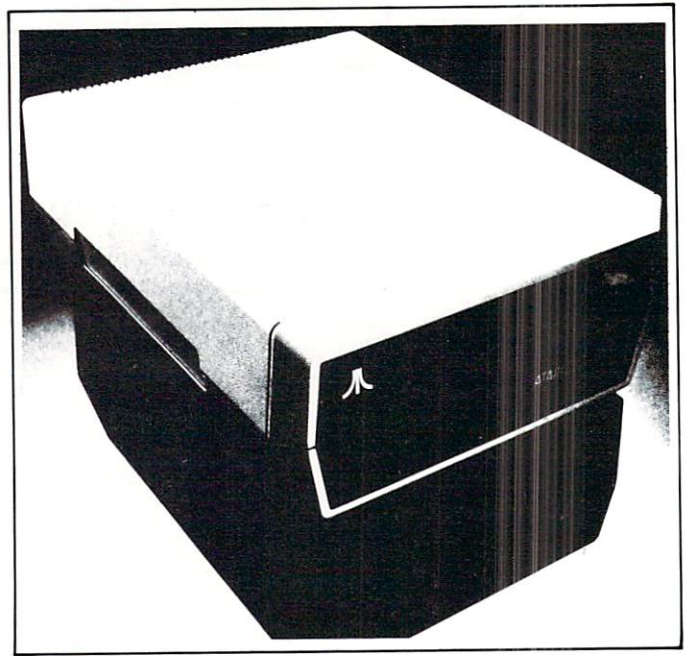

To load the DOS, the 810 disk is turned on and the Master Diskette (containing the DOS) is inserted. The Atari computer itself is then turned on, which automatically drags the DOS into memory. After about ten seconds the message "READY" appears on the screen. Now, when you type the command "DOS", a menu will appear:

```
DISK OPERATING SYSTEM 9/24/79
COPYRIGHT 1979 ATARI
```

- A. DISK DIRECTORY
- B. RUN CARTRIDGE
- C. COPY FILE
- D. DELETE FILE
- E. RENAME FILE
- F. LOCK FILE
- G. UNLOCK FILE
- H. WRITE DOS FILE
- I. FORMAT DISK
- J. DUPLICATE DISK
- K. BINARY SAVE
- L. BINARY LOAD
- M. RUN AT ADDRESS
- N. DEFINE DEVICE
- O. DUPLICATE FILE

SELECT ITEM

"Run Cartridge" means "leave DOS". At least for now, the DOS can't be used unless you are using the Basic cartridge. Later on there may be other languages. One we hope to see soon is an assembler and editor for working with 6502 machine language.

A good feature of the Atari DOS is the ability to "lock" a file, so that it can't be deleted, re-

MORE COLOR. MORE SOUND. MORE PERSONAL/BUSINESS POWER.

ATARI 820 Printer. High resolution, dot-matrix printer keeps a permanent record of your programs and their results.

Joystick, paddle and driving controllers. Let you direct the action in some of the most challenging computer games you have ever played.

ATARI 810 Disk Drive. Dramatically increases your memory storage capabilities.

Diskettes (not shown). Standard 5 1/4 inch size. Store a full 88K bytes per diskette.

ATARI 800 Personal Computer. Easy to operate. Easier to own. This is where the age of the personal computer begins.

Expandable memory. An 8K or 16K Memory Module™ gives you the ability to instantly expand your computer's memory up to 48K.

ATARI 410 Program Recorder. Lets you write and store your own programs on standard audio cassette tapes.

Atari pre-recorded cassette tape programs. In a wide range of subjects, from computerized study to small business management.

Atari plug-in cartridge programs. A complete library of education, practical applications and dynamic entertainment.

Computer control keyboard. Full 57 key. Operates like an electronic typewriter to give you full upper and lower case alphanumeric and graphic display control.

ATARI 800.
Think of the possibilities.

Compare the built-in features of leading microcomputers with the Atari personal computers. And go ahead, compare apples and oranges. Their most expensive against our least expensive: the ATARI® 400™.

Start with graphics capabilities. The ATARI 400 offers 128 color variations. 16 colors in 8 luminance levels. Plus 29 keystroke graphics symbols and 8 graphics modes. All controlled from a full 57 key ASCII keyboard. With upper and lower case. And the system is FCC approved with a built-in RF modulator. That's just for openers.

Now, compare sound capabilities. Four separate sound channels and a built-in speaker. With the optional audio/digital recorder, you can add Atari's unique Talk & Teach™ Educational System cassettes.

Here's the clincher: Solid state (ROM) software. For home management, business and entertainment. Or just plug in an Atari 10K BASIC or Assembler language cartridge and the full power of the computer is in your hands.

Memory? 8K expandable to 16K. And that's just for the ATARI 400 at a suggested retail of only \$549.99.

The ATARI® 800™ gives you all that and much more.

User-installable memory to 48K. A full-stroke keyboard.

With a high-speed serial I/O port that allows you to add a whole family of smart peripherals. Including up to four individually accessible disk drives. And a high speed dot-matrix impact printer. And, the Atari Program Recorder is included with the 800 system. Suggested retail price for the ATARI 800 (including recorder) is \$999.99.

Make your own comparison wherever personal computers are sold.

Or, send for a free chart that compares the built-in features of the ATARI 400 and 800 to other leading personal computers.

Atari promises to be the most popular Personal Computer System of the 1980's! Feel free to contact us for Atari literature.



NEECO

679 Highland Ave.
Needham, MA
02194

Customer Sales:

NEECO
679 Highland Ave., Needham, MA 02194
(617) 449-1760

Circle 77 on inquiry card.

Dealer Sales:

Microamerica Distributing
21 Putnum St., Needham, MA 02194
(617) 449-4310

Circle 72 on inquiry card.

named or written into. This can be very handy if you have an important file that you want to protect. (As an aside, we've heard that the same people that wrote the Apple DOS worked on the Atari version. Guess what? Apple is the only other micro system we know of that has a "lock" capability.)

"Write DOS" is how you make new copies of the DOS. Unlike some systems, the Atari DOS is a normal file, instead of being hidden away in some secret location on the disk. Each diskette can hold 709 sectors of 128 bytes each. The DOS takes 64 of these sectors, leaving 645 sectors or about 86K bytes for your files.

Alas, all is not sweetness and light.

First, the DOS uses about 9K of your memory. So, on a 16K Atari, when you first turn on the system, you'll have about 4300 bytes left of the 16K. (Here is the math: a "pristine" 16K Atari has 13326 bytes of memory available for your program. The rest is used by Basic, the operating system, and as screen memory. The Atari DOS comes configured for four drives, and when it is loaded into the computer you have 4328 bytes left. If you change a couple of parameters to tell the system you only have one drive you can free enough memory to have a total of 4622 bytes available.)

There is a short Basic program that you can run which throws away most of the DOS, leaving only the ability to Load from and Save to the disk, as well as access the disk from Basic programs. However, when you do this, you can't even look at the directory of the disk without running a special program, nor is it possible to save this small DOS so that you can "boot" from it, since the ability to write a DOS file went away when you threw out the menu. So, if you want to use "Tiny DOS", each time you boot the system you'll have to run the Basic program. In this "stripped down" mode you have about 9.4K available.

What can we say? Well, although the menu seemed friendly and handy at first, when you consider what it costs in memory taken, it may not be worth it. A more important issue is which DOS functions are crucial, and which can be shunted off into a separate 'disk utility'. Given the tight memory situation, we'd vote for the following as essential DOS functions, with everything else exiled to Siberia: Disk directory, delete file, and of course load and save files. These important DOS functions would ideally be direct commands, such as "DIR" or "CATALOG" for the directory.

Atari file names can only be UPPER CASE letters and digits. Why they chose such a restricted set is a mystery, since only comma, period, colon, asterisk and the question mark have special meaning to the DOS. File names consist of eight characters followed by a three character "extension".

Eight character names are too short to be really meaningful. (Just because CP/M and DEC made that mistake doesn't mean it should be repeated. Even Commodore allows 16 character names, and they can contain almost any characters you like.) Speaking of UPPER CASE, the 800 itself has a "feature" we find frustrating: it doesn't understand lower-case Basic keywords!

To summarize, we find many things about the system that we like, as well as some things that aren't what they could have been with a little better planning and design. Atari has put together a good system, one that we think will sell like gangbusters. It's available, now, at obscure places like Sears and J.C. Penny's and the like, as well as your friendly local computer store. ©

6502 MACRO ASSEMBLER AND TEXT EDITOR

- Versions for PET, APPLE II, SYM, KIM and ATAR I (1st quarter 1980)
- Written entirely in **machine language**
- Occupies 8K of memory starting at \$2000 — Apple version with disk occupies just over 9K
- **Macro** and conditional assembly
- 36 error codes, 26 commands, 22 pseudo ops
- Labels up to 10 characters
- Auto line numbering and renumber command
- String search and string search and replace
- Copy, move, delete, load, save, and append commands

Cassette and Manual \$49.95
(including U. S. postage)

Phone [919] 748-8446 or 924-2889

Eastern House Software

3239 Linda Dr.

Winston-Salem, N. C. 27106

THE PET[®] GAZETTE



Some comments on "NULL RETURN (INPUT) SIMULATION" in Compute #2.

Earl H. Wuchter
1610 Washington St.
N. Catasauqua, Pa. 18032

Oops!

W. M. Bunker (Lower Case Descention in Issue 2) writes:

Dear Mr. Lock:

I symphasize with your desire to improve program listings. Certainly the letters DN are more easily read than the Commodore symbol.

Unfortunately, Murphy's law assures us that any listing other than a copy of a program that actually ran -- WON'T RUN!

Two errors crept into your revision of my lower-case letter program. Line 600 needs the semicolon at the end. More subtle is the error in lines 440-470. If CC = 74 or does not equal 74, the program cannot reach 460. If you don't want to handle it as I did, the following will correct it:

```
440 IFCC<>74GOTO460
450 Q#=Q#+CHR$(254):GOTO470
```

With these two corrections, your version of the program will give the same results as mine.

Two additional changes that give a little improvement are to change the 5 in line 480 to a 4 and the 19 in line 620 to a 20.

We're considering listing Murphy as a staff member after Issue 2. We're learning as we go along however, and have updated our procedure.

1. If at all possible, we try to reproduce the actual program listing.
2. Where we can't do this, we've set our Spinwriter system up so it will actually print our reconstructed graphics and cursor controls for us. Our handshaking device between the Commodore and RS-232 Spinwriter is a dedicated Synertek SYM-1. Larry has it re-programmed to convert the outbound special characters to our symbol set. Now we can print the program that runs, rather than a copy we key in for printing purposes only. We're trying! Robert Lock

The PET INPUT statement functions as it does for two reasons: 1. Computers always do what they are programmed to do. 2. Computers do not always do what the programmer intended, especially when the code was written in machine language. The only question remaining is whether or not the programmer intended the statement to act as it does. In any case, the fact that inputting a null string sometimes causes an exit from a program and sometimes does not is a useful feature. A programmer has his choice.

Every PET programmer should be aware of this feature, and know how to use it, but the article with its muddled example program did nothing to help. The feature can best be explained as follows:

In order to have the INPUT statement accept a null string, it is necessary to precede the statement with some action that will put the "invisible cursor" (next print position) in the second-last column of a line so that the question mark and its following blank will force the blinking cursor to the first column of the next line. This can be done in a number of ways. From a new line (print position one), print a string containing 38 characters plus one more for each cursor-left in the string. The functions SPC(38) and TAB(38) can be used. A string containing nothing more than two cursor-lefts (cursors-left?) will also work. Whatever is printed must be followed by a semicolon.

```
100 REM SAMPLE
110 B$="PRESS RETURN"
120 PRINT B$ TAB(38);
130 INPUT A$
140 STOP
```

Another method of achieving the same end result is to prevent a null string by printing a string that ends with three cursor-lefts. The last character in the string will be input. Example:

```
222 INPUT"ARE YOU READY Y<<<";A$
```

This first of two parts presents the hardware requirements and overview of Cheep Print. In Issue 4, we'll present the software listing and documentation.
RCL

CHEEP PRINT

Hard Copy For Soft Cost

C. A. McCarthy
1359 W. Idaho Ave.
St. Paul, MN 55108

Cheep Print is a scheme. Its purpose is to give you hard copy at practically no cost. The principles are applicable to practically any microcomputer. The particular implementation described here is the one that I've developed for the Commodore PET.

For most of us, a printer is an expensive peripheral. Even if we manage somehow to scrape up the price of a printer, it can be difficult to choose between a printer, or more memory, a disc drive, or from a host of other goodies. And many of us aren't even so fortunate as to have such a choice to make. But hard copy is often very useful, and is sometimes practically indispensable. For example, when there is a bug lurking in a long program, a hard copy listing can let you examine widely separated portions of the code with an ease that even the best of screen editors can't match; or if you're short of memory, and don't have room for lots of REM's, you can comment a listing now, while the details are fresh in your mind, and then have a usable reference six months or a year from now; or if you have an opportunity to publish a program, you can generate a listing that is free of errors introduced by hand copying.

I had just those problems, and had been putting off developing software that I really wanted because I knew that I would be wasting too much time trying to remember what was where in the program; I'm simply not patient enough nor accurate enough to consider writing down a long program by hand with pencil and paper. Thus I developed the scheme presented here to get occasional hard copy. It has the advantage that it's free.

THE IDEA BEHIND CHEEP PRINT

The principal requirement of Cheep Print is that you have access to some printer that is hooked up to an acoustical coupler for use as a terminal which communicates over the telephone lines. What you do is

to use your computer to generate an audio signal that mimics the tones sent over the 'phone lines by a time-share system. Record these tones on any old cheap cassette recorder (mine cost less than \$20), then carry the recorder to the printer terminal and play back the cassette to the acoustical coupler. The printer thinks that some big bruiser of a mainframe is giving it orders, and it does as it's told. You get your hard copy. True, this isn't as convenient as having your own printer at home, but it sure beats having no hard copy at all. I used Cheep Print to develop itself, and I estimate that the time required was only a fourth of what it would have taken without the aid of hard copy.

HOW TO FIND YOUR PRINTER

The first question is where to find a printing terminal. At least locally, most schools from elementary to college have scads of terminals, usually teletypes, occasionally DECwriters. Typically, their principal use is for record-keeping and administration, possibly with some instructional use; but for much of the time, they stand idle. If you're a student or teacher, or know one well enough, then you have this source for a printer. Many businesses have such terminals, and I use one where I work, being careful not to interfere with people whose jobs require access to the terminal. Another possible source for a printer might be your local computer store. I should think that a right-thinking store would be willing to allow you to use its demonstrator printers at a nominal fee for paper and supervision, not only just to get you into the store so that you will buy other things, but also to get you hooked on hard copy so that you will someday want to buy your own personal printer from them; hard copy is indeed addictive, as I've found out for myself. Yet another source for a printer is your local computer club which may well have some members with usable terminals at home, or who could help in finding one for you to use.

The program and hardware that I have developed are specifically for the Commodore PET, simply because that's what I have. The ideas, however, are usable by any machine. All that is needed is some way to generate an audio tone of precise frequency and precise duration, and with the PET, this is a triviality due to the programmable timers and shift register (a 6522) that is available. Computers which have a 6530 or 6532 should also work well. The tones required are those of the Bell 103 standard which is universally used to send data over the 'phone lines at 110 to 300 baud. Although the 103 standard may seem to use strange and arbitrary frequencies, there are good reasons for them, and they are reliable even under poor conditions. My easy-to-understand source for these standards as well as the RS-232 serial data and ASC11 standards was Don Lancaster's TV Typewriter Cookbook. These standards are summarized in Table 1.



Skyles Electric Works

THANK YOU, COMMODORE 000

Just about a year ago, Skyles Electric Works introduced a 15 inch wide keyboard with all PET functions on nice, plump, full-sized keytops with torsion spring action. S.E.W. knew that most owners of the PET 2001-8 couldn't remain happy with the undersized keytops and unsatisfactory spring action.

Now you have announced that, effective in January of 1980, all PETs and CBMs would feature full sized keyboards.

So, thank you, Commodore, for confirming that S.E.W. was right all along.

Meanwhile, S.E.W. hasn't been resting...and now offers with the **Big KeyBoard** an 18 inch ribbon cable at no extra charge...and a cassette tape containing BASIC and machine language programs that convert the **Big KeyBoard** to ASCII or typewriter operation, including lower case characters, and upper case through the shift key. Even a shift lock, quotations in the proper place, numbers across the top row.

To complete the user's ability to use the **Big KeyBoard** as a high speed word and data entry keyboard, optional numerical keytops are available for placing over the top row of the Skyles keyboard at just \$9.00 for the ten keytops set.

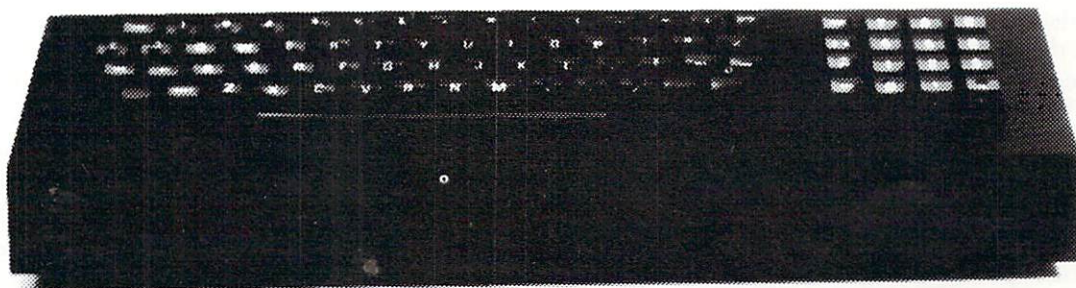

*All keytops double shot for lifetime durability. Switching action uses gold cross-point contacts; torsion springs are gold plated. Housing is black heavy gauge aluminum. Entire unit can be rinsed to clean under water and left to dry. 120 day warranty. **Only \$125.00*** with **COMPUTE-PON: \$99.50***

Wouldn't You Love Your PET 2001-8 Even More With the Skyles Big Keyboard?

**California residents: please add 6% or 6.5% sales tax as required.*

VISA, MASTERCARGE ORDERS CALL (800) 538-3083 (except California residents)

CALIFORNIA ORDERS PLEASE CALL (408) 257-9140



Skyles Electric Works

231 E South Whisman Road
Mountain View, CA 94041
(408) 735-7891

CHEEP PRINT Table 1

ASCII and Bell 103 standards

ASCII Serial Date

At 110 baud, the time for each bit is 9091 us

At 300 baud, the time for each bit is 3333 us

Data format:

- 0 a start bit, then
- x eight
- x data
- x bits,
- x least
- x significant
- x first,
- x
- x then
- 1 stop bits (two at 110 baud, one at 300 baud)
- 1
- 1 then mark time as required
- 1 until the next start bit
- 1 comes along

Bell 103 standards

Answer mode	Originate mode
2025 Hz means 0	1070 Hz means 0
2225 Hz means 1	1270 Hz means 1

HARDWARE REQUIREMENTS

The hardware that Cheep Print needs is simple and passive. A two wire cable to carry the computer generated audio tone to the cassette recorder is all that is needed; it plugs into the cassette AUX or MIC input. Figure 1 shows what is required. R1 should be at least 3.3 K ohm so that the 6522 VIA isn't overloaded, the decoupling capacitors C1 and C2 are just in case there are some unpleasant DC potential differences between the recorder and your computer, or across the recorder's input, and the low pass RC filter is to get rid of some of the square wave output's high frequencies that the recorder might not like. The signal that this records sounds awful: hum from four feet of unshielded cable, noise and distortion in generous amounts. Not unlike a poorish 'phone connection, which is what acoustical couplers are designed to cope with.

The second piece of hardware is optional, but highly recommended. It is just a telephone handset that plugs into the EAR or OUT jack on your recorder. You can, if you must, get by with just aiming your recorder at the acoustic coupler, but a sneeze may put unwanted characters on your hard copy, and the awful racket will make anyone else in the room loathe you. So invest in a telephone handset (the local price is four dollars on the surplus market), and follow Figure 2. The earpiece and mouthpiece caps unscrew and you will see that the wires to them are color coded. The wires to the earpiece should go to the recorder output, and the mouthpiece wires can be ignored or tied together to ground. A word of caution: not all handsets are the same size. Older handsets are just a little longer, and do not quite fit some of the newer couplers.

CHEEP PRINT Figure 2

Cassette to telephone handset interface

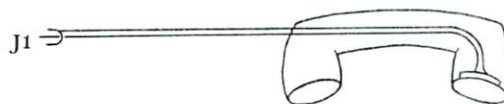

J1 Jack to cassette EAR or OUT socket. Usually a miniature phone plug.

A telephone handset is also what you need for PET to talk directly to an acoustical coupler, as shown in Figure 3. The resistor is to limit current, the capacitor is to eliminate any DC potential across the earpiece, and the back-to-back diodes are to eliminate any reverse voltage spikes that might be generated by inductance in the earpiece. The telephone handsets that I've inspected all have a little something across the earpiece terminals that behaves like two back-to-back diodes, but I'd rather not put my PET at the mercy of this undocumented whatzit. If you wish to send data over the 'phone lines, you might try this handset arrangement with the earpiece held in proximity to the mouthpiece of your home 'phone. The 1.6 ma. available from PET to drive the earpiece might be marginal over some 'phone lines, but a TTL output of 15 ma. or so would certainly put out enough sound if R1 were decreased to 200 ohms or so.

CHEEP PRINT Figure 1

PET to cassette interface

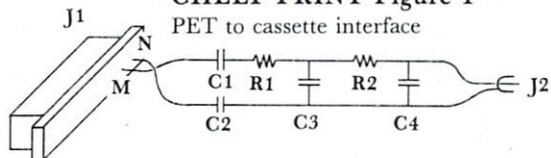

R1-C3 and R2-C4 products should be between .001 and .0001

C1, C2 .5 ufd or more

C3 .01 to .05 ufd

C4 .001 to .005 ufd

R1 3.3 to 10 Kohm

R2 10 to 100 K ohm

J1 Edge connector to PET parallel user port

J2 Jack to AUX or MIC input of cassette recorder. Usually this is a standard miniature phone plug, e.g. Radio Shack

CHEEP PRINT Figure 3

PET to telephone handset interface

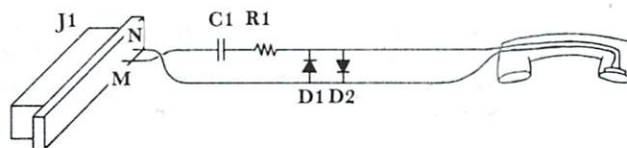

C1 .5 ufd or more

R1 3.3 to 3.9 K ohm

D1, D2 1 amp diodes, 1N4000 series

J1 Edge connector to PET parallel user port

FLOPPY DISK FOR PET, KIM, SYM, AIM - S100 EXPANSION

ALL IN ONE



The **PEDISK SYSTEM** from CGRS Microtech provides both a high speed FLOPPY DISK and an S100 EXPANSION chassis all in one! The FLOPPY DISK provides the PET computer with means to instantly load and save programs and information. Tired of waiting for your cassette? The optional S100 EXPANSION chassis gives the power and versatility of the S100 bus to the PET. The extensive and diverse product offerings on the S100 bus include Memory, I/O, Telephone Interface Cards, IBM Selectric Interface, Analog I/O, Voice Generators and even Voice Input Cards.

The **PEDISK SYSTEM** offers an economical solution to the problem of expanding the PET. It offers complete expansion capability in a single package. The FLOPPY DISK uses the IBM 3740 format to promote compatibility with other systems (Radio Shack). The S100 EXPANSION uses the most widely supported microcomputer bus in the industry. Standard, Economical Expansion - The **PEDISK SYSTEM**

The KM³ Software is furnished with each package and is available with the EXS100 Board. This software allows the user to LOAD, SAVE, RUN, and UPDATE files on the disk. In addition, Rev. 2 software will allow the user to OPEN, CLOSE, INPUT, and PRINT a disk file. The commands will execute directly or from a program.

- ADD I/O, VOICE, MEMORY
- LOAD, SAVE INSTANTLY
- PLUG-IN HOOK UP
- UP TO FOUR DISK DRIVES

COMPLETE SYSTEMS.....

PACKAGE 1 EXS100 DISK CONTROLLER MINIFLOPPY DISK DRIVE CABINET & DISK POWER SUPPLY **\$799.95**

PACKAGE 2 EXS100 COMBINATION DISK/S100 BOARD MINIFLOPPY DISK DRIVE CABINET & S100/DISK POWER SUPPLY 3 SLOT S100 CHASSIS **\$895.00**

PARTS.....

EXS100 BOARD

Assembled as an S100 Adaptor only \$199.95
Assembled as an Disk Controller only \$299.95
Combination Disk/S100 Board \$349.95



MICROTECH
P.O. Box 368
SOUTHAMPTON, PA. 18966
(215) 757-0284

*PET is a trademark of Commodore.

PET/CBM UNCRASHER™

WHAT IS IT? — UNCRASHER™ is a two button device that allows PET/CBM users to regain control of a cursor that's been lost due to programming errors. BASIC programs may be recovered. Machine language programs in the second cassette buffer are not disturbed either.

WHICH PETS/CBMs? — UNCRASHER™ is for all PET/CBM computers that use the "NEW" Version 2 ROMs. (Older model PETS should use the ITS NEW-CURSOR™.)

DOES IT WORK? — You bet!!! See the detailed review of the types of crashes and the concept of recovery in the first issue of *Compute*.

INSTALLATION — Simple, completely illustrated instructions using only a Phillips screwdriver ensure installation in minutes. No soldering or modifications to the computer.

OPERATION — Just follow the simple steps—push the buttons and reset the stack pointer—and PRESTO . . . recovery!

And all this happens without powering the PET/CBM down and up.

WHY UNCRASHER™? — No first class computer such as the PET/CBM should be without this capability. Whether your fancy be programming, business, education, or hobby, UNCRASHER™ saves you time by uncrashing your slip-ups.

AVAILABILITY — Now in better computer stores, or order direct from ITS, made by the people who brought you NEW-CURSOR™.

INTERNATIONAL TECHNICAL SYSTEMS INC.
P.O. BOX 264 WOODBRIDGE, VIRGINIA 22194
CUSTOMER SERVICES -
RICHMOND, VIRGINIA (804) 262-9709



PET RABBIT



Load, Save, Verify, Execute
8 K in 38 seconds versus
PETS 2 Minute 45 seconds,
plus more!

High-speed Cassette Routines work with 8K, 16K, or 32K **new ROM PETS** which have the new Commodore cassette deck (like the external version which sells for \$95.00). Note: If you have a new ROM PET with the old style lift-top deck, everything but the high-speed cassette routines will work.

- Auto repeat of any key held down, toggle character set.
- RAM Memory Test, convert #'s to hex and decimal.

12 Rabbit Commands

Note: Rabbit is 2K of machine code at \$1800 for 8K PETS, \$3000 or \$3800 for 16K PETS, or \$7000 or \$7800 for 32K PETS. (Specify one of the 5 versions.)

Cassette and Manual — \$29.95 (Add \$5.00 for foreign)

Eastern House Software

3239 Linda Dr. Winston-Salem, N. C. 27106
Phone [919] 748-8446 or 924-2889

POSSIBLE FURTHER DEVELOPMENTS

So that's Cheep Print. The natural question is what can one do to enhance it? The first things that come to mind are pretty big jobs and probably not worth the trouble except as a challenge to overcome: to make PET into a two-way terminal using an absolute minimum of hardware and doing all of the timing and decoding in software; or deciphering PET's internal tape writing routines enough so that you could make the internal cassette recorder produce tapes to Bell 103 or other standards. This has the advantage that you might not have to carry around your recorder to the printer; it has the disadvantage that you will probably sometime trash one of your PET program or data tapes. More modestly, a real convenience would be to attach something to one of your computer's other output lines that could turn off the cassette recorder when the job is done: the 300 baud output is quite slow, and my custom is to go do other things while the output is recording; when I get back to the computer, PET is idling patiently, but the cassette has come to the end of its tape and is protesting that it doesn't have an automatic stop. Probably the most significant program improvement that could be made would be to run the Cheep Print output on interrupts, interrupting whenever it was time to send out another data bit. This would really speed up the output, as the audio output to the cassette and the Basic character formatting would be running in parallel. The principal reason I haven't set up Cheep Print that way is that the PET documentation doesn't give any details on what other interrupts are active at various times, nor any inkling of the time required to service them. In the absence of such information, I think that it's better to have a mundane program that works, than a sophisticated program that may be erratic.

The Basic program that formats the output for the printer could also profit from some more work. It somehow just grew, and is the result of not knowing just what was desirable until a number of alternatives were tried out. It still is not wholly satisfactory to me, but it is adequate, and the job of cleaning up lines 46-49 will have to wait until I manage to dispose of more pressing matters.

Thanks are due to Jim Butterfield and Mark Zimmerman who provided useful comments and encouragement.

Happy printing!

©

Finally, MAE — A PET DISK-Based MACRO ASSEMBLER/TEXT EDITOR

Works with 32K PET

- Works with 2040 Disk, and can drive 2022/2023 Printer, and/or RS232/20 ma Device thru User Port.
- 100% Disk Based, 100% Machine Language.
- Macros, Conditional Assembly, and a new feature we developed called Interactive Assembly.
- Coexists with Basic, Auto character repeat, Sorted Symbol Table.
- 27 Commands, 26 Pseudo Ops, 5 Conditional Ops, 38 Error Codes.
- Creates relocatable object code on disk.
- Assemble from Memory or Disk.
- String search, search and replace, and inter-line edit.
- Auto line #-ing, move, copy, delete, renumber.
- Labels up to 31 characters — user specifies length.
- Includes extension to PET monitor (disassemble, trace, etc.), Library of PET ROM locations, Relocating Loader, plus more.

Manual, Diskette, U. S. postage — \$169.95
(Requires completion of License Agreement —
Write for details)

Eastern House Software

3239 Linda Drive

Winston-Salem, N. C. 27106

Phone [919] 748-8446 or 924-2889

DIAL-A-ROM™ for the Commodore PET

Switch between any one of six ROMs or PROMs (2708, 2716, 2732) such as Commodore's Word Pro and the Palo Alto IC's Toolkit. In attractive cabinet with dip plug to plug into empty PET ROM socket.

\$88.00 (US) + \$3.00 shipping

KOBETEK SYSTEMS LTD.
RR-1, Wolfville,
Nova Scotia, CANADA B0P 1X0
(902) 542-9100

Dealer Inquiries Invited

[Also for old 8K units]

PET SOFTWARE

LAS VEGAS CASINO SERIES:

These four programs were developed both as a tutorial for those planning to visit a Casino and wanting to learn to play correctly, and as a means for the serious gambler to develop and thoroughly test a gambling 'system' under actual Casino conditions. All betting odds and options available in the Casino of the MGM Grand Hotel in Las Vegas have been incorporated into these programs. Full screen graphics have been used to show the cards being dealt, the Roulette Wheel spinning, and the Dice being thrown in order to increase realism and heighten enjoyment.

1. **Casino Blackjack:**
For 1 to 5 players plus the dealer. Keeps track of winnings or losses for each player plus number of hands won, lost, and tied and the number of times the dealer and each player has busted. Play with 1, 2, or 4 decks. Change decks or reshuffle at any time. Split pairs, Double Down, or place an Insurance bet. Full Casino rules and many other options. \$ 7.95
2. **Casino Roulette:**
Bet on one number, two numbers, odd, even, black, etc. Watch the numbers come up as the wheel spins. Twelve ways to Bet \$ 7.95
3. **Casino Baccarat:**
James Bond's favorite game. Two games in one. Casino style and Blackjack style. Includes special features to help in developing a winning 'system' \$ 7.95
4. **Casino Craps:**
Bet the Dice to Pass or Fall Off. Bet the Hardway or Press with Double Odds. Ten ways to bet \$ 7.95

ADD SOUND TO YOUR PET:

5. **PET Tone Oscillator:**
Comes completely assembled with volume control and edge connector. Just plug into the User Port on your PET \$19.95
6. **Music Program:**
Plays music from the PET keyboard or from DATA Statements. Requires Tone Oscillator above \$ 7.95
7. **Morse Code Program:**
Let your PET teach you the Morse Code required for a Ham Radio license. Sends random letter groups or letters input from the keyboard. Speed variable from 3 to 25 WPM. Requires Tone Oscillator above \$ 7.95

STRATEGIC GAMES:

8. **Checkers:**
Play against the PET. PET plays a good, fast game according to International Checker Rules. Excellent graphics show the board and all checkers. Watch your PET move his man around the board. Clock shows elapsed time for each move. \$ 7.95
9. **Qubic-4:**
This is three dimensional Tic-Tac-Toe played on four, 4x4 boards. PET plays a fast exciting game choosing one of three strategies for each game. \$ 7.95
10. **Go Moku:**
Ancient Chinese board game played on a 9x9 board. Get 5 men in a row before your PET. A different strategy for each game \$ 7.95
11. **Othello:**
English game known as Reversi. Try to capture the PET's men before he captures yours. Play against the PET or against your friends. Fast and fun \$ 7.95
12. **Cribbage:**
An excellent version of this favorite card game. All cards are shown using PET's excellent graphics. The PET plays a cool logical game difficult to beat even for the best players. \$ 7.95

GUARANTEE: All programs are guaranteed to be free from errors and to load on any PET. Any defective tapes will be replaced free of charge.



CMS Software Systems

5115 MENEFFEE DRIVE • DALLAS, TX 75227



DIRECT SCREEN INPUT

Len Lindsay

You may think of the video on your PET as output only, but here is some news for you. You can use the video screen as input into your programs. The three program listings demonstrate this principle. Program #1 simply prints some DATA on the first five lines. It then loads in the next program.

Program #2 will read all five DATA lines and print the results. Program #3 asks you which piece of DATA you would like, and only inputs that piece. This is to demonstrate SELECTIVE screen input.

The first program is designed to run the next program immediately and expects the play button to be depressed on tape #1 (if it isn't the PRESS PLAY message will ruin the sequence). Thus SAVE program #1 on two tapes. Don't rewind the tape after the SAVE is through, but leave it positioned for the second program. On one tape SAVE the second program while on the other tape save the select program. Now either tape can be used to demonstrate the input from the screen principle.

This concept should also apply to the ATARI and I hope to find some time to try it out. Let me know of any uses you may find for this.

```

10 INPUT "[CLR]NAME ?( 3 LEFT)";N#
20 INPUT "SCORE ?( 3 LEFT)";S
30 INPUT "HIGH ?( 3 LEFT)";H
40 INPUT "LOW ?( 3 LEFT)";L
50 INPUT "[DOWN]AVERAGE ?( 3 LEFT)";A
60 REM *** THE ABOVE FIGURES COULD
70 REM *** HAVE BEEN GENERATED FROM
80 REM *** ANY PROGRAM
100 PRINT "[CLR]"; : REM CLEAR SCREEN
110 PRINT N#; : REM NAME
115 PRINT "," : REM END OF DATA MARK
120 PRINT S : REM SCORE
130 PRINT H : REM HIGH SCORE
140 PRINT L : REM LOW SCORE
150 PRINT A : REM AVERAGE SCORE
160 PRINT "[HOME]"; : REM HOME CURSOR
1000 LOAD : REM LOAD NEXT

```

```

10 CLR : REM CLEAR VARIABLES
15 REM : (WE DIDN'T CHEAT YOU KNOW)
100 OPEN 3, 3, 0 : REM OPEN SCREEN
120 INPUT#3,N# : PRINT : REM NAME
130 INPUT#3,S : PRINT : REM SCORE
140 INPUT#3,H : PRINT : REM HIGH
150 INPUT#3,L : PRINT : REM LOW
160 INPUT#3,A : REM AVERAGE
199 CLOSE 3
200 PRINT "[HOME]C 16 DOWN]";
210 PRINT "WELL ";N#;" YOUR SCORE WAS";S
220 PRINT "YOUR PREVIOUS HIGH WAS";H
230 PRINT "YOUR PREVIOUS LOW WAS";L
240 PRINT "YOUR AVERAGE IS NOW ";A

```

```

10 CLR : REM CLEAR VARIABLES
15 REM : (WE DIDN'T CHEAT YOU KNOW)
100 OPEN 3, 3, 0 : REM OPEN SCREEN
105 REM PUT CURSOR BELOW LAST DATA
110 PRINT "[HOME]C 6 DOWN]";

```

```

120 PRINT "WHICH DO YOU WANT TO INPUT"
130 A#(1)="NAME" : A#(2)="SCORE" : A#(3)="HIGH"
135 A#(4)="LOW" : A#(5)="AVERAGE"
140 FOR X=1 TO 5 : PRINT A#(X) : NEXT
150 GET C# : IF C#="" THEN 130
155 PRINT "[HOME]";
160 FOR X=1 TO 5
165 IF C#=MID$("NSHLA",X,1) THEN 900
170 PRINT : NEXT
180 GOTO 110
900 INPUT#3,A#
910 PRINT "[HOME]C 15 DOWN]";
920 PRINT A#(X);" IS ";A#
999 CLOSE 3

```

NO CB2 SOUND?

Larry Isaacs

Some of you may have been unable to get the CB2 Sound, described in last month's RAMBLIN', to function. Fortunately the most likely cause has a very simple solution. Unplug the external cassette from the rear of your PET. Having an idle cassette plugged into that cassette port grounds the CB1 line on the 6522 IC in the PET. Grounding CB1 unfortunately stops the shifting of the shift register used to generate the CB2 Sound.

I also checked a Synertek 6522 (PETs use MOS Technology) and found that it had the same problem. It appears that this is inherent in the design of the 6522, so keep it in mind when using the shift register for output.

BRAND NEW !!

Programs for Commodore's PET®

- **Business Research** \$50
Make better decisions with this high power MBA business tool. 16k.
- **Home & Small Business** \$15-\$25
● Addresser ● Inventory
● Shopper ● Dinner's On!
Each has a built-in printer option.
- **Games & Simulations** \$15ea.
● Fur Trapper ● High Seas
● Mansion! ● Pentagon! ● Museum!
- **Education Pack** \$15
High School sampler with geometry, algebra & chemistry.

Send for full catalog!



HARRY H. BRILEY
P.O. Box 2913
Livermore, CA 94550
(415) 455-9139



Said the Toolkit to the Word Processor: "You're in My Space!" Said the Word Processor to the Toolkit: "Let's Share...here's

Socket 2 Me™!"

From the original producer of peripherals exclusively for PET lovers everywhere . . . the device that allows you to select between the BASIC Programmer's Toolkit and the Commodore Word Processor II while they occupy the same address space.

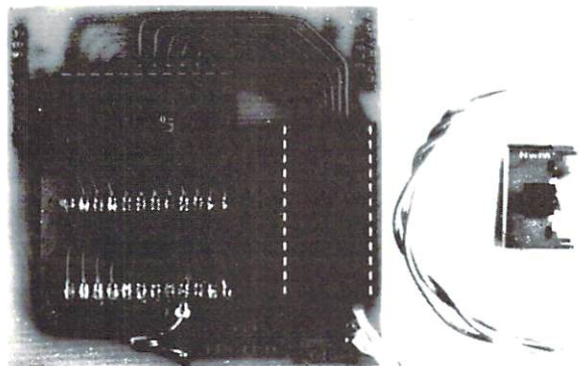

The **Socket 2 ME** . . . doubles your memory expansion in a single socket. It's a 2.5" x 2.75" board that fits neatly into the Toolkit/Word Processor socket on the main logic board of all *new* PETs. Then both the Word Processor and the Toolkit plug into the **Socket 2 ME**.

A miniature slide switch — part of the kit — mounts with double-stick tape (supplied) to the front part of the right side of the PET base, almost hidden by the overhang of the top of the PET cabinet. The slide switch is connected to the **Socket 2 ME** by a special cable (also supplied) . . . and you're up and running.

Up and running; installation took only a minute or so. Flip the switch from Toolkit to Word Processor. And back. No need to open the PET.

Complete with the first-rate installation and operating instructions you've come to expect from all Skyles documentation.

YOU HAVE AN ORIGINAL 2001-8 PET ?

No problem. The **Socket 2 ME** interfaces with the BASIC Programmer's Toolkit model TK 160E or TK 160S connector board, the Word Processor II interfaces with the **Socket 2 ME**, the slide switch is placed on the PET base. Then, as long as the PET 2001-8 has at least 8K of memory expansion, the system is up and running.

YOU HAVE A COMPUTHINK DISK AND YOU WANT A BASIC PROGRAMMER'S TOOLKIT?

How would you like to switch between the Computhink and the Toolkit with a single SYS command?

Just add two small jumpers to the Computhink system and a short program to the DOS diskette. Plug in the BASIC Toolkit TK 80E, enter the **SYS** command and your system is up and running.

NO ROOM ON THE PET 2 COMPUTHINK DISK BOARD?

All your sockets are booked? Fret not; Skyles comes to the rescue. **Skyles Electric Works** now has a modified EPROM board available with sockets for the Toolkit and Computhink ROM chips. Plug in the ROMs, add a jumper (supplied) to the PET 2 Computhink disk board, plug the new EPROM board into the Computhink disk board. Power up and enter a short switching program into the DOS diskette. Switch between the Computhink disk and the Toolkit with a single **SYS** command.

ORDER NOW — with Skyles' 10-day money-back guarantee:

Socket 2 ME: \$\$22.50*
Commodore Word Processor II: \$100.00*
Commodore Word Processor III: \$200.00*

BASIC Programmer's Toolkit
Model TK 80ED \$85.00*
Model TK 160ED \$95.00*†

*Add \$2.50 to each for shipping and handling.

†Note: If Computhink EPROM board is returned, after purchase of TK 160ED, Skyles will refund \$20.00.

"Socket 2 ME" is the trademark of Skyles Electric Works.

California residents: please add 6% or 6.5% sales tax as required

VISA, MASTERCARD ORDERS CALL (800) 538-3083 (except California residents)

CALIFORNIA ORDERS PLEASE CALL (408) 257-9140



Skyles Electric Works

231 E. South Whisman Road
Mountain View, CA 94041
(408) 735-7891



A VERSATILE SERIAL PRINTER INTERFACE FOR THE PET

Harvey B. Herman
Charles B. Pate*
Chemistry Department
University of North Carolina at
Greensboro, North Carolina 27412

Several articles have appeared describing serial and parallel printer interfaces for the PET (1-3). In our opinion each method had advantages and disadvantages. We decided to combine the best features of each into a simple design for a serial interface and this article details the project.

The interface is connected to the IEEE and User ports of the PET computer. It incorporates a hardware UART for parallel-to-serial conversion of data on the IEEE buss. The UART clock is provided by the CB2 square wave output of the User port (2). Additional control of the UART (stop bits, number of data bits, parity, etc.) is accomplished under software control, with other bits from the User port. We used an idea by Edward Comber, published in our local club newsletter (3), to strobe the UART only when data appears on the IEEE bus. Address information, if not ignored, prints as data and messes up otherwise nice printouts.

The interface circuit (shown in figure 1) was easy to build. We used a 22 pin circuit breadboard from Radio Shack (other brands will do) and soldered the IEEE edge connector directly to its pins. The User port connector was put on a cable harness since the breadboard could not accommodate the connectors for both ports. Connections were made to wire wrap sockets and pins using a manual wire wrap tool (Vector P160-2A-1). Power was supplied by a calculator charger and 5V three terminal regulator. No other power supply was required as the UART used only 5V.

The interface was tested with an older model DEC writer (LA30) at 300 baud. Other terminals and baud rates could be accommodated easily by modification of the control software below. The following sequence of POKEs was used to set up the UART properly before printing on the terminal:

POKE 59459,255	Set data direction (out)
59471,109	Pulse master reset
59471,45	and set output bits

59467,16	300 Baud 16X clock
59464,24	out CB2 (See reference 4
59466,51	for other baud rates)

An example of how we arrived at 109 and 45 for location 59471 is shown in Table 1. The printer we used required a delay after carriage return. In lieu of the CMD command, which does not provide a delay, we used the following POKEs (5) (old ROM):

POKE 612,5	Output to IEEE bus (device #5)
4,3	Set number of Nulls to 3
LIST	
POKE 612,3	Output restored to screen (device #3) when done with printer

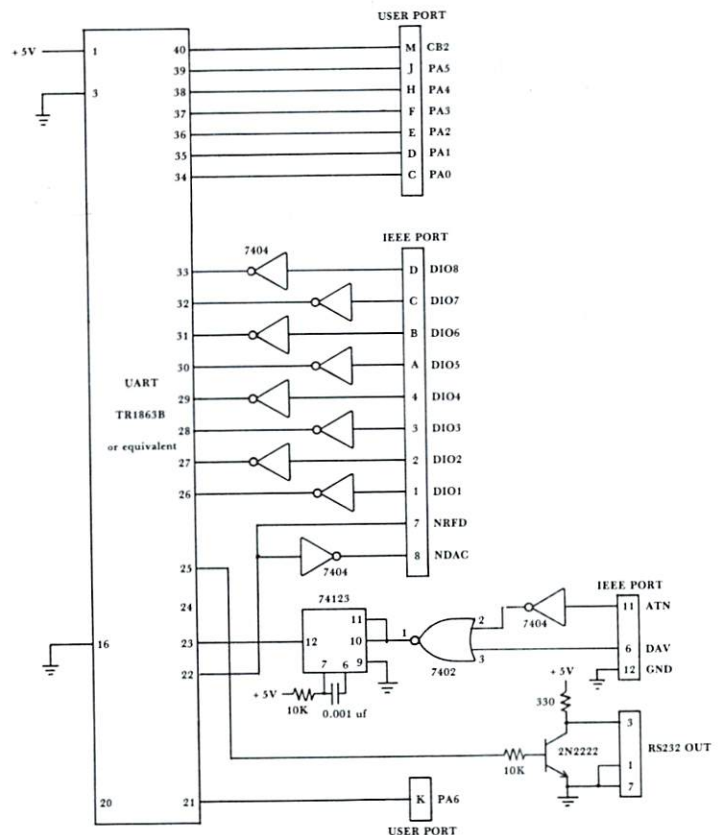

Before loading a new tape it is necessary to stop the 16X clock by POKeing 59467 with zero. Remember to restore output to the screen before this or the PET will hang up trying to print a message with no UART clock. We found it was possible to recover from this condition by turning power to the interface off. However, I would not recommend using this as a routine procedure.

The advantages of this circuit are that many of the important UART settings are under software control. It is not necessary, for example, to adjust a potentiometer or solder a different resistor when the baud rate needs to be changed. Certainly the low



Said the Toolkit to the Word Processor: "You're in My Space!" Said the Word Processor to the Toolkit: "Let's Share...here's

Socket 2 Me™!"

From the original producer of peripherals exclusively for PET lovers everywhere . . . the device that allows you to select between the BASIC Programmer's Toolkit and the Commodore Word Processor II while they occupy the same address space.

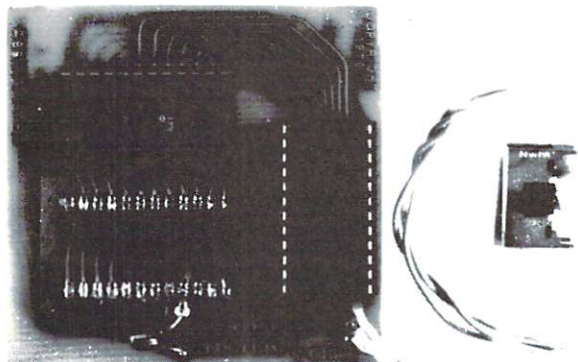

The **Socket 2 ME** . . . doubles your memory expansion in a single socket. It's a 2.5" x 2.75" board that fits neatly into the Toolkit/Word Processor socket on the main logic board of all *new* PETs. Then both the Word Processor and the Toolkit plug into the **Socket 2 ME**.

A miniature slide switch — part of the kit — mounts with double-stick tape (supplied) to the front part of the right side of the PET base, almost hidden by the overhang of the top of the PET cabinet. The slide switch is connected to the **Socket 2 ME** by a special cable (also supplied) . . . and you're up and running.

Up and running; installation took only a minute or so. Flip the switch from Toolkit to Word Processor. And back. No need to open the PET.

Complete with the first-rate installation and operating instructions you've come to expect from all Skyles documentation.

YOU HAVE AN ORIGINAL 2001-8 PET ?

No problem. The **Socket 2 ME** interfaces with the BASIC Programmer's Toolkit model TK 160E or TK 160S connector board, the Word Processor II interfaces with the **Socket 2 ME**, the slide switch is placed on the PET base. Then, as long as the PET 2001-8 has at least 8K of memory expansion, the system is up and running.

YOU HAVE A COMPUTHINK DISK AND YOU WANT A BASIC PROGRAMMER'S TOOLKIT?

How would you like to switch between the Computhink and the Toolkit with a single SYS command?

Just add two small jumpers to the Computhink system and a short program to the DOS diskette. Plug in the BASIC Toolkit TK 80E, enter the **SYS** command and your system is up and running.

NO ROOM ON THE PET 2 COMPUTHINK DISK BOARD?

All your sockets are booked? Fret not; Skyles comes to the rescue. **Skyles Electric Works** now has a modified EPROM board available with sockets for the Toolkit and Computhink ROM chips. Plug in the ROMs, add a jumper (supplied) to the PET 2 Computhink disk board, plug the new EPROM board into the Computhink disk board. Power up and enter a short switching program into the DOS diskette. Switch between the Computhink disk and the Toolkit with a single **SYS** command.

ORDER NOW — with Skyles' 10-day money-back guarantee:

Socket 2 ME: \$22.50*
Commodore Word Processor II: \$100.00*
Commodore Word Processor III: \$200.00*

BASIC Programmer's Toolkit
Model TK 80ED \$85.00*
Model TK 160ED \$95.00*†

*Add \$2.50 to each for shipping and handling.

†Note: If Computhink EPROM board is returned, after purchase of TK 160ED, Skyles will refund \$20.00.

"Socket 2 ME" is the trademark of Skyles Electric Works.

California residents: please add 6% or 6.5% sales tax as required

VISA, MASTERCARD ORDERS CALL (800) 538-3083 (except California residents)
CALIFORNIA ORDERS PLEASE CALL (408) 257-9140



Skyles Electric Works

231 E. South Whisman Road
Mountain View, CA 94041
(408) 735-7891



A VERSATILE SERIAL PRINTER INTERFACE FOR THE PET

Harvey B. Herman
Charles B. Pate*
Chemistry Department
University of North Carolina at
Greensboro, North Carolina 27412

Several articles have appeared describing serial and parallel printer interfaces for the PET (1-3). In our opinion each method had advantages and disadvantages. We decided to combine the best features of each into a simple design for a serial interface and this article details the project.

The interface is connected to the IEEE and User ports of the PET computer. It incorporates a hardware UART for parallel-to-serial conversion of data on the IEEE buss. The UART clock is provided by the CB2 square wave output of the User port (2). Additional control of the UART (stop bits, number of data bits, parity, etc.) is accomplished under software control, with other bits from the User port. We used an idea by Edward Comber, published in our local club newsletter (3), to strobe the UART only when data appears on the IEEE bus. Address information, if not ignored, prints as data and messes up otherwise nice printouts.

The interface circuit (shown in figure 1) was easy to build. We used a 22 pin circuit breadboard from Radio Shack (other brands will do) and soldered the IEEE edge connector directly to its pins. The User port connector was put on a cable harness since the breadboard could not accommodate the connectors for both ports. Connections were made to wire wrap sockets and pins using a manual wire wrap tool (Vector P160-2A-1). Power was supplied by a calculator charger and 5V three terminal regulator. No other power supply was required as the UART used only 5V.

The interface was tested with an older model DEC writer (LA30) at 300 baud. Other terminals and baud rates could be accommodated easily by modification of the control software below. The following sequence of POKEs was used to set up the UART properly before printing on the terminal:

POKE 59459,255	Set data direction (out)
59471,109	Pulse master reset
59471,45	and set output bits

59467,16	300 Baud 16X clock
59464,24	out CB2 (See reference 4
59466,51	for other baud rates)

An example of how we arrived at 109 and 45 for location 59471 is shown in Table 1. The printer we used required a delay after carriage return. In lieu of the CMD command, which does not provide a delay, we used the following POKEs (5) (old ROM):

POKE 612,5	Output to IEEE bus (device #5)
4,3	Set number of Nulls to 3
LIST	
POKE 612,3	Output restored to screen (device #3) when done with printer

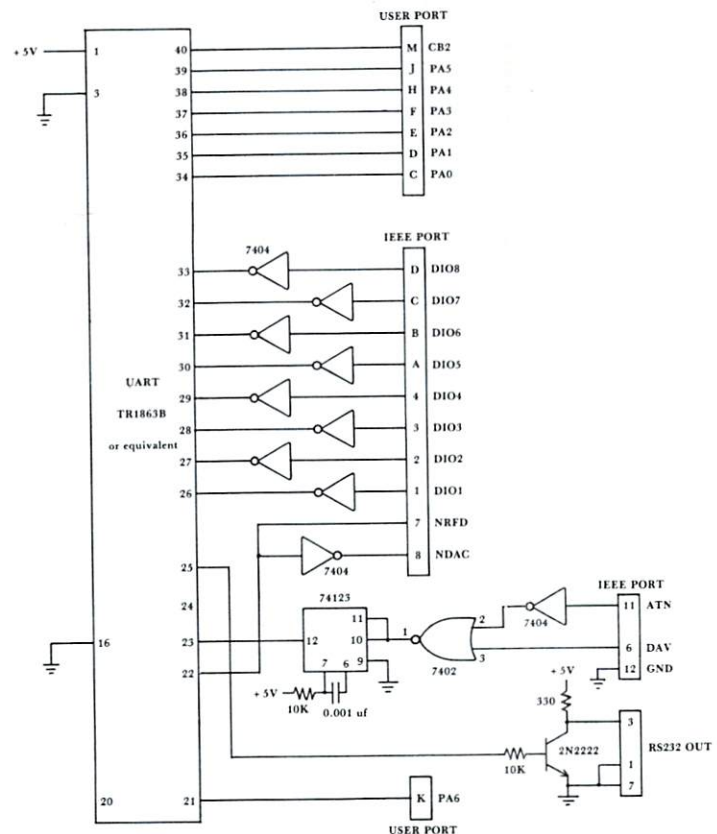

Before loading a new tape it is necessary to stop the 16X clock by POKeing 59467 with zero. Remember to restore output to the screen before this or the PET will hang up trying to print a message with no UART clock. We found it was possible to recover from this condition by turning power to the interface off. However, I would not recommend using this as a routine procedure.

The advantages of this circuit are that many of the important UART settings are under software control. It is not necessary, for example, to adjust a potentiometer or solder a different resistor when the baud rate needs to be changed. Certainly the low

price for just the components is a decided plus. However, if money is no object or you are tired of solder burns on your fingers or clothes, I would recommend purchasing any one of the several commercial designs (6) some of which have two way communications.

**On leave from Salem College, Fall, 1979.*

References

1. Prentice Orswell, PET User Notes, Vol. 1, #5, p. 13, "IEE/RS-232 Printer".
2. W. Hawes, The Transactor, Vol. 2, #2, p. 6, "PET to Teletype Interface".
3. Edward Comer, Triad Amateur Computer Society Newsletter, Vol. 2, #6, p. 2, "Budget PET Printer".
4. J. R. Kinnard, PET User Notes, Vol. 1, #3, p. 2, "Generating Square Waves with the PET".
5. Jerry Anonymous, The PET Gazette, Summer, 1979, p. 40, "Adding Nulls after Return".
6. A. Connecticut MicroComputer, Inc., ADA 1200, \$169
B. TNW, TNW-2000, \$229 (2 way communication).
C. Computer Associates, LTD, PET RS-232C Serial Adapter \$225 (2 way communication).
7. Western Digital Corporation, Data Sheet for TR 1863A/B.

TABLE 1

Output Control Settings and Example

UART pin # (Ref. 7)	User Port Label	Function
34	PA0	Control Register Load (CRL)
35	PA1	Parity Inhibit (PI)
36	PA2	Stop Bit(s) Select (SBS)
37/38	PA3/PA4	Word Length Select (WLS ₂ /WLS ₁)
39	PA5	Even Parity Enable (EPE)
21	PA6	Master Reset (MR)
40	CB2	Transmitter Register Clock (TRC)

Example - clear logic and set registers

	PA6	5	4	3	2	1	0	Decimal	Hex
POKE 59471	1/0	1	0	1	1	0	1	109/45	6D/2D

Parts List

- 2 7404 (hex inverter)
- 1 7402 (quad NOR)
- 1 TR1863B (UART)
- 1 74123 (one shot)
- 1 2N222 (NPN transistor)
- 2 10K ohm resistor
- 1 330 ohm resistor
- 2 0.01 uF disk capacitor (decoupling)
- 1 0.001 uF disk capacitor (one shot)
- 1 7805 (5V regulator)
- 1 6V AC adapter (actually 9V DC/300 mamp)
- 1 DB-25S Connector (25 pin female)
- 2 User Port/IEEE Connector (12/24 pin edge)
- 1 circuit bread board (Archer 276-157)

©

P.S. Software House

New: WORD PROCESSOR \$14.95

We've written a fast mini **Word Processor** that we believe is the best on the market in its price range. This electronic typewriter program, designed especially for the Commodore printer, works well with most other printers.

Features:

- Centering
- Right Margin Justification
- Repeat
- Tab
- Save and Load Data
- Editing
- Multiple Copies

Machine Language Utility Pac for the serious programmer \$29.95

Eight programs in one:

- Complete extended monitor
- Tape Relocate
- Basic Renumber
- Disassembler
- Screen Print Program
- Hex to Decimal and Decimal to Hex Conversion
- Basic Merge
- Program is self-relocatable

New: Trigonometry \$9.95

Of special interest to educators, engineers, scientists, etc. **Not a game!** This professionally written program with graphics is designed to take the burden out of trigonometric calculations. Given any three quantities of a triangle, the three unknown quantities will be instantly calculated and printed. Internally protected against illegal entries.

Our Best Seller! \$9.95 Mail List

Store names and addresses for Business, Inventory, anything you may need recorded. Perfect for card lists, clubs, etc.

Send for your free catalogue. ROM listings for the new PET are now available. \$21.95
P.S. Software House, P.O. Box 966, Mishawaka, IN 46544

Order by Mail or Phone - We accept Visa & Master Charge - (219) 255-3408 Hours: 8-5 EST.

RAMBLIN'

Roy O'Brien



BAR CHARTS ~ EVEN IF YOU NEVER USE 'EM, THEY PROVIDE AN INTERESTING INSIGHT INTO THE ARCAINE WORLD OF SCREEN POKING UNDER PROGRAM CONTROL...

HERE'S A ROUTINE, (ADAPTED FROM THE TIS WORKBOOKS), WHICH WILL PLOT A VERTICAL HISTOGRAM OF TWENTY BARS, DRAWING FROM THE BOTTOM UP. (X% IS AN INTEGER REPRESENTING X-AXIS (LEFT-RIGHT) POSITION, AND Y% IS THE HEIGHT OF A BAR)

REMEMBER, THE SCREEN CONTAINS 25 LINES OF 40 CHARACTERS EACH, STARTING WITH ADDRESS 32768 AT TOP LEFT, ENDING WITH 33767 AT BOTTOM RIGHT:

```

200 FOR I=1 TO 20           (SETS UP NUMBER OF BARS)
210 X%=I*2-1               (FINDS POSITION ON X-AXIS)
220 FOR J=1 TO Y%(I)       (SETS UP LOOP FOR HEIGHT OF A BAR)
230 POKE 32768+((25-J)*40+X%),102 (POKES SYMBOL INTO PROPER PLACE)
240 NEXT J                 (GO BACK TO 230 IF MORE HEIGHT NEEDED)
250 NEXT I                 (GO BACK TO 210 AND START NEXT BAR)
    
```

LINE 230 IS THE FAMILIAR POKE A,B STATEMENT, WHERE A IS THE ADDRESS TO BE POKED, AND B IS THE 'DATA'; IN THIS CASE 102, WHICH IS THE CODE FOR █.

THE EXPRESSION BEFORE THE COMMA CALCULATES AN ADDRESS IN THE SCREEN MEMORY AREA.

STARTING FROM THE UPPER LEFT OF THE SCREEN & DROPPING DOWN, (25-J)*40 FINDS SUCCESSIVELY HIGHER LINES; ADDS X% TO GET THE CORRECT DISTANCE TO THE RIGHT, AND POKES THE GRAPHIC CHARACTER.

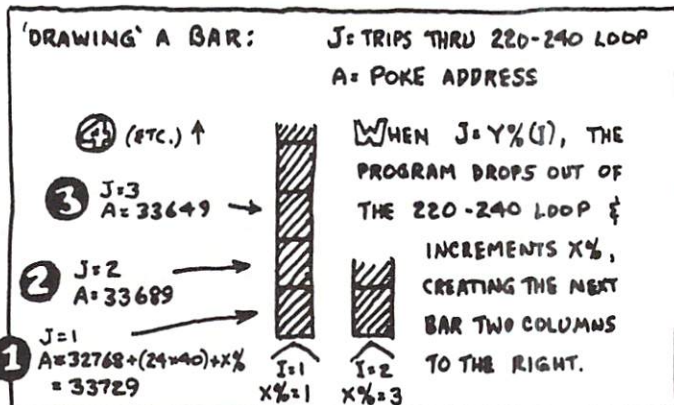

HOW DO YOU ENTER THE BAR HEIGHTS? WELL, YOU COULD USE THE INPUT STATEMENT, OR READ... DATA. IN ANY CASE, FOR MORE THAN 10 BARS, YOU MUST USE A DIM STATEMENT TO SET UP ENOUGH SUBSCRIPTED VARIABLES...

```

50 PRINT "█"              (CLEAR SCREEN)
100 DIM Y%(20)            (SETS UP ARRAY; % FORCES INTEGERS)
110 DATA 5,15,12,etc. (ANY 20 NUMBERS, 0 TO 25) *
120 FOR I=1 TO 20        (SETS UP SUBSCRIPTS)
130 READ Y%(I)          (READS DATA INTO VARIABLE)
140 NEXT I               (GO BACK 'TIL DONE)
150 clear GO TO 260      (KEEPS 'READY' OFF SCREEN)
    
```

* **T**O GET REAL DATA INTO THE 0-25 RANGE, DIVIDE BY AN APPROPRIATE NUMBER (KEEPS PROPORTIONS), OR SUBTRACT A CONSTANT (EMPHASIZES DIFFERENCES), OR USE A COMBINATION, TO GET THE SCALING YOU WANT.

BONUS ~ FOR HANDY REFERENCE, COPY, CUT & TAPE THESE CURSOR CONTROL SYMBOLS TO YOUR PET:

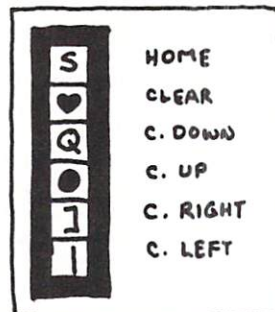

Review:

MAE, A PET Disk-based Macro Assembler

Eastern House Software \$170.00

3239 Linda Drive

Winston-Salem, NC 27106

Reviewed by James Strasma

120 West King St. Decatur, IL. 62521

I am still very pleased with Carl Moser's ASM/TED assembler after using it for 8 months. MAE, Moser's latest effort, goes far beyond ASM/TED's capabilities. It is entirely disk-based, compatible with CBM and other printers, accepts an external keyboard, and offers many other features in use, not shared by ASM/TED.

MAE is sent on diskette, along with DOS 4.0, Extramon (see separate review), and a relocating loader. Sample programs included are: a relocatable version of the relocating loader, a library of PET ROM routines, 4 source files that MAE will assemble into a bidirectional software UART, and some last minute notes on using MAE.

The 44 page manual was written using MAE, and printed on a CBM printer. Judging from the results, MAE is all the word processor many of us need. The manual is only for the PET version of MAE. A table of contents fills the cover, and everything is well organized and easy to find. Pages are of very heavy paper for long use. There are 3 pages of practical examples, illustrating the use of many MAE features, and a detailed guide to getting started with MAE. The few minor errors I noticed are not likely to confuse anyone.

I won't describe features MAE shares with ASM/TED. These are reviewed in the Summer, 1979 issue of "Pet Gazette", and the Fall, 1979 issue of "Compute". Except for the lack of cassette routines (see below), MAE is superior to ASM/TED in every way. Nearly all ASM/TED "bugs" have been eliminated. Only a few concerns remain: 1)neither assembler can define a label as the high part of another label, 2)graphics characters are converted to non-graphic equivalents, 3)the input default is decimal while the output default is hex, 4)zero page modes must be specified, and 5)neither assembler is relocatable easily.

Fortunately, MAE is well located as sent. It can share memory with all of the other programs on the disk and a fair amount of object code. On request, Carl Moser sent me a list of key locations within

MAE. He intends to maintain and improve MAE for his customers at a reasonable cost, as he has already with ASM/TED. He also wants users to share interchangeable modules of MAE code, and is writing a book to aid in programming at the macro and file level. Anyone interested in an ASM/TED or MAE users group is welcome to contact me. I'd like to see one organized.

MAE includes at least 9 new features: First, it coexists with Basic. Second, it has an automatic repeat function. Third, it talks to CBM or serial ASCII printers, or both at once, and listens to ASCII keyboards, all at any reasonable baud rate. (I didn't test the serial functions though.) Fourth, it will accept labels of any length up to 31 characters. Fifth, by varying label length, MAE can generate neat listings from 40 to 80 characters wide. Sixth, labels are sorted alphabetically. Seventh, MAE accepts user input during assembly. Eighth, it allows files to call each other. And ninth, it is able to relocate different aspects of a relocatable file to differing parts of memory.

MAE is a joy to use. It interacts beautifully with the 2040 disk. The only problem I found has already been corrected. I tried valiently to "crash" MAE, but was unable to do so. Should you buy it? That depends...

Mr. Moser is his own only competitor. If you want an assembler, you really have 3 choices written in machine language, all by Moser. Of those, ASM/TED is the obvious choice for the occasional user with 16k of memory and either ROM set, who doesn't mind the lack of disk and printer capability. Macrotea, an enhanced version of ASM/TED, by Skyles Electric Works, is the only one likely to work with 8k pets, or with both disk and cassette. Because it is in ROM, all of memory is free for other things, and it includes added memory of its own. On the other hand, it ties up ROM space that the Word Pro and Basic Toolkit ROMs would use. It also lacks the new features of MAE, and doesn't include all of Extramon (see separate review). At \$375 +, it is also the most costly way to assemble with Moser. Be sure it actually exists and works before ordering it.

If you have a 32k PET and \$170, your best bet is probably MAE. Even without a disk, MAE is usable, as follows: Find a 2040 disk long enough to load the MAE programs into memory. Then also load a file disk. Then break to the monitor, and save \$0500 to 8000 from the monitor. From then on, use MAE normally, omitting disk commands. To save a file, break to monitor and save \$3000 to 7800 (or more). Resume with a warm start next time. Eventually you'll probably want a disk, and the temporary inconvenience will save a later upgrade expense. MAE works well with my business keyboard, and I can't imagine a better assembler for my purposes. I recommend it highly. ©

REVIEW:

The PET RABBIT

reviewed by James Strasma

**Eastern House Software, 3239 Linda Drive,
Winston-Salem, NC 27106 \$29.95**

The PET Rabbit is an extension of the Commodore PET operating system. It is designed to quadruple cassette load, save & verify operations. The present version is for 16/32k CBM/PETs with new ROMs. According to the author, an old ROM version is planned.

As those who have loaded large programs into a 32k PET already know, the 2¼ minutes it takes to load a large 8k program are a minor irritation. A 28k program can take over 9 minutes--and what if it should end with a "Load Error"? Now there is an alternative.

Rabbit is 2k of machine language programming appended to a brief Basic program. When run, Rabbit hoists itself into high memory, & adds several commands to Basic. The three pages of instructions which come with Rabbit are fairly adequate. I won't repeat them here. Instead, here are the options briefly stated:

- * by itself, jumps to the ROM monitor.
- Otherwise signals a Rabbit command
- s saves a program, with or without a long leader tone
- l loads a Rabbit program
- v verifies a program
- e loads & immediately executes a program
- h translates a hex number into decimal form
- d translates a decimal number into hex
- z flips graphics & lower case character sets
- g jumps to a machine language program
- t does either of 2 memory tests
- k disables the Rabbit

Finally, there is an automatic repeat of any key held down a ½ second.

Rabbit has many fine features; it also has some problems. I will deal with the problems first:

1. The 32k version does not execute at the top of memory. It ends 2k below hi-mem. This wastes memory unless you have another program to put in the top 2k of memory. With some difficulty, I relocated my copy to the actual top of memory. I sent a copy of that version to the author, so it may now be available that way upon request.
2. Loading Rabbit destroys any Basic program already in memory. A totally machine-language version could have loaded directly into high memory using the ROM monitor, without harming most Basic programs already resident.
3. Until the load is finished, Rabbit gives no indication that it has found a program. I wasted a good ½ hour once, trying to load a regular PET tape with the

Rabbit's *1 command. It was my mistake, but there was no message to advise me of my error. (PET & Rabbit can't read each other's tapes.)

4. Rabbit's flag "***", is a shifted character on business-keyboard CBMs. This means an extra key-stroke with every command. Fortunately, this is easily changed. After loading Rabbit but before running it, poke location \$055B hex with the ascii value of any character you'd rather use. (I use \$40, the "@" sign, unshifted on all PETs.) Then save the resulting program like any Basic program.
5. Rabbit needs 45 seconds to load, and is not ROM-able as sent. Thus, time savings are insignificant on the first small program loaded after resetting PET. I've only converted programs larger than 8k to Rabbit format.

Now for the good points:

1. It works! It is a full four times as fast as the built-in cassette routines. This also means a saving of tape. A 32k program will fit twice on one side of a C-10 tape in Rabbit format. Also, an "end of tape" mark takes only a couple of seconds to write.
2. Rabbit is hard to crash. Not impossible, but difficult. Even if "killed", it can be restored merely by changing one jump instruction in page zero to point at the Rabbit again.
3. The repeat key is VERY handy when writing programs, & even works during running programs. A nice touch is that the cursor ALWAYS flashes as it moves--no guessing about the current location.
4. The number conversions are also useful, especially when interfacing Basic & machine language programs.
5. The quick access to the monitor & the alternate character set is a pleasant convenience, as is the ease in jumping to a machine language program.
6. Though seldom needed, the 2 memory tests seem quite thorough, & fast. In 20 minutes, over 30,000 locations may be filled with every possible op code & verified.
7. Rabbit includes diagnostics. An up arrow appears below a faulty Rabbit command line, at the point the error was discovered. There are also added messages in case of errors. If there isn't enough room for a program, for instance, Rabbit will say so, instead of trying anyway, like ordinary PETs. When a load or verification is complete, the actual hex addresses & space used by a program are displayed, along with its title.

On balance, I recommend Rabbit for those 16/32k PET owners without a disk system. Thirty dollars is no giveaway, but it is far less than the \$1,300 for the 2040 disk. Despite the slight hassle of loading it in each day, you will find yourself using it regularly & gladly. It is entirely compatible with PET's regular cassette commands, adding to, not replacing the existing options.

PET PROGRAMS ON TAPE EXCHANGE

Gene Beals

Box 516
Montgomeryville, PA 18936

The "programs on tape" service and exchange functions as a low cost method for software distribution. The copying cost is \$1 per program. We can put up to 4 programs (8K) on a C-10 tape, or 12 on a C-30 tape. Please add \$1 per tape (either C-10 or C-30) to cover tape cost and postage within U.S. or Canada. If any written documentation is available, a copy will be included with the associated program.

If you have a program to contribute to the list (one which we don't have, or an updated or enhanced version of an existing program), please send it on tape. We will save it for the exchange and return a program of your choice.

We have also accumulated a number of four part harmony songs (for use with the various digital to analog boards). If you are interested in any of these, write for additional information.

Please write to me (Box 516, Montgomeryville, PA 18936) to request or exchange programs, or if you have any comments on the way the exchange is being conducted.

- SPACE RACE - Matt Ganis -- guide your spaceship to the top of the box through randomly moving stars.
- ACEY DEUCY - Matt Ganis -- you are dealt two cards and then bet whether your next card will be between the first two cards.
- BOMBER - Matt Ganis -- destroy the city by dropping bombs on it. Lose points for each bomb and accumulate points for each hit.
- MATH DRILL - William C. Anderson -- drill on addition, subtraction, multiplication, and division for numbers 1 through 12.
- OPTI-STICKS -- combines optical illusions and graphics demo of sticks rolling down hill - nice demo.
- TRACE-OLD ROM - Brett Butler -- self-relocating version
- TRACE-NEW ROM - Brett Butler -- self-relocating version
- LIFE 64*64 V.2 - Frank Covitz -- maintains symmetry through wrap around. Set for either growth or decay. Excellent machine language program.
- HORSERACE - Stephen Erlewine -- very nice version partly in machine language for the animation.
- MAZES - Stephen Erlewine -- creates single solution mazes of 3 different sizes for you to find your way through.
- MATH QUIZ - Stephen Erlewine -- drills for addition and subtraction using large numbers on screen.
- CRYPTOGRAMS - Stephen Erlewine -- create cryptograms. Solve ones you just created or one that you key in. Up to 5 lines long.
- TAG - Stephen Erlewine -- 2 player game of tag. You try to tag your opponent when you're "it".
- PIZZA - Stephen Erlewine -- primary grade educational game to help learn co-ordinates.
- PAR-SER - Vikash Verma -- package of 3 programs to simulate a parallel to serial interface and to produce hard-copy on RS-232 printer. Note: counts as 2 programs. Includes 3 pages of listing and instructions.
- KENO - Mel Fishman -- gambling number game.
- BIORYTHM - E. Wuchter -- select either screen display or line printer output.
- FLOPTRAN IV - Mark Zimmerman -- Floating Point Translator. Old ROM only.
- SPACE NIM - Matt Ganis -- very nice graphics used to depict droids zapping fuel barrels from the piles.
- STAR WARS THEME - J. Cannatta -- CB2 music.
- CONVERSION - Bob Freeman -- converts from most anything to anything else (metric-decimal, etc.).
- TYPING DRILL - Bob Freeman -- learn to use keyboard correctly.
- SHARK BAIT - JK Johnson -- hangman style program
- FLEA RACE - JK Johnson
- AWARI - Hans-J Koch -- German instructions - nice graphics CHASE with Sound
- STAR LANES - Gerald Hasty -- from Interface Age future-world business simulation
- KALEIDOSCOPE - Jerry Panofsky -- People's Computers
- HEXDEC - Wayne Reindollar -- converts and pokes values into memory for machine language programs
- 24 Second QUBIC - Mike Louder
- DOODLER - Jim Brannan -- draw type program
- GNIP GNOP - Jim Brannan -- 2 player ping pong
- PONG - People's Computers
- CURFIT - J. Butterfield -- fits data to 6 curves
- TRIANGLE - J. Butterfield -- solves any triangle
- METRIC - J. Butterfield -- does metric conversions
- DATES - J. Butterfield -- day of week, days between
- TRENDLINE - J. Butterfield -- fits, forecasts, graphs
- MILEAGE - J. Butterfield -- distances from Latitude/ Longitude
- FACTORS - J. Butterfield -- prime factors for any number
- MORTGAGE - J. Butterfield -- schedule of payments
- FINANCE - J. Butterfield -- present, future value etc.
- ADDER - Earl Wuchter - PET as printing adder (nicely done)
- BATTLESHIPS - J. Butterfield -- you vs. computer
- MOONLANDER - J. Butterfield -- graphics
- CRYPTO - J. Butterfield -- cryptogram solving aid
- JOTTO - J. Butterfield -- guess a word
- POEMS - J. Butterfield -- write poetry
- HIKONDIS - high monitor and disassembler from SPHINX. Modified by H. Chow. Old ROM
- ELIZA - adapted for PET by Dennis Cumberton -- the computer psychologist
- HAMMURABI - social simulation
- SLOT MACHINE - Michael Richter
- CRAPS - Michael Richter
- BREAKOUT - with Sound
- POP SHOT - from SPHINX -- shooting gallery with sound
- STARS - John Broomhall -- children's number guessing game
- LINEON - Frank Alexander -- solves linear equations using matrix invert subroutine.
- POUNCE - John Broomhall -- kids game. If you don't pounce the right number of spaces, the mouse might run into his hole.
- STAR WARS - John Broomhall
- AUTO-DOODLE - Frank Levinson -- draws very nice rectangular patterns

FOURIER - Frank Levinson -- very nice high density graphing - visual demo of Fourier approximation curve fit.

CRAPS2 - Earl Wuchter -- not a crap game; rolls dice & displays statistics on the rolls. Shows odds, displays dice.

SOLITAIRE POKER - D Howe -- submitted by E. Herstein - solitaire version of draw poker. Displays odds as you play.

PRO FOOTBALL - Modified by Carl Hennig from SRI Library

RENUMBER - Bill Seiler -- machine language version - old ROM

MATCH GAME - L Uher -- 23 matches

STAR TREK IV - Francis Chambers -- updated version with good graphics and more features

BRAIN STRAIN - Ed Herstein -- difficult puzzle with good graphics.

SNAKE - submitted by Ed Herstein -- a 0,1, or 2 player Trap game that speeds up the longer you go.

YAHTZEE - Pete Rowe submitted by Ed Herstein -- dice game

HANGMAN - Grant Paul -- has list of 500 words

HANGMAN 2 - for 2 players with PET keeping score - needs a little work on display & graphics.

COPY - R. Julin -- data file manipulation

TALK & TALKER - R. Julin -- Send ASCII characters between 2 PETs via parallel user port.

LEM - Horst Brinkler -- lunar lander includes attitude, angle, and orbit consideration as well as time, altitude, & velocity. English or metric measurements. No graphics.

INDEX - David Wilcox -- tape index to locate a specific program on a tape.

KENTUCKY DERBY - Tom Baker -- Horse race for any number of people with betting - good looking horses.

MAZE - Hans-J Koch -- Creates a single solution maze up to 19*10. Use cursor keys to find way through.

FLIGHT SIMULATOR - submitted by Jerry Panofsky -- instrument flying. Try to take off and land safely.

BACKGAMMOM - Bill Hood -- palys decent game.

PPONG - P. Rowe submitted by Ed Herstein -- similar to deflection with land mines

FN MACHINE - P. Rowe submitted by Ed Herstein -- feed numbers through machine, see output, deduce function.

WEIGH - Guess the lightest and heaviest object in 3 tries.

KLINGON CAPTURE - Mark Turner -- grid game from KILOBAUD

SIMON - Gary Mayhuk -- sound repetition game

OTHELLO/2 - F. Dunlap Modified by J Mendenhall

DIGIT SPAN - number recall in sequence and reverse sequence for progressively long numbers.

CENTRAL LIMIT - Dave Heise -- graphs results of repeated samples of any given size, showing averages tend to be normally distributed.

CHI SQUARE - Dave Heise -- constructs repeated random 4-fold tables and computes significance test for each. Nice graphic representation of statistical values. ©

Editor's Note:

Please address all PET Tape Exchange correspondence to Gene in Montgomeryville. If you're interested in a Tape Exchange for other machines, like Atari or OSI, write directly to me: Robert Lock, COMPUTE, Post Office Box 5119, Greensboro, NC 27403.

Some Exchange guidelines:

1. The Exchange is intended to promote the sharing of user generated software.
2. Be very careful that you submit only your own, original work to the exchange. Matters of copyright remain the sole responsibility of the individuals submitting the program. We accept no liability, express or implied. Do not submit modified (or unmodified) commercial software to the Exchange. It makes their job much harder. We make every effort to screen software; we will appreciate our readers' efforts to do the same.
3. We do not intend to promote the Exchange as a competitor to commercially available software. You'll find that commercial software is generally much more polished and documented than what you'll receive from us. ©

Software Company Formed

Thorwald Esbensen (author of A Micro for The Teacher in this issue) has announced the formation of a new company to market educational software. According to Esbensen, MICRO-ED programs will be available through Commodore Business Machines, Inc. as well as directly from MICRO-ED.

Esbensen, Coordinator of Elementary Curriculum and Instruction for the Edina, Minn. Public School System, quotes Len Lindsay in his promotional materials: "I have seen. . . programs by Mr. Esbensen, and he does a wonderful job of making them both instructional and interesting for children." Dealer inquiries are invited. ©

Memo to Machine Language Programmers

Jim Butterfield

Ways to find zero page space on new ROM:

If you are not using tape I/O, help yourself to locations \$B1 to \$C3;

If you are not using Basic (for the moment) you may swap out \$00 to \$8C and restore it before you return to Basic. Caution: calling add, multiply routines, etc., in fact calls Basic.

Do not touch \$8D to \$B0 and \$C4 to \$FA unless you lock out the interrupts totally - and this means no keyboard service, no clock update, no cursor flash.

Remember that the only things you really need in zero page are indirect pointers. Almost everything else can be moved elsewhere in memory with little speed penalty. Now that zero page working space is hard to get, use it sparingly. ©

PET' MACHINE LANGUAGE GUIDE



- Contents include sections on:
- Input and output routines.
 - Fixed point, floating point, and Ascii number conversion.
 - Clocks and timers.
 - Built-in arithmetic functions.
 - Programming hints and suggestions.
 - Many sample programs.

If you are interested in or are already into machine language programming on the PET, then this invaluable guide is for you. More than 30 of the PET's built-in routines are fully detailed so that the reader can immediately put them to good use.

Available for \$6.95 + .75 postage. Michigan residents please include 4% state sales tax. VISA and Mastercharge cards accepted - give card number and expiration date. Quantity discounts are available.

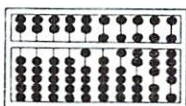

ABACUS SOFTWARE
 P. O. Box 7211
 Grand Rapids, Michigan 49510

IEEE-488 BUS SYSTEM BUILDING BLOCKS

For Commodore PET/CBM and other computers...

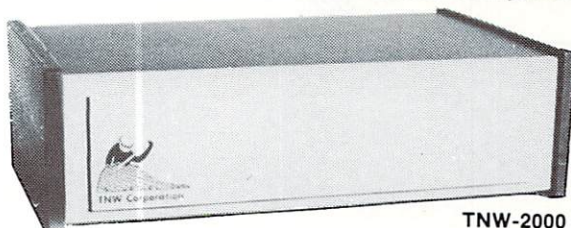

TNW-2000

TNW-1000 Serial Interface: \$129

1 channel output only

TNW-2000 Serial Interface: \$229

1 channel input and output

TNW-232D Dual Serial Interface: \$369

2 channels input and output plus RS-232 control lines

TNW-103 Telephone Modem: \$389

Auto answer/auto dial. Use with DAA

SOFTWARE **PTERM:** A program that turns your PET into a terminal (Use with TNW-2000, TNW-232D, or TNW 103)

SWAP: Allows storage of up to 8 programs in PET memory at once. Run them in any order.

PAN: A sophisticated electronic mail program (use with TNW-103)

PLUS Most popular computers, disks, printers, etc.

Write or call for information today:



TNW Corporation
 3351 Hancock Street
 San Diego CA 92110
(714) 225-1040

THE GREAT SUBSCRIPTION OFFER!

We're starting our "**COMPUTE Grows On!**" subscription drive, and want to be the fastest growing user resource in the industry.

Here's how you can help:

For every new subscriber you recruit, we'll match your effort with an extra issue added to your subscription. All your new subscriber friend has to do is include a line with their new subscription saying something like "I was recruited by ..." The "..." **has to include** your name and your zip code. Everytime we get a new recruit who refers to you, we'll extend your subscription by one issue.

COMPUTE grows, your subscription grows, and your new friend gets access to one of the best resources around. Copy this page or use the COMPUTE-Pons in the center of the magazine to let us know. The subscription extension offer ends June 1, 1980, so get busy.

Name _____ Company _____

Address _____

City, State, Zip _____

I was recruited By _____ My Computer Is: _____

THE SBC GAZETTE

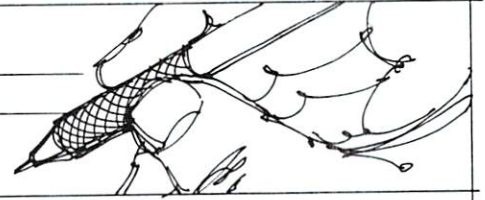

Mr. Robert Lock, Editor
COMPUTE

Dear Sir:

While browsing through the magazine rack of Minnesota Micro Systems in Minneapolis, I came across a new magazine, Compute. I thumbed through it and saw two articles on OSI computers. HURRAY. Someone knows that there are some OSI owners out here. That is more information in one month than other magazines have in a year.

As you might guess, I own an OSI computer. I am a newcomer to computing. I spent many hours researching the various microcomputers to enable me to make a somewhat intelligent decision if and when I bought a computer. There really isn't a whole lot of unbiased information available for the beginner. Much of the printed word is written for the experienced person and is not always understandable to those of us just learning the jargon.

Cost was the prime consideration. It is somewhat difficult to justify a purchase of over five hundred dollars for a hobby interest, especially a new hobby one knows next to nothing about.

I had decided to purchase an ATARI, having been very satisfied with their video game computer for three years. But no one had one for sale and could only say that they would be available shortly. APPLE was a bit expensive, PET didn't have color and had a strange keyboard. Radio Shacks sales people were not any more knowledgeable than I was so not much information was gained from them and I didn't consider their system.

While walking through a Montgomery Wards store in Minneapolis I saw a sign pointing to a "Computer Store". There was a small area with five or six OSI computers. I discovered that Wards was test marketing personal computers in two areas. OSI

in the Minneapolis-St. Paul area and another system in Houston, Texas. The salesmen were from the OSI factory. They were informative, answered questions, and demonstrated their equipment. It seemed that having the backing of Wards for a product might be somewhat more reliable than a computer store that had been in business for six months. So I purchased a Challenger 4P cassette input system.

I am pleased with my computer, but not so with the equipment documentation nor the support from the manufacturer. The operators manual is poor. It is written for a disc system. Only nine out of 238 pages deal with the cassette system. OSI downplays the cassette based system and suggests, "for a relatively small investment over the cost of a cassette system one can have the benefits of a mini-floppy disc system". That small investment happens to be a thousand dollars.

The manual is full of mistakes, mistakes even I have been able to identify. Capabilities such as the graphic, color, tone generator and DAC receive only passing mention, generally 1 small demonstration program, some of which contain errors and do not work. The manual is written on the assumption that all purchasers are knowledgeable and literate in computer terminology and technology. There is also a lack of software on cassettes that is listed in OSI's advertising material. I wrote to the factory for information about software and all I received was a copy of the advertisement I wrote about.

I guess it is the frustration of owning this marvelous machine and not having access to the information that is necessary to learn how to utilize it's capabilities. Your magazine is a ray of hope that help for me is on the way. I look forward to more OSI oriented articles in COMPUTE. I have been told by the salespersons at Wards that they have sold over fifty OSI systems since they began selling then in October. There are some interested persons in this area.

Thank you for a fine publication. I wish you much success for years to come. Remember, some of your readers are beginners. Define terminology, identify what system a program listing is for.

Herbert Crandall
3135 East 69th Street
Inver Grove Heights, Mn. 55075

Thanks for a good letter. All of you potential authors out there should note the last two sentences. We've tried to help with the expanded table of contents, new this issue.

Robert Lock

The Single-Board 6502

Eric Rehnke

Even though February in California is like spring and summer in most other places, I've still been able to get some useful things accomplished.

On March 14 through the 16th, I'll be in San Francisco for the West Coast Computer Faire (my first one!). Depending on the timing, I may have a report for my next column.

By the way, even though I don't publish the 6502 User Notes anymore, I still like to get letters, comments about my column, product announcements etc. These can be sent to me directly at 540-61 South Ranch View Cir, Anaheim CA 92807. Articles and programs for submission to COMPUTE should, of course, be sent to the magazine.

TINY C FOR THE 6502

After following up on an ad in one of the computer classifieds, I discovered that a TINY C interpreter was indeed available for the 6502. I even placed an order so there may be a product review coming up in the near future. A friend of mine with an 8080 system purchased TINY C so I got a chance to see what the documentation was like. It was excellent. Looked like an ideal system for the neophyte to learn programming. (Yes, I'm aware of BASIC, but since BASIC is not structured it's easy to get sloppy and become an on-the-fly programmer. I feel that people who intend to get serious about learning how to program should first learn some sort of structured language such as ALGOL, C or perhaps PASCAL before moving over to BASIC).

Oh yes, the source listing and a KIM cassette are available.

For more info, contact:

TINY C ASSOCIATES
PO Box 269
Holmdel, NJ 07733
(201) 671-2296

1 K ADVENTURE GAME FOR KIM

Will wonders never cease?

I've just been playing around with a new KIM game from Robert Leedom (he also wrote HEX-PAWN and BASEBALL). KIM ADVENTURE plays a surprisingly good game for its size (I haven't even been able to finish a game yet with any treasures).

There are 24 locations, a dragon, some wizardry, a magic wand, etc. and so on. ALL IN 1K OF RAM!!!

The game can literally span several sessions of one to two hours apiece before you become an experienced traveller. There are eleven skill classifications from unrated to Grandmaster.

All in all, a very exciting game concept for a basic KIM. Could keep you (or your kids) busy (enchanted) for hours!

For more info, contact:

Bob Leedom
14069 Stevens Valley Ct.
Glenwood, MD 21733

AIM 65 TEST PROGRAM AVAILABLE

Some of you AIM users will be happy to hear that Rockwell is making available the program that they use to check out AIM's before they are shipped.

The program is 5K bytes long and normally resides in a couple of EPROMS which gets installed in the BASIC ROM slots.

If you're interested, order the Test Manual (EA74-M800) and the Test Program listing (PL-EA74-J100) at \$15.00 for the pair from:

Rockwell International
Spares Control
PO Box 3669, RC-48
Anaheim, CA 92803

OSI MONITOR LISTING NEEDED

A friend of mine has an OSI C2-4P computer. Now he's been pretty happy with the machine despite the rather meager documentation - but he needs to know more about the machine than OSI wants to divulge. He needs a listing of the monitor so he can use the built-in I/O devices in his own programs. (Actually, he wants to use his C2-4P as a serial terminal for his KIM-1. BRAVO!!!)

The fact that OSI (and one or two others) don't document the monitor routines for the user completely baffles me. Do they think that some other company will copy their code or do they not consider this a part of properly documenting their machines? Since nobody I'm aware of has "ripped-off" the Apple or KIM monitor programs, I'm sure this can't be the problem.

Does anyone know why OSI doesn't choose to document their hobbyist systems to the same degree as the Apple, KIM SYM, or AIM?

In the meantime, if any of you OSI freaks has generated a source listing of his 65V monitor PROM (as found in the early C2-4P) could you please help a fellow user in distress?

Send it to: Ron Regal W8GMH
5614 Alber Ave.
Parma, OH 44129

VAK-7 FLOPPY

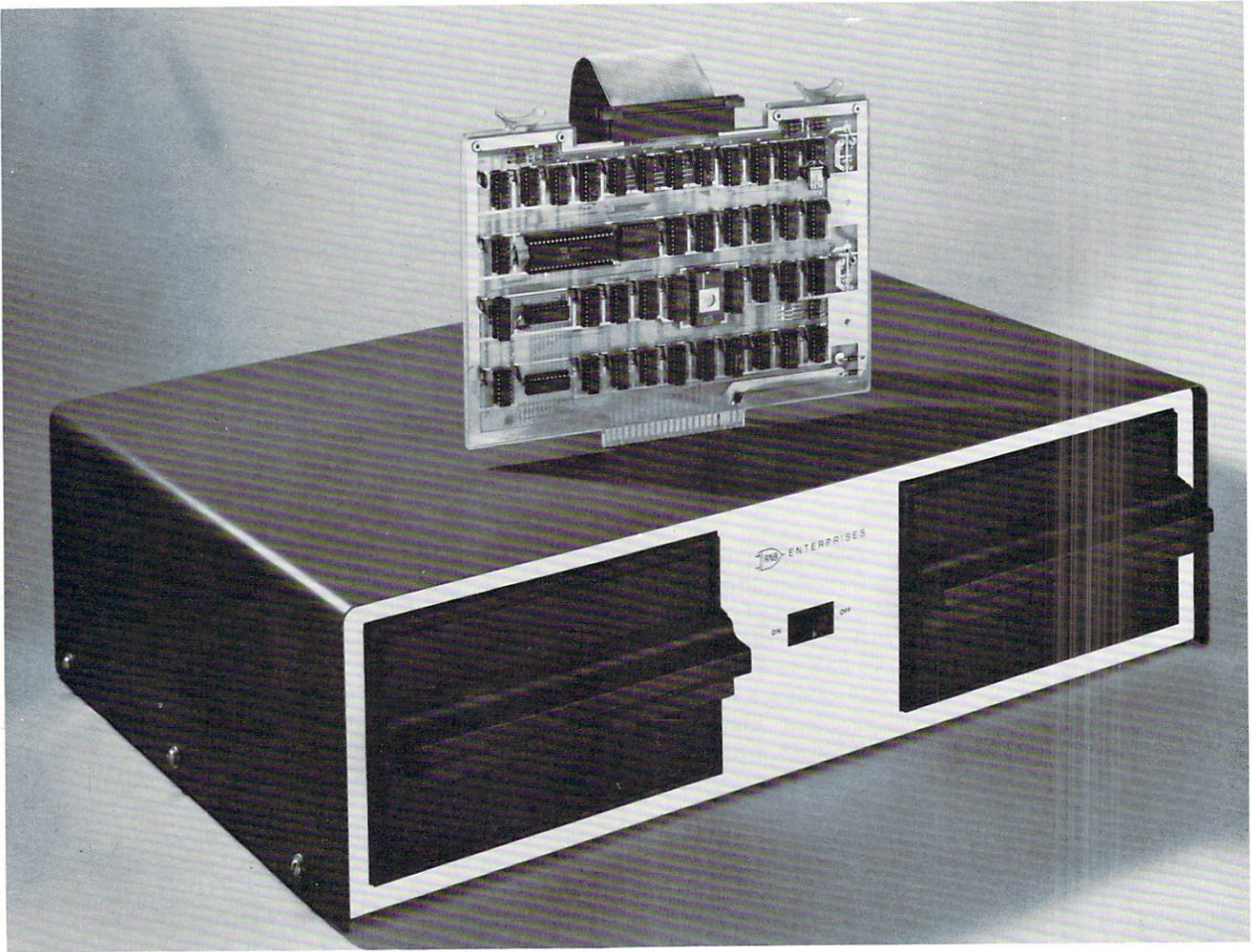

The VAK-7 Disk System was specifically designed for use with AIM-65, SYM-1, and KIM-1 Microcomputer Systems. The VAK-7 will plug directly into the VAK-1 Motherboard or with the addition of regulators into the KIM-4* Motherboard. The VAK-7 is a complete full size (8") FLOPPY DISK SYSTEM. This system will READ, WRITE, and FORMAT both IBM SINGLE and DUAL DENSITY diskettes. Single-Sided is standard and Dual-Sided is optional. Our Single-Sided drives are set up so they can be converted at a later date to Dual-Sided by the factory, if your storage needs increase.

The VAK-7 system occupies a 4K address space. The system has a 1K block of D.M.A. RAM as a transfer buffer. Also, a 1K block of RAM reserved for D.O.S. pointers, drive status, and catalog information. The remainder of the address is occupied by the resident 2K MINI-DOS. This MINI-DOS is a complete set of subroutines to Read, Write, and Format.

DISK SYSTEM

The MINI-DOS is not a high level Disk Operating System, but contains all the elementary subroutines for implementation of a high level DOS. Since all the functions are in subroutines, the implementation of this system into a dedicated system is simplified.

MINI-DOS SUBROUTINES

Block Move	Read/Write Deleted Data
Seek Track	Format Disk/Test For Bad Sectors
Recalibrate Disk	Initialize Disk
Sense Interrupt Status	Physical Copy (Disk to Disk)
Read/Write Data	Self Test

The VAK-7 is an interrupt driven system, which uses the \overline{IRQ} vector. Since this is an interrupt driven system, your system processor is only used to move data into or out of the 1K of DMA RAM, issue the command, and check status at the end of the disk operation. Your system processor is free to do other functions, during disk operations because the intelligent disk controller will complete the operation without tying up valuable processor time.

The VAK-7 System comes complete with Disk Controller Board, Interconnecting Cable, a Cabinet with Power Supply (for two Disk Drives) and one Disk Drive. The VAK-7 Controller can handle up to Four Drives.

SPECIFICATIONS:

- Completely assembled, tested, and burned in.
- Occupies address \$9000-\$9FFF for AIM-65, \$9000-\$9FFF for SYM-1, or \$E000-\$EFFF for KIM-1.
- IBM Format; Single Density (128 bytes/sector); Dual Density (256, 512, or 1024 bytes/sector).
- All IC's are in sockets.
- Fully buffered address and data bus.
- Standard KIM-4* BUS (both electrical pin-out and card size).
- Designed for use with a regulated power supply, but has provisions for adding regulators for use with an unregulated power supply.
- Dimensions: Board—10" wide x 7" high (including card-edge)
Cabinet—23.5" wide x 6.5" high x 16" deep.
- Power Requirements: +5V DC @ 2 Amps.
117V AC 60Hz @ 2 Amps.

*KIM-4 is a product of MOS Technology/C.B.M.

PRICE:

Single-drive, 1-sided	\$1,299.00
Dual-drive, 1-sided	1,898.00
Single-drive, 2-sided	1,499.00
Dual-drive, 2-sided	2,398.00

	<u>Plus Shipping</u>	<u>UPS</u>	<u>Mail (APO, FPO)</u>	<u>International</u>
Single Drive	12.00	32.00	32.00	Shipped Air Freight. Freight charges collect.
Dual Drive	16.00	44.00	44.00	

For Alaska and Hawaii, use mail rates.

We manufacture a complete line of high quality expansion boards. Use reader service card to be added to our mailing list, or U.S. residents send \$1.00 (International send \$3.00 U.S.) for airmail delivery of our complete catalog.



2967 W. Fairmount Avenue
Phoenix AZ 85017
(602)265-7564



If you send me a copy, there's a good chance we could print it here in COMPUTE and assist other information hungry OSI users.

INDEPENDENT OSI USERS NEWSLETTER

I just received the first issue of a newsletter intended for OSI users. The publisher, Charles Curley, wrote all of the 8 page issue himself with the help of his C2-8P disk system.

Included in issue #1 were fixes for bugs in two of the OSI operating systems, a book review, a hardware review, information on an accessible time sharing system, and an interview with Alan Taylor who is the head of OSI's west coast office.

Looks like it could be useful if enough users contribute information. Subscription rate is \$10 for six issues.

contact:

Charles Curley
6061 Lime Ave #2
Long Beach, CA 90805

SYSTEM SOON FROM HDE

Hudson Digital Electronics (POB 120, Allamuchy NJ 07820) will soon be announcing their first packaged system-the OMNI 65.

Based on KIM as the CPU, OMNI 65 will consist of two mini floppy drives, 32K of RAM, EPROM boot for the disk system and system software dependent on which version of OMNI 65 is ordered. Three versions will be available: the engineering version, the word processing version and the full development version. Full size disk drives will be optional.

Basic price for the system will be from \$4000 to \$4500 depending upon the configuration.

MAKING BEAUTIFUL MUSIC

I've been mildly interested in computer music generation (synthesis?) for some time now. But it wasn't until Texas Instruments introduced their SN76477 Complex Sound Generator that I saw a real possibility for turning my computer into a real-time music generator (as opposed to the more usual method of first composing a song and entering it into the system for later play).

A study of the SN76477 chip, however, indicated that full digital control over the sound output wouldn't be a straight-forward task. A number of external resistors and capacitors are needed to set the sound parameters and it just ain't that easy to control these analog critters without getting into complex read relay or electronic switching.

So, the idea for a real time musical instrument was shelved for awhile until a more suitable method of digitally controlled music output.

Fortunately, I didn't have to wait too long to find a suitable candidate for my "instrument".

It came in the form of an article published in the July 79 issue of BYTE magazine. The article was written by Stephen Ciarcia and discussed the operation of the TI chip AND a new device on the market- the General Instruments AY3-8910. The GI chip has the same sound generating abilities as the older TI device but offers complete digital control over all the sound parameters. A significant advantage and a necessity for my particular application.

Basically, there are two ways of generating computer music. The first method is to have the computer do all the sound generation. This can range from the simple "kluge" harp which consists of a simple transistor "amplifier" hung on one bit of an output port to a more complex device such as the popular Micro Technology Unlimited K-1002 DAC music board and associated 4-port music software. (I feel that the MTU DAC board represents the pinnacle of achievement in computer generated music).

The second method is to use the computer as the controller of a sound generating device such as a top octave generator, a full synthesizer, or, as in this example, the GI AY-3-8910 Programmable Sound Generator chip.

The main advantage to using the computer as a control element in a sound generating system and not as the sound generating device itself is that a lot of CPU time is freed up for other tasks such as handling the instrument keyboard interface and perhaps controlling a number of sound generating subsystems. The use of hardware subsystems could also simplify the system software generating task.

The AY-3-8910 has three audio output channels, each channel having its own tone generator, noise generator, a mixer to combine the outputs of the tone generator and noise generator, amplitude control with fixed or variable amplitude pattern, an envelope generator to control the variable amplitude pattern and a D/A converter that produces up to a 16 level output signal as determined by the amplitude control.

Pretty slick!

Since each chip has three separate audio outputs and I will be controlling the system with a three to six octave surplus electronic organ keyboard, it would be nice to have one audio channel for each of my ten fingers (assuming I could, or would, span 10 different keys at the same moment). That says we need at least 4 sound generator chips to handle the task. Well, it just so happens that 4 devices can be hooked to a 6522, or any of the PIA devices, rather easily since the 8 bit data port on the AY-3-8910

HDE inc.

BOX 120
ALLAMUCHY, N.J. 07820
201-362-6574

HUDSON DIGITAL ELECTRONICS INC.

THE HDE CARD CAGE

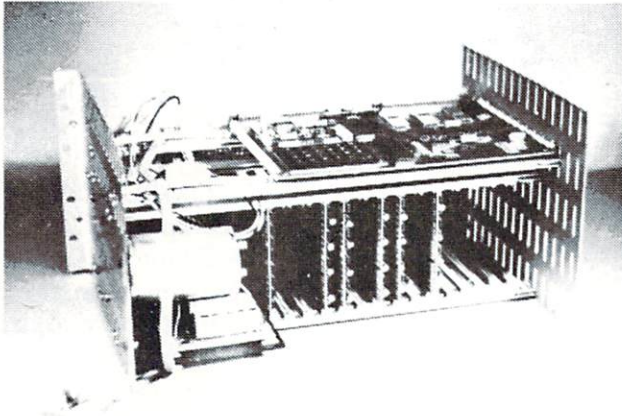

Shown With KIM-1 (not included)

Now you can expand your 65XX single board micro-computer into a powerful microprocessor based system with the 19" (RETMA standard) HDE DM816-CC15 Card Cage. The DM816-CC15 has virtually all of the features you need for even the most demanding situations. Complete with power supply, backplane, card guides and supports, the HDE DM816-CC15 accepts state of the art 4½" wide cards permitting your system to remain a compact configuration, while expanding with a variety of functions.

HDE has developed the DM816-CC15 for the demanding industrial marketplace. Consequently, you can design your KIM*, AIM* or SYM* based installation using RETMA standard cabinet or rack components. Sufficient clearance has been included for custom front panel switches, lights and controls as well as cable and fan installation at the rear. The microcomputer is mounted to permit convection cooling in all but the most densely packed situations.

The self-contained power supply is rated +8 VDC at 12 A and ±16 VDC at 3 A (both unreg.). The backplane, with the standard S44 bus, accepts up to 15 cards and has on board 5 VDC and 12 VDC regulators. In addition to power on reset, the backplane in-

VERSIONS

KIM*	AVAILABLE
AIM*	1st Qtr. 80
SYM*	1st Qtr. 80

\$525.00

Complete With Power Supply

cludes the logic connectors for remote reset, stop and single step as well as cassette and 20 mA loop terminal I/O. Provisions for data and address bus termination are included. Two 16 pin DIP pads are available for unique requirements and the micro-computer application and expansion connectors are extended to the backplane further increasing the utility of the total package.

Other HDE products include:

- 5¼" and 8" single/dual disk systems
- 8K static RAM memory
- Prototyping cards
- Software (disk and cassette)
 - Text Editor (TED)
 - Text Output Processing System (TOPS)
 - Assembler (ASM)
 - Comprehensive Memory Test (CMT)
 - Dynamic Debugging Tool (DDT)

Watch for announcements:
EPROM Card, RS232 Card, PIA Card, DAC Card

- * KIM Is a Commodore product
- * AIM is a Rockwell International product
- * SYM is a Synertec product

HDE PRODUCTS - BUILT TO BE USED WITH CONFIDENCE

AVAILABLE DIRECT OR FROM THESE FINE DEALERS:

JOHNSON COMPUTER
Box 523
Medina, Ohio 44256
216-725-4560

ARESCO
P.O. Box 43
Audubon, Pa. 19407
215-631-9052

PLAINSMAN MICROSYSTEMS
Box 1712
Auburn, Ala. 36830
800-633-8724

LONE STAR ELECTRONICS
Box 488
Manchaca, Texas 78652
612-282-3570

PERRY PERIPHERALS
P.O. Box 924
Miller Place, N.Y. 11764
516-744-6462

tri-states when unselected so can be paralleled together and each chip has 2 control lines. The interface will look something like this:

AY-3-8910

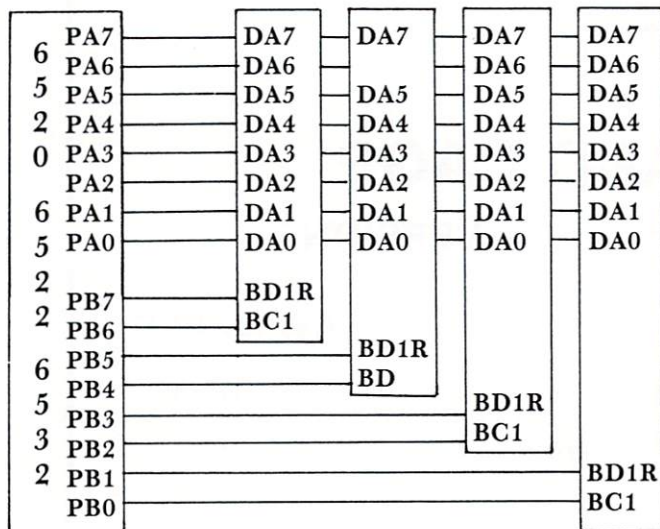

PRODUCT REVIEW

I've been using the MICRO TECHNOLOGY UNLIMITED K1000-5 power supply with my AIM 65 for several months now. The supply is fully enclosed with the 5 volt regulator and a large heat sink mounted on the outside of the box.

With a fully loaded AIM (4K RAM, Assembler and Basic ROMS) and an HDE 8K RAM card connected to the AIM expansion connector, the 5 volt regulator on the MTU supply got just a bit too warm to touch for more than a fraction of a second. Without the external 8K RAM board, the regulator barely got even warm.

This indicated to me that there was some reserve capacity built into the design of the supply. MTU has a very good reputation for having their engineering act together and I haven't found any reason to doubt this from what I've seen.

The one problem that I did have with the unit was a failure of the 5 volt regulator. Now this happened shortly after I soldered a LED across the output of the regulator so I could have inadvertently applied too much heat to the device. I'm not sure. However, MTU cheerfully repaired the unit and I haven't had any trouble since. (I even ran the heavy load experiment several more times to be sure).

The only thing I didn't like was the lack of a power switch and pilot light. I installed these at a cost of \$1.50. When I mentioned this to MTU they indicated that they would consider adding these items to future units.

I liked the fact that the K1000-5 was fully enclosed and ready to use as opposed to some of the open-

frame supplies available which need to have a power cord and fuse hooked-up and which are also unsafe because of exposed AC voltages.

The MTU supply retails for \$80.00 and more information can be obtained from MTU, P.O. Box 4596, Manchester, NH 03103.

©

More about compute II

Robert Lock

This is your last issue of COMPUTE; next month you'll receive Issue #1 of **compute II**. The problem, as explained briefly in the Editor's Notes, is one of wanting COMPUTE to grow in too many directions at once. It's frustrating to me to have to limit the SBC Gazette to a handful of articles when you're sending them in as fast as the rest of the magazine readers put together.

Our solution? Your "own" 56 - 64 page magazine. **compute II** will maintain all of the quality and enthusiasm of COMPUTE. I hope many of you will choose to subscribe to both, but regardless, let's get to work making **compute II** as healthy a resource magazine as COMPUTE has become. Please send me your comments, programming hints, articles and suggestions. One last note: we are currently redoing most of the artwork submitted with articles and columns. In many cases we are unable to redo some of the listings. Rather than use five or six pages of needed space for program listings, we're reducing them. A good example is Eric's Pet to Aim program listing in this issue. I would appreciate your comments on the readability. Materials should be sent to my attention, **compute II** magazine, P.O. Box 5119, Greensboro, N.C. 27403.

Nuts and Volts

Gene Zumchak

With this article, I hope to begin a series of dissertations on the art and joy of doing it yourself. But first let me introduce myself. I'm Gene Zumchak. I graduated with an M.E.E. from Cornell in 1968. I paddled across Cayuga Lake and got my first job with a likable maverick named Robert Moog of Moog Synthesizer fame. I left my first, and one of the only legitimate jobs I've had in 1970. I moved to Buffalo and since that time have worked for a series of little flake outfits trying to find a winner, but at the same time, avoid having to work for a living. So far I've managed neither, but sure have had a lot of fun. But alas I think I'm getting closer. I now call myself Niagara Micro Design, Inc., and although the pay isn't that hot, the boss let's me play golf whenever the whim takes me (between thaws in July).

Anyway, I started drooling over micros in the early seventies when they first appeared in the electronic design magazines. Then in '75 an unknown semi company called MOS Technology made a big two month splash in the magazines (never to be heard from again) prior to a Western show. I clipped a coupon, sent in \$25 and became the proud owner of a 40-legged centipede called a 6502. Now to give you some idea of just how fantastic that was, the 8080 chip set (8080, 8224, 8228) was selling for over \$200. A few days after the chip arrived, I got a flyer advertising a single-board computer for just a few bucks more than the naked 8080 chip set. I ran to the bank, withdrew my life savings and sent in coupon number two becoming an even prouder owner of KIM-1 serial no. 00005. Soon afterwards, three friends and myself contracted to design and build five smart printer systems for Honeywell, without a TTY or assembler, let alone a development system. With little more than that KIM and a Simpson VOM we delivered five microprocessor controlled printers. Today, the same job would be a lot easier, but my "development system" is still just an expanded KIM. Anyone, in fact, can put together a development system for only a couple hundred dollars over the price of a KIM, SYM, AIM or other system. Putting together that development system is one of the topics I hope to get to in the future.

Presently I am working on a book entitled "Microcomputer Design and Maintenance" with the guidance of Jon Titus of the "Blacksburg Group" who hopefully will get it published. The topics presented in this series of articles in Compute will touch on some of the material in that book, as well as different material.

A dedicated micro system can be put together for under a \$100. Why tie up your Apple or Pet to turn the furnace on, run your electric train, or program your wife's loom? Why not use your system as a tool to crank out dedicated controllers? I hope to show you how. Enough B.S. Let's start talking about hardware.

Read/Write Timing

The most important consideration in hardware design is read/write timing. It is not a complicated topic, but many "designers" avoid confronting it by surrounding a CPU with family chips (usually expensive) using circuits right out of the manuals. There's nothing wrong with the fancy family chips if you really need them. Oftentimes the most attractive chip may belong to another family. If you understand read/write timing, however, you may indeed be able to use a foreign chip.

Write Timing

The terms "reading" and "writing" always reflect the direction of data flow from the perspective of the processor. Thus in a "write" operation, data is presented by the processor to some external device, memory or output, and locked into that device. A bit of memory or output is a flip-flop. In memory, the output of the flip-flop can be read back into the processor. In "output", the output of the flip-flop is connected to the world. (In some programmable devices, an output can often be read back into the processor.)

The usual type of flip-flop used with a processor is the "D type" flip-flop. A D flip-flop has a "D" or data input, and a clock (strobe) input which is an edge-sensitive function. That is, data is presented to the D input and is transferred to the output when the active edge occurs (usually positive going). An edge triggered flip-flop's output can change only on a clock edge. An example is the TTL 7474 dual D flip-flop. A variation of this is the transparent latch. It too has a D or data input, but a Gate input, instead of a strobe. When the gate is true, the output follows the data and is transparent to the data. Data is locked into the flip-flop on a false going gate edge. The 7475 is a quad transparent latch. In both types of flip-flops, data is locked in with a clock or gate edge.

In any latching operation, the following sequence occurs: Data is presented to an input, a locking edge occurs, and finally the data is removed. In general, the data to be written exists before and after the locking edge. We are now ready to define the important parameters of a write operation. The "set-up" time is the minimum time the data must be present before the locking clock edge occurs. The "hold" time is how long the data must remain after the locking edge has gone away. The set-up and hold times for a 7474 flip-flop are only 20 and 5 ns.

FACTORY PRICING

IN STOCK!

IMMEDIATE DELIVERY!

ALL MOS TECHNOLOGY MPS 6500 ARRAYS---

PLUS

- MPS 6550 RAM for PET
- MPS 6530-002, -003 for KIM-1
- MANUALS
- KIM-1 MICROCOMPUTER
- KIM-3 8K STATIC RAM MEMORY BOARD
- KIM-4 MOTHERBOARD
- KIM PROMMER
KIM-1 & 4 Compatible Eprom Programmer
- KIMATH
Chips with Listing
- KIMEX-1 EXPANSION BOARD
KIM-1 Pluggable PROM, Ram and I/O Board
- RS-232 ADAPTER
For KIM-1
- POWER SUPPLIES

STANDARD MICROSYSTEMS

- ★UART's
- ★FLOPPY DISC DATA HANDLER
- ★BAUD RATE GENERATORS
- ★CRT CONTROLLERS

FALK-BAKER ASSOCIATES

382 FRANKLIN AVE ● NUTLEY, NEW JERSEY 07110
(201) 661-2430

WRITE, CALL, OR RETURN OUR COUPON FOR CATALOGUE AND PRICE LISTS.

respectively. Since these times are so short, TTL latches can always be assured of working with MOS processors.

6502 Write Timing

A 6502 clock cycle is read cycle when the R/W line is high, and a write cycle when the R/W line is low. A cycle is divided into two (more or less) symmetrical halves. In the first half, the 01 clock is high. The R/W line and the address lines change 01. In 02, data transfers occur. According to the spec sheet, the delay from the fall of 02 to the beginning of the rise of 01 can be zero (no max spec given). For zero delay, the 01 clock is approximately 02. However for external use, 02 and 02 are generally used. 01 should not be used as a substitute for 02. Figure 1. shows write timing for the 6502.

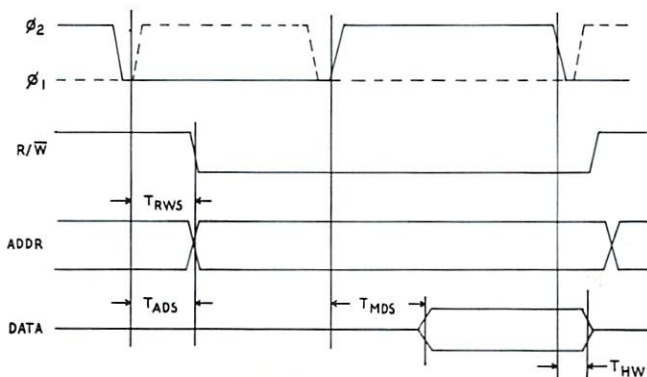

Figure 1. 6502 Write Timing

The R/W and address lines have a setup time (T_{RWS} and T_{ADS}) as 300 ns. maximum after the beginning of 01. Data is available in a maximum of 200 ns. after the rise of 02 (T_{MDS}). 02 has a minimum width of 430 ns with a one micro second clock (1MHz). Thus data is available a minimum of 230 ns. before the fall (locking edge) of the 02 clock. The data is held beyond the fall of 02 for a minimum of 30 ns. (T_{HW}). Thus the 6502 is guaranteed to write successfully to any device with a set-up time requirement of 230 ns. or less, and a hold time requirement of 30ns. or less. Implicit in the timing is that the falling edge of 02 is the locking edge. The 6502 generates no write strobe. A write strobe must be fabricated by NANDing 02 with the inverted R/W signal, R/W. This gives a strobe that goes low during 02 only for a write cycle. In family devices, 02 and R/W are applied separately and the gating is performed internally.

6502 Read Timing

In a read operation, an external device puts its data on the data lines and it is locked internally

into the 6502 at the end of 02. This timing is shown in figure 2.

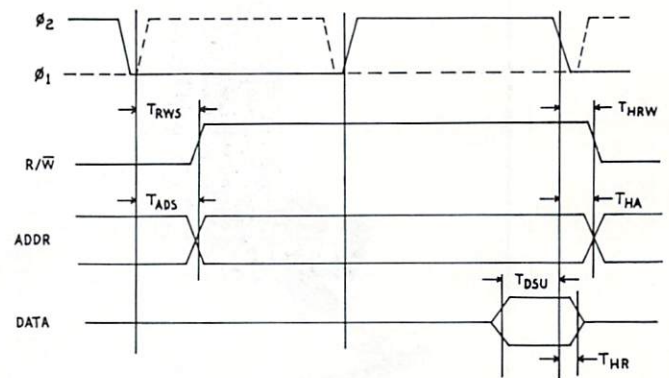

Figure 2. 6502 Read Timing

As in a write cycle, the address and R/W set-up time is a maximum of 300 ns. into 01. The data set-up time is a minimum 100 ns. before 02 (T_{DSU}). In addition, the data must be held a minimum of 10 ns. past 02. Both the set-up and hold times for the 6502 in a read operation are quite short making it easy to read I/O devices from any MOS family.

When a device is read, the data is gated onto the bus by a read gate generated from the R/W line and a decoded address. The strobing is done internally by the processor. A gating signal allows the data to overlap the strobe. It will be seen in many 6502 systems that read gates often incorporate 02. It would appear that this would cut off the data at strobe time, and violate the hold time requirement. First of all, the tri-state gate buffering the data probably has a delay of at least 15 ns. Secondly, if 02 has gone through one or two gates of buffering, it will occur 15 to 30 ns. after the 02 seen at the 6502. Thus the data will remain on the data bus 30 to 45 ns after 02, even though 02 appears to be used to cut data off. ©

Gene's column will be continued in Issue #1 of compute II with a discussion on interfacing non-family devices. RCL

Introducing SEAWELL's

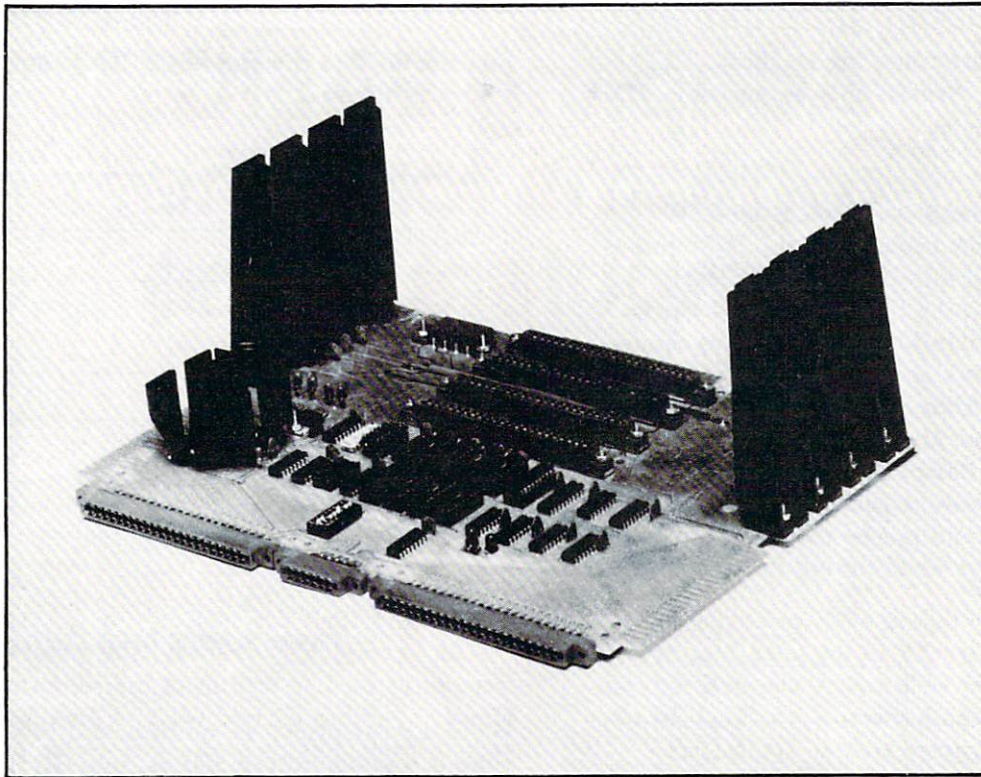

Little Buffered Mother

The ultimate Motherboard for any KIM-1, SYM-1, or AIM-65 system

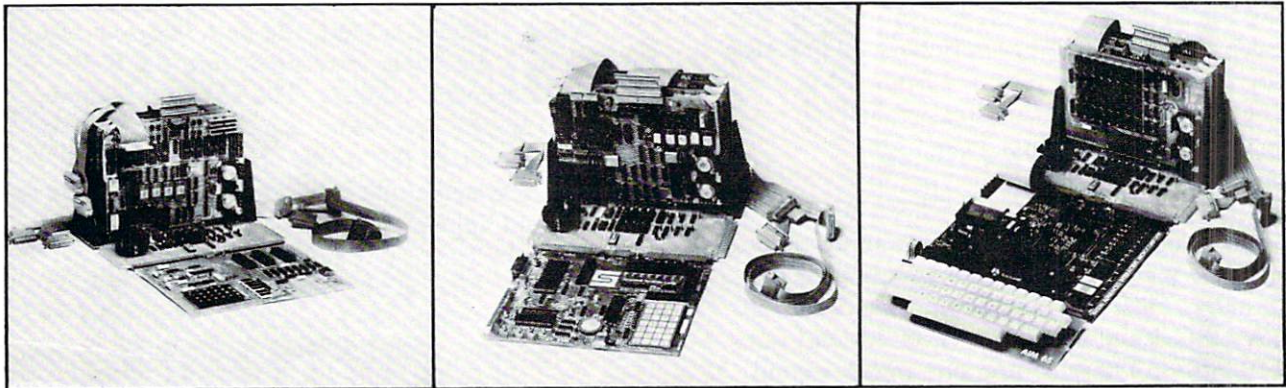

Features:

- 4K Static RAM on board
- +5V, +12V, and -12V regulators on board
- 4 + 1 buffered expansion slots
- Accepts KIM-4 compatible boards
- Full access to application & expansion connector
- LED indicators for IRQ, NMI, and power-on
- Also compatible with SEA-1, SEA-16, the PROMMER, SEA-PROTO, SEA-ISDC, and more
- Onboard hardware for optional use of (128K addressing limit)
- Mounts like KIM-4 or with CPU board standing up
- 10 slot Motherboard expansion available - SEAWELL's Maxi Mother

\$199.00

Assembled Only

For further information contact:

SEAWELL Marketing Inc.
P.O. Box 30505
Seattle, WA 98103

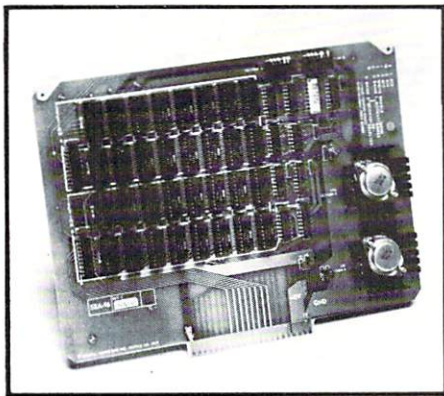

SEA-16/16

SEA-16/16 is a 16K x 8 Static RAM Board. Two individually addressable 8K blocks of RAM, with individual WRITE PROTECT and optional Bank Switching. SEA-16/8 is the same as above except 8K of RAM not installed.

SEA-16/BLANK is the same as above, except no RAM is installed, thirty two 2114's makes it go.

SEA-16/16-45 \$325.00

Little Buffered Mother's Compatible Hardware

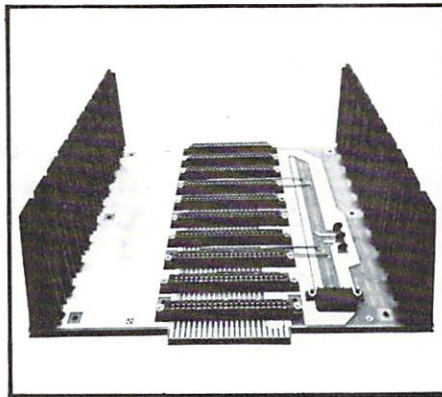

The Maxi-Mother

The Maxi-Mother® is a 10 slot Mother Board. Combined with the Little Buffered Mother®, it provides 14 slots or use it stand-alone with SEA-1.

MAXI-MOTHER \$135.00

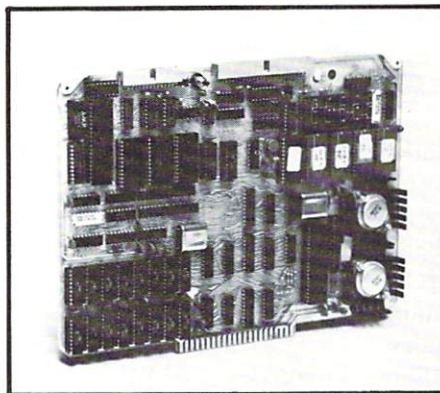

SEA-1 Seawell's CPU Board

MCS 6512 CPU, 3 Hardware RS-232 Ports, one current-loop, programmable Audio Tape interface, 9K + Static RAM, up to 18K of ROM/EpROM, Single Step Hardware, Bank Switching, Interrupt driven Monitor, and more.

SEA-1, 1.5 MHz \$595.00

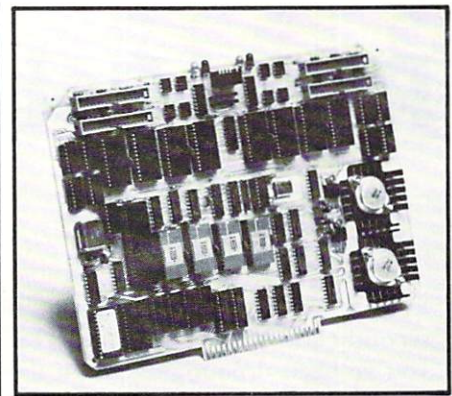

SEA-ISDC Intelligent Serial Data Concentrator

MCS 6512 CPU, 4K of Dual Port RAM, 2K local RAM, 4K EpROM/ROM, 8 RS-232 Ports. The SEA-ISDC can operate as a stand-alone computer or as a buss compatible "Front End" I/O Processor for a larger system. The 4K of RAM can be accessed by either CPU without delay.

SEA-ISDC \$595.00

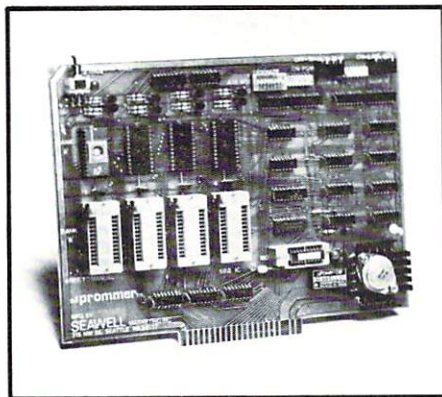

The Prommer

EpROM Programmer and EpROM/ROM Board. Memory mapped EpROM programming will program up to 16K per command, firmware in PROM included. Specify KIM, SYM or AIM.

(Presently in redesign. Available soon.)

All products are assembled. No kits.



Or go for the works!

AIM-65 with the Little Buffered Mother®, the Maxi-Mother® and SEA-16/16.

Available Soon!

Development System
Parallel I/O Board, Prototype Board and Floppy Disk Controller
CMOS/PROM/Real Time Clock Board

SEAWELL Marketing Inc.
315 N.W. 85th
Seattle, WA 98117
(206) 782-9480

Read Pet Tapes With Your Aim

Eric Rehnke
Mark Reardon

From now on, you AIM owners needn't feel like second class citizens. All those PET Basic tapes that you've been drooling over can now be fed into your AIM. Admittedly, you'll have to force feed them since AIM doesn't normally read PET cassette tapes, but, it's almost painless and just think of all the fun you'll have.

What this program that Mark and I have written **DOES do** is read a PET Basic program into memory and convert all the convertible token to those used by AIM Basic. There are, however, a number of PET tokens which cannot be converted to AIM and these special tokens are printed out together with the line number they are found on. The conversion program then replaces these offending tokens with a REM token so they can be easily found. The BASIC program can now be saved to AIM cassette using the normal Basic SAVE command.

What this program **DOES NOT do** is get the PET program to actually RUN on AIM. You'll have to change any PEEKS and POKES or use of Pet's graphics to look at AIM's memory locations and use AIM I/O devices.

Programs that use very little of PET's graphics or special memory locations will, of course, be the easiest to convert.

Since most PET programs are written for 8K systems, there should be at least 8K of RAM in your AIM. Also, you'll need to connect up the remote control to your cassette deck for reading PET tapes.

First, turn the printer on, then load the PET loader into your system and start it running at \$0200 (or use the F1 key if its properly initialized). Now start reading a PET cassette. When the loader finds a program on the tape it will stop the recorder and prompt with the program name and the last address that it will occupy in memory.

Press 'Y' to load that program. When it's loaded, the conversion program will go through each program line printing out the line number and converting all the tokens in that line. If the printer was turned on, you'll now have a listing of the line numbers. Any tokens not found in AIM will be printed out and then replaced with the REM token so AIM BASIC doesn't choke.

When all the lines have been converted, the PET Loader will automatically initialize and jump into BASIC. The PET program can now be listed and saved in the normal fashion.

If any other key besides "Y" was pressed in response to the program name prompt, the program will skip forward to find the next program on the tape. Since the PET Loader does not mess around with anything contained within quotes and PET programs can have special cursor controls enclosed within quotes, funny things will get printed by AIM in place of the cursor controls. AIM Basic will interpret these cursor control characters as tokens and print out the equivalent AIM BASIC statement.

The cassette read portion of this program is a much modified version of a program originally published in MICRO magazine, page 61 of the June 1979 issue and written by Dave Kemp.

128	END	164	+
129	FOR	165	-
130	NEXT	166	*
131	DATA	167	/
132	INPUT	168	^
133	DIM	169	AND
134	READ	170	OR
135	LET	171	>
136	GOTO	172	=
137	RUN	173	<
138	IF	174	SGN
139	RESTORE	175	INT
140	GOSUB	176	ABS
141	RETURN	177	USR
142	REM	178	FRE
143	STOP	179	POS
144	ON	180	SQR
145	NULL	181	RND
146	WAIT	182	LOG
147	LOAD	183	EXP
148	SAVE	184	COS
149	DEF	185	SIN
150	POKE	186	TAN
151	PRINT	187	ATN
152	CONT	188	PEEK
153	LIST	189	LEN
154	CLEAR	190	STR\$
155	GET	191	VAL
156	NEW	192	ASC
157	TAB (193	CHR\$
158	TO	194	LEFT\$
159	FN	195	RIGHT\$
160	SPC (196	MID\$
161	THEN		
162	NOT		
163	STEP		

Aim Tokens

Program Listing

```

0002 1000=      RAMTOP=#1000
0003 EA46=      NUMA=#EA46
0004 E97A=      OUTPUT=#E97A
0005 E83E=      BLANK=#E83E
0006 E973=      REDOUT=#E973
0007 EA13=      CRLW=#EA13
0008 E1A1=      COMIN=#E1A1
0009 E83E=      BLANK=#E83E
0010 CE85=      BASTBL=#CE85
0011 B27F=      BASIC6=#B27F
0012 00F0=      ADL=#F0
0013 00F1=      ADH=#F1
0014 00F2=      TCNT=#F2
0015 00F3=      TPAR=#F3
0016 00F4=      PECNT=#F4
0017 00F5=      CNT=#F5
0018 00F6=      PTR=#F6
0019 00F8=      LINLOW=#F8
0020 00F9=      LINHI=#F9
0021 00FA=      OLDL=#FA
0022 00FB=      OLDH=#FB
0023 00BE=      TABLE=#BE
0024 0073=      PGMST=#73
0025 00FE=      PAR=#FE
0026 A800=      TAPE=#A800

0028 0000      **$10C
0029 010C 4C 00 02      JMP START

0031 010F      **$200
0032 0200 A9 37      START LDA #37      ;SET UP TAPE INPUT
0033 0202 80 02 A8      STA TAPE+2
0034 0205 A9 EE      LDA #EE
0035 0207 80 0C A8      STA TAPE+12
0036 020A 20 94 03      NEXT   JSR PETCAS      ;READ PET TAPE
0037 0200 80 6A 04      LDA FLAG      ;LEADER = #01
0038 0210 C9 01      CMP #01      ;LEADER?
0039 0212 20 13 EA      JSR CRLW
0040 0215 20 13 EA      JSR CRLW
0041 0218 D0 F0      BNE NEXT

0043 021A 20 89 03      JSR OFFON      ;TURN OFF TAPE
0044 021D A2 00      LDX #00      ;OUTPUT NAME OF FILE
0045 021F 80 5F 04      NAME LDA FILE,X
0046 0222 C9 20      CMP #?
0047 0224 F0 06      BEQ LEN      ;LOOK FOR BLANK AT END
0048 0226 20 7A E9      JSR OUTPUT
0049 0229 E8      INX
0050 022A D0 F3      BNE NAME      ;GET NEXT LETTER
0051 022C 20 3E E8      LEN   JSR BLANK

0053 022F 18      CLC      ;OUTPUT NECESSARY MEMORY
0054 0230 AD 6D 04      LDA END      ;FOR PROGRAM
0055 0233 69 62      RDC #62
0056 0235 80 60 04      STA END
0057 0238 AD 6E 04      LDA END+1
0058 023B 69 00      RDC #00
0059 023D 20 46 EA      JSR NUMA      ;OUTPUT IT
0060 0240 AD 6D 04      LDA END
0061 0243 20 46 EA      JSR NUMA
0062 0246 20 3E E8      JSR BLANK

0064 0249 20 73 E9      JSR REDOUT      ;GET A CHARACTER
0065 024C 20 89 03      JSR OFFON      ;TURN ON TAPE
0066 024F C9 59      CMP #?Y
0067 0251 F0 05      BEQ GO
0068 0253 80 6A 04      STA FLAG      ;CHANGE FLAG'S VALUE
0069 0256 D0 B2      BNE NEXT      ;READ NEXT FILE ON TAPE

0071 0258 A9 08      GO    LDA #08
0072 025A 85 F5      STA CNT
0073 025C A2 FF      DELAY1 LDX #FF
0074 025E A0 FF      DELAY2 LDY #FF
0075 0260 88      DELAY3 DEY
0076 0261 D0 FD      BNE DELAY3
0077 0263 CA      DEX
0078 0264 D0 F8      BNE DELAY2
0079 0266 C6 F5      DEC CNT
0080 0268 D0 F2      BNE DELAY1

0082 026A 20 94 03      JSR PETCAS      ;READ PROGRAM BODY
0083 026D C8      INY
0084 026E 8C 69 04      STY FLAG-1
0085 0271 20 13 EA      JSR CRLW
0086 0274 C6 F4      DEC PECHT      ;ONE ERROR WILL BE COUNTED
0087 0276 A5 F4      LDA PECHT      ;AT THE END OF THE PROGRAM
0088 0278 20 46 EA      JSR NUMA      ;OUTPUT NO. OF PARITY ERRORS
0089 027B 20 3E E8      JSR BLANK
0090 027E 89 08 04      ERRS LDA MSG,Y
0091 0281 48      PHA
0092 0282 20 7A E9      JSR OUTPUT
0093 0285 C8      INY
0094 0286 68      PLA
0095 0287 10 F5      BPL ERRS

0097 0289 A2 04      LDX #DBASTRT
0098 028B 86 F6      STX PTR
0099 028D 86 73      STX PGMST
0100 028F A9 68      LDA #CBASTRT
0101 0291 85 F7      STA PTR+1
0102 0293 85 74      STA PGMST+1

0104 0295 20 13 EA      REENTR JSR CRLW
0105 0298 D0 0F      BNE FIRST
0106 029A 20 22 03      JSR INCPTR
0107 029D A2 00      LDX #00
0108 029F C8      INY
0109 02A0 A5 F6      LDA PTR
0110 02A2 81 FA      STA (OLDL,X)
0111 02A4 A8      TRX
0112 02A5 A5 F7      LDA PTR+1
0113 02A7 91 FA      STA (OLDL),Y

0115 02A9 85 FB      FIRST STA OLDH
0116 02AB 86 FA      STX OLDL
0117 02AD 20 22 03      JSR INCPTR
0118 02B0 D0 03      BNE MORE
0119 02B2 4C 2D 03      JMP BASICS

0121 02B5 20 22 03      MORE   JSR INCPTR      ;CONVERT LINE NO. TO DECIMAL
0122 02B8 85 F8      STA LINLOW
0123 02BA 20 22 03      JSR INCPTR
0124 02BD 85 F9      STA LINHI
0125 02BF A2 00      LDX #00      ;AND PRINT IT OUT
0126 02C1 A5 F8      SUBMEM LDA LINLOW      ;Y=0 FROM INCPTR SUBROUTINE
0127 02C3 38      SEC      ;SUBTRACT MULTIPLES OF 10 FROM
0128 02C4 F9 0E 04      SBC SUBTBL,Y      ;THE LINE NO. STARTING WITH 10000
0129 02C7 85 F8      STA LINLOW
0130 02C9 A5 F9      LDA LINHI
0131 02CB C8      INY
0132 02CC F9 0E 04      SBC SUBTBL,Y
0133 02CF 90 07      BCC ADBACK      ;SUBTRACTED ONE TOO MANY
0134 02D1 85 F9      STA LINHI
0135 02D3 E8      INX
0136 02D4 88      DEY
0137 02D5 4C 01 02      JMP SUBMEM      ;DO IT AGAIN WITH THE SAME VALUE

0139 02D8 88      ADBACK DEY
0140 02DA A5 F8      LDA LINLOW
0141 02DB 79 0E 04      ADC SUBTBL,Y
0142 02DE 85 F8      STA LINLOW
0143 02E0 88      INY
0144 02E1 09 30      ORA #30
0145 02E3 20 7A E9      JSR OUTPUT
0146 02E6 C8      INY
0147 02E7 C8      INY
0148 02E8 C0 08      CPY #08
0149 02EA D0 D3      BNE NXTDIG

0151 02EC A5 F8      LDA LINLOW
0152 02EE 09 30      ORA #30
0153 02F0 20 7A E9      JSR OUTPUT
0154 02F3 20 3E E8      JSR BLANK

0156 02F6 20 22 03      LOOP1 JSR INCPTR      ;GET NEXT BYTE
0157 02F9 F0 9A      PHR      ;END OF LINE
0158 02FB 48      PHR
0159 02FC C9 22      CMP #?
0160 02FE D0 0C      BNE CONT1
0161 0300 68      PLA
0162 0301 20 22 03      LOOP1A JSR INCPTR
0163 0304 F0 8F      BEQ REENTR
0164 0306 C9 22      CONT3 CMP #?
0165 0308 D0 F7      BNE LOOP1A
0166 030A F0 EA      BEQ LOOP1
0168 030C 68      CONT1 PLA
0169 030D 10 E7      BPL LOOP1
0170 030F A8      TRX
0171 0310 BD 96 03      LDA TOKTBL-128,X
0172 0312 30 09      BMI CONT4
0173 0315 8A      TRX

0174 0316 20 46 EA      JSR NUMA
0175 0319 20 3E E8      JSR BLANK
0176 031C A9 0E      LDA #EE
0177 031E 91 FE      CONT4 STA (PTR),Y
0178 0320 D0 04      BNE LOOP1
0180 0322 E6 F6      INCPTR INC PTR
0181 0324 D0 02      BNE INCPTR1
0182 0326 E6 F7      INC PTR+1
0183 0328 A0 00      INCPTR1 LDY #00
0184 032A 81 F6      LDA (PTR),Y
0185 032C 60      RTS

0187 032D 20 22 03      BASICS JSR INCPTR      ;MAKE PTR LOOK PAST THE
0188 0330 A6 F6      LDX PTR      ;LAST THREE ZEROS AND
0189 0332 A5 F7      LDA PTR+1
0190 0334 86 75      STX #75
0191 0336 85 76      STA #76
0192 0338 A2 00      LDX #CRAMTOP
0193 033A A9 18      LDA #RAMTOP
0194 033C 86 7F      STX #7F
0195 033E 85 80      STA #80
0196 0340 A2 FE      LDX #EFE
0197 0342 9A      TXS
0198 0344 A9 00      LDA #00
0199 0346 48      PHR
0200 0348 85 81      STA #81
0201 034A 85 82      STA #82
0202 034C 85 83      STA #83
0203 034E 85 84      STA #84
0204 034F A2 1C      LDX #1C
0205 0350 BD 85 CE      L1   LDA BASTBL,X
0206 0353 85 BE      STA TABLE,X
0207 0355 CA      DEX
0208 0356 D0 F8      BNE L1
0209 0358 A9 03      LDA #03
0210 035A 85 88      STA #88
0211 035C A9 61      LDA #61
0212 035E 85 8E      STA #8E
0213 0360 A9 89      LDA #89
0214 0362 85 82      STA #82
0215 0364 A9 14      LDA #14
0216 0366 85 12      STA #12
0217 0368 A9 0A      LDA #0A
0218 036A 85 11      STA #11
0219 036C A9 E1      LDA #E1
0220 036E 85 82      STA #82
0221 0370 A9 4C      LDA #4C
0222 0372 85 00      STA #00
0223 0374 85 03      STA #03
0224 0376 85 9C      STA #9C
0225 0378 85 BB      STA #BB
0226 037A A2 87      LDA #87
0227 037C A9 8F      LDA #8F
0228 037E 86 8C      STX #8C
0229 0380 85 8D      STA #8D
0230 0382 86 84      STX #84
0231 0384 85 85      STA #85
0232 0386 4C 7F B2      JMP BASIC6      ;JMP TO BASIC WARM START

0234 0389 48      OFFON PHR
0235 038A AD 80 A8      LDA TAPE
0236 038C 49 38      EOR #38
0237 038F 8D 80 A8      STA TAPE
0238 0392 68      PLA
0239 0393 60      RTS

0241 0394 A9 04      PETCAS LDA #LOAD
0242 0396 85 F1      STA RDH
0243 0398 A9 61      LDA #CLOAD
0244 039A 85 F8      STA RD
0245 039C A9 02      LDA #02
0246 039E 85 F4      STA PECHT
0247 03A0 20 C5 03      PETCA JSR GETY
0248 03A3 30 03      BMI PETX
0249 03A5 4C 94 03      JMP PETCAS
0250 03A8 C6 F4      DEC PECHT
;GET IN SVNCH WITH TAPE
;READ SHORTS?
;NO. TRY AGAIN
;TWICE?

```

```

0251 03AA D0 F4      BNE PETCA ;NO. GO DO AGRIN
0252 03AC 20 C5 03  PETCB JSR GBYTE ;READ THE REST OF THE LEADER
0253 03AF 30 FB      BMI PETCB ;STILL SHORTS
0254 03B1 B0 04      PETCC BCS PETCD ;IF CARRY IS SET THEN NO
0255 03B3 A9 FE      LDA #PAR ;PARITY ERROR
0256 03B5 E5 F4      INC PECNT INC PECNT
0257 03B7 91 F0      PETCD STA (ROL),Y ;Y=0
0258 03B9 E6 F0      INC RDL ;INC INDIRECT ADDRESS
0259 03BB D0 02      BNE PETCE
0260 03BD E6 F1      INC ADH INC ADH
0261 03BF 20 C5 03  PETCE JSR GBYTE ;READ NEXT BYTE
0262 03C2 10 ED      BPL PETCC ;PLUS MEANS THAT IT'S NOT SHORTS
0263 03C4 60          RTS ;SHORTS MEAN FILE IS DONE

0265 03C5 A0 11      GBYTE LDY #11 ;NO. OF SHORTS
0266 03C7 20 F9 03  GBA JSR GETTR ;GET TRANSITIONS
0267 03CA E0 40      CPX #40 ;IS IT A LONG?
0268 03CC B0 08      BCS GBB ;YES, GO READ BYTE
0269 03CE E0 2C      CPX #2C ;IS IT A SHORT?
0270 03D0 B0 F3      BCS GBYTE ;NO. GET IN SYNCH
0271 03D2 88          DEY ;COUNT SHORTS
0272 03D3 10 F2      BPL GBA ;COUNT SHORTS
0273 03D5 60          RTS

0275 03D6 A0 09      GBB LDY #09 ;BIT COUNT PLUS PARITY
0276 03D8 84 F2      STY TPAR ;PARITY COUNTER
0277 03DA 20 F9 03  JSR GETTR ;WASTE LAST HALF OF START BIT
0278 03DD 20 EE 03  GBC JSR GETBIT ;BIT VALUE IN C
0279 03E0 90 02      BCC GBD ;0?
0280 03E2 E6 F3      INC TPAR ;=1 SO INC PARITY COUNT
0281 03E4 6A          ROR A ;ROLL INTO BYTE AT MSB
0282 03E5 88          DEY ;9 YET
0283 03E6 D0 F5      BNE GBC ;NO
0284 03E8 2A          ROL A ;LOSE PARITY BIT
0285 03E9 49 FF      EOR #FF ;INVERT
0286 03EB 46 F3      LSR TPAR ;PUT PARITY IN C
0287 03ED 60          RTS

0289 03EE 20 F9 03  GETBIT JSR GETTR ;GET FIRST TRANSITION
0290 03F1 86 F2      STX TCNT ;GET SECOND TRANSITION
0291 03F3 20 F9 03  JSR GETTR ;COMPARE, C= BIT
0292 03F6 E4 F2      CPX TCNT
0293 03F8 60          RTS

;THE PET CASSETTE FORMAT
0295 03F9 ;IS PHASE DEPENDENT. SOME RECORDERS MAY
0296 03F9 ;INADVERTENTLY INVERT THIS SIGNAL. TO
0297 03F9 ;CORRECT THIS, CHANGE THE FOLLOWING INSTRUCTIONS:
0298 03F9 ;
0299 03F9 ; 'BMI GETA' TO 'BPL GETA'
0300 03F9 ; 'BPL GETB' TO 'BMI GETB'
0301 03F9 ;
0302 03F9 A2 00      GETTR LDY #00 ;X= NO. OF CYCLES THRU LOOPS
0303 03FB E8          INX
0304 03FC 2C 00 A8  BIT TAPE ;CHECK PB?
0305 03FF 30 FA      GETB BMI GETA ;LOOP UNTIL LOW
0306 0401 E8          INX
0307 0402 2C 00 A8  BIT TAPE
0308 0405 10 FA      BPL GETB ;LOOP UNTIL HIGH AGRIN
0309 0407 60          RTS
0310 0408 45 52      MSG .BYT 'ERROR',#03
0311 0409 D3          SUBTBL WOR 10000 ;POWERS OF 10 TABLE
0312 040E 10 27      WOR 1000
0313 0412 64 00      WOR 100
0314 0414 0A 00      WOR 10
0315 0416 80          TOKTBL BYT 128,129,130,131,132
0316 0418 82          .BYT 0,133,134,135,136,137,138
0317 0419 83          .BYT 139,140,141,142,143,144,146
0318 041A 84          .BYT 152,153,154,0,0,0,0
0319 041B 85          .BYT 155,156,157,158,159,160
0320 041C 86          .BYT 161,162,163,164,165,166
0321 041D 87          .BYT 167,168,169,170,171,172,173,174
0322 041E 88          .BYT 175,176,177,178,179,180
0323 041F 89          .BYT 181,182,183,184,185,186,187
0324 0420 8A          .BYT 188,189,190,191,192,193,194,195,196
0325 0421 8B          .BYT 188,189,190,191,192,193,194,195,196
0326 0422 8C          .BYT 188,189,190,191,192,193,194,195,196
0327 0423 8D          .BYT 188,189,190,191,192,193,194,195,196
0328 0424 8E          .BYT 188,189,190,191,192,193,194,195,196
0329 0425 8F          .BYT 188,189,190,191,192,193,194,195,196
0330 0426 90          .BYT 188,189,190,191,192,193,194,195,196
0331 0427 91          .BYT 188,189,190,191,192,193,194,195,196
0332 0428 92          .BYT 188,189,190,191,192,193,194,195,196
0333 0429 93          .BYT 188,189,190,191,192,193,194,195,196
0334 042A 94          .BYT 188,189,190,191,192,193,194,195,196
0335 042B 95          .BYT 188,189,190,191,192,193,194,195,196
0336 042C 96          .BYT 188,189,190,191,192,193,194,195,196
0337 042D 97          .BYT 188,189,190,191,192,193,194,195,196
0338 042E 98          .BYT 188,189,190,191,192,193,194,195,196
0339 042F 99          .BYT 188,189,190,191,192,193,194,195,196
0340 0430 9A          .BYT 188,189,190,191,192,193,194,195,196
0341 0431 9B          .BYT 188,189,190,191,192,193,194,195,196
0342 0432 9C          .BYT 188,189,190,191,192,193,194,195,196
0343 0433 9D          .BYT 188,189,190,191,192,193,194,195,196
0344 0434 9E          .BYT 188,189,190,191,192,193,194,195,196
0345 0435 9F          .BYT 188,189,190,191,192,193,194,195,196
0346 0436 A0          .BYT 188,189,190,191,192,193,194,195,196
0347 0437 A1          .BYT 188,189,190,191,192,193,194,195,196
0348 0438 A2          .BYT 188,189,190,191,192,193,194,195,196
0349 0439 A3          .BYT 188,189,190,191,192,193,194,195,196
0350 043A A4          .BYT 188,189,190,191,192,193,194,195,196
0351 043B A5          .BYT 188,189,190,191,192,193,194,195,196
0352 043C A6          .BYT 188,189,190,191,192,193,194,195,196
0353 043D A7          .BYT 188,189,190,191,192,193,194,195,196
0354 043E A8          .BYT 188,189,190,191,192,193,194,195,196
0355 043F A9          .BYT 188,189,190,191,192,193,194,195,196
0356 0440 AA          .BYT 188,189,190,191,192,193,194,195,196
0357 0441 AB          .BYT 188,189,190,191,192,193,194,195,196
0358 0442 AC          .BYT 188,189,190,191,192,193,194,195,196
0359 0443 AD          .BYT 188,189,190,191,192,193,194,195,196
0360 0444 AE          .BYT 188,189,190,191,192,193,194,195,196
0361 0445 AF          .BYT 188,189,190,191,192,193,194,195,196
0362 0446 B0          .BYT 188,189,190,191,192,193,194,195,196
0363 0447 B1          .BYT 188,189,190,191,192,193,194,195,196
0364 0448 B2          .BYT 188,189,190,191,192,193,194,195,196
0365 0449 B3          .BYT 188,189,190,191,192,193,194,195,196
0366 044A B4          .BYT 188,189,190,191,192,193,194,195,196
0367 044B B5          .BYT 188,189,190,191,192,193,194,195,196
0368 044C B6          .BYT 188,189,190,191,192,193,194,195,196
0369 044D B7          .BYT 188,189,190,191,192,193,194,195,196
0370 044E B8          .BYT 188,189,190,191,192,193,194,195,196
0371 044F B9          .BYT 188,189,190,191,192,193,194,195,196
0372 0450 BA          .BYT 188,189,190,191,192,193,194,195,196
0373 0451 BB          .BYT 188,189,190,191,192,193,194,195,196
0374 0452 BC          .BYT 188,189,190,191,192,193,194,195,196
0375 0453 BD          .BYT 188,189,190,191,192,193,194,195,196
0376 0454 BE          .BYT 188,189,190,191,192,193,194,195,196
0377 0455 BF          .BYT 188,189,190,191,192,193,194,195,196
0378 0456 C0          .BYT 188,189,190,191,192,193,194,195,196
0379 0457 C1          .BYT 188,189,190,191,192,193,194,195,196
0380 0458 C2          .BYT 188,189,190,191,192,193,194,195,196
0381 0459 C3          .BYT 188,189,190,191,192,193,194,195,196
0382 045A C4          .BYT 188,189,190,191,192,193,194,195,196

```

```

0325 0459 BD
0326 045A BE
0327 045B BF
0328 045C C0
0329 045D C1
0330 045E C2
0331 045F C3
0332 0460 C4

```

```

0327 0461 ;TO CHANGE THE LOCATION THAT
0328 0461 ;THE BASIC PROGRAM IS
0329 0461 ;STORED IN. CHANGE THE
0330 0461 ;LOCATION OF THESE FLAGS.
0331 0461 ;IE. ==#2000
0333 0461 LOAD ==#+9
0334 046A FLAG ==#+1
0335 046B BRSTR ==#+2
0336 046D END ==#+2
0337 046F FILE ==#+1
0338 0470 ZZZ END

```

ERRORS=0000 <0000>

SYMBOL TABLE

ADBACK	02D8	ADH	00F1	ADL	00F8	BASIC6	027F
BASIC5	032D	BASTEL	CE05	BASTRT	046B	BLANK	030E
CNT	00F5	COMIN	E1A1	CONT	02FB	CONT1	030C
CONT3	0306	CONT4	031E	CROW	E1A3	DELRV1	029C
DELRV2	025E	DELRV3	0260	END	046D	ERRS	027E
FILE	046F	FIRST	02A9	FLAG	046A	GBA	03C7
GBB	03D6	GBC	03DD	GBD	03E4	GBYTE	03C5
GETA	03FB	GETB	0401	GETBIT	03EE	GETTR	03F9
GO	0258	INCP1	0328	INCPTR	0322	L1	0350
LEN	022C	LINH1	00F9	LINLOW	00F8	LOAD	0461
LOOP1	02F6	LOOP1A	0301	MORE	02B5	MSG	0408
NAME	021F	NEXT	020A	NUMA	E4A6	NKTDIG	02BF
OFFON	0389	OLDH	00FB	OLDL	00FA	OUTPUT	E97A
PAR	00FE	PECNT	00F4	PETCA	03A0	PETCAS	0394
PETCB	03AC	PETCC	03B1	PETCD	03B7	PETCE	03BF
PETCY	03B6	FGNST	0073	PTR	00F6	RMTOP	1000
REOUT	E973	REENTR	0295	START	0200	SUBMEM	02C1
SUBTEL	040E	TABLE	00BE	TAPE	A800	TCNT	00F2
TOKTEL	0416	TPAR	00F3	ZZZ	0470		
END OF ASSEMBLY							

**KIMSI
FLOPPY
DISKS—**

**PERRY PERIPHERALS HAS
THE HDE MINIFLOPPY TO KIMSI
ADAPTER**

MINIFLOPPY S-100 ADAPTER: \$15

- FODS and TED Diskette
- FODS and TED User Manuals
- Complete Construction Information

OPTIONS:

- FODS Bootstrap in EPROM (1st Qtr'80)
- HDE Assembler (ASM) \$75
- HDE Text Output Processor (TOPS) \$135

(N.Y. State residents add 7% Sales Tax)

Place your order with:
PERRY PERIPHERALS
P.O. Box 924
Miller Place, N.Y. 11764
(516) 744-6462

Your "Long Island" HDE Distributor
KIMSI, a product of Forethought Products

REVIEW

KIMEX-1

PROM, RAM and I/O Expansion for the KIM

Harvey B. Herman

Digital Engineering Associates \$139.95
 P. O. Box 207
 Bethlehem, PA 18016

Those of us who have cut our computer baby teeth on the KIM have longed to have some of the capabilities of SYM (a newer, single-board computer) without, heaven forbid, having to throw out our first love. Digital Engineering Associates has come to our rescue with their product KIMEX-1. They are marketing a single-board add-on module which plugs into the KIM expansion interface and requires 6 wires to be soldered to the KIM application connector. The following features are standard:

1. Sockets for 4K of RAM (4118) contiguous with KIM's 1K RAM.
2. A 6522 VIA with I/O lines brought out to a separate connector.

3. Sockets for four 2716 5VEPROMs which can be selectively vectored to on power up.

The last item is really neat as this should greatly simplify operation of applications programs in EPROM by users unfamiliar with KIM.

The module appears to my eye very well designed and professionally constructed. It was trivial to connect to a basic KIM (15 minutes or less). For review purposes only, the company provided a clock program on EPROM which is described as an example in their 19-page manual. I turned on power (an extra 300 mamp from the 5V supply is necessary) and I was into the clock program and counting. Their program makes use of the 6522 VIA on board (a data sheet on the 6522 is also included with the manual). I am only just beginning to appreciate the "versatility" of the VIA chip and missed having one on the original KIM. Now's my chance.

The negative points are minor. I believe it may be more difficult and/or expensive to obtain a MOSTEK 4118 (1K x 8) than a 2114 (1K x 4), for example. Furthermore, it might have been helpful in some systems to address the 4K of RAM anywhere in memory. Other than that, I think the module is a pretty good deal for KIM owners who need its features, and I recommend it to them.

©

6502 FORTH

- * 6502 FORTH IS A COMPLETE PROGRAMMING SYSTEM WHICH CONTAINS AN INTERPRETER/COMPILER AS WELL AS AN ASSEMBLER AND EDITOR.
- * 6502 FORTH RUNS ON A KIM-1 WITH A SERIAL TERMINAL. (TERMINAL SHOULD BE AT LEAST 64 CHR. WIDE)
- * ALL TERMINAL I/O IS FUNNELLED THROUGH A JUMP TABLE NEAR THE BEGINNING OF THE SOFTWARE AND CAN EASILY BE CHANGED TO JUMP TO USER WRITTEN I/O DRIVERS.
- * 6502 FORTH USES CASSETTE FOR THE SYSTEM MASS STORAGE DEVICE
- * CASSETTE READ/WRITE ROUTINES ARE BUILT IN (INCLUDES HYPER-TAPE).
- * 92 OP-WORDS ARE BUILT INTO THE STANDARD VOCABULARY.
- * EXCELLENT MACHINE LANGUAGE INTERFACE.
- * 6502 FORTH IS USER EXTENSIBLE.
- * 6502 FORTH IS A TRUE IMPLEMENTATION OF FORTH ACCORDING TO THE CRITERIA SET DOWN BY THE FORTH INTEREST GROUP.
- * SPECIALIZED VOCABULARIES CAN BE DEVELOPED FOR SPECIFIC APPLICATIONS.
- * 6502 FORTH RESIDES IN 8K OF RAM STARTING AT \$2000 AND CAN OPERATE WITH AS LITTLE AS 4K OF ADDITIONAL CONTIGUOUS RAM.

6502 FORTH PRICE LIST

KIM CASSETTE, USER MANUAL, AND COMPLETE ANNOTATED SOURCE LISTING (\$2000 VERSION)	\$90.00 PLUS S&H 4.00
USER MANUAL (CREDITABLE TOWARDS SOFTWARE PURCHASE)	\$15.00 PLUS S&H 1.50

SEND A S.A.S.E. FOR A FORTH BIBLIOGRAPHY AND A COMPLETE LIST OF 6502 SOFTWARE, EPROM FIRMWARE (FOR KIM, SUPERKIM, AIM, SYM, AND APPLE) AND 6502 DESIGN CONSULTING SERVICES AVAILABLE.....

ERIC C. REHNKE
 540-61 SO, RANCH VIEW CR,
 ANAHEIM HILLS, CA 92807

Personal Computer Breakthrough

The Ohio Scientific Challenger 1 is a Dramatic Demonstration of Price and Performance in a Single Package

Announcing the microcomputer that scored a dramatic breakthrough in price and performance at a terrific system price!

Price/Performance Leader

The development of the Ohio Scientific Challenger 1P marked a price revolution for microcomputers. Consider the following features:

- (1) Microsoft 8K Basic-in-ROM
- (2) 4K RAM--Expandable to 8K on board
- (3) Full 53 Key keyboard with upper and lower case
- (4) Elaborate graphic display capability
- (5) Uses a standard cassette for input
- (6) Uses a standard television with an RF modulator for video output

All of these features makes the Challenger 1P a best buy for a beginner or hobbyist on a limited budget wishing to get involved with microcomputer, such as students & their educators, and various other professionals.

Already Looking Ahead??

Of course, we are not beginners forever (hopefully!!). What happens to the C1P then? Is it obsolete? That answer is a definite no!!

Consider the specification facts on the **expandability** of the Challenger 1P:

- (1) A fully expanded Challenger 1P can support:
 - (a) Basic-in-ROM
 - (b) 32K of RAM memory
 - (c) Dual Mini-floppies
 - (d) cassette
 - (e) printer
 - (f) modem
 - (g) full BUS expansion capability via the OSI 48 line BUS through which over 40 accessories can be added (A/D,D/A, voice output, I/O re memory, etc.)

As you can see, the Challenger 1P leaves more than adequate room for expansion. Thus, the system is not one you will have to 'get rid' of as you progress to more sophisticated computer functions.

Interested??

Here are the specifics for ordering the systems:

- (1) Freight and insurance are added to the cost of each package. Add \$6 for #1 and \$9 for #2 for delivery anywhere in the continental US. Overseas deliveries are available at a higher freight rate.
- (2) Funds transfers are handled easiest by money order or certified check, as this insures the quickest turnaround. Personal checks require 10-14 days to clear. Also, Visa & Mastercharge are accepted for your convenience.
- (3) All deliveries are made via UPS.
- (4) Warranty: A standard 60-day parts and labor warranty is in effect when purchased. After this period, parts are guaranteed for 1 year from purchase. Service work is done in-house whenever possible for a quick turnaround.
- (5) Want more information? Write for our OSI catalogs. Enclose \$2.00 for brochures & handling.

Challenger 1P with Disk Capabilities

If you are familiar enough with computers to realize the importance of disk storage, then the Challenger 1P Mini Floppy is a prime consideration.

At \$995, it is the first microcomputer system to offer disk storage capacity under \$1000, another breakthrough. The C1P MF offers the advantage of using either Basic-in-Rom or Pico-Dos, a compact DOS. The unit comes standard with 12K of RAM.

Additional memory can be added anytime by simply plugging in additional RAM into the socketed memory board. Upon adding 8K additional RAM to get to 20K, you may run OS65DV3.1, a full-fledged DOS allowing named program and data files as well as random and sequential access capabilities to these files.

Why System Packages?

Microcomputers are sophisticated devices that require more than the initial purchase. Once the purchase is made, a quick second, third, and even fourth trip is necessary to secure the accessories necessary to operate properly. To save you the additional trips, we have made two system packages available to the public at great savings.

System Package #1: Challenger 1P

- | | |
|----------------------------------|--------|
| (1) Challenger 1P w/4KRAM | 349.00 |
| (2) Additional 4K RAM(installed) | 69.00 |
| (3) Challenger 1P workbook | 7.00 |
| (4) Howard Sams schematics | 8.00 |
| (5) 3 Software tapes | 22.00 |
| (6) 10 blank data cassettes | 15.00 |
| Total List price | 470.00 |

CCSB System 1 Price 399.00

System Package #2: Challenger 1P MF

- | | |
|----------------------------------|---------|
| (1) Challenger 1P MF w/12K RAM | 995.00 |
| (2) Additional 8K RAM(installed) | 138.00 |
| (3) Challenger 1P workbook | 7.00 |
| (4) Howard Sams schematics | 8.00 |
| (5) OS65D V3.1 operating system | 50.00 |
| (6) 3 Software Tapes | 22.00 |
| (7) 10 blank diskettes | 35.00 |
| Total List Price | 1255.00 |

CCSB System 2 Price 1088.00

You will notice the system price reflects a **15% savings** over typical list price.

COMPUTER CENTER OF SOUTH BEND

51591 US 31 NORTH SOUTH BEND IN 46637 (219) 277-4655

Store Hours Mon-Saturday 12-8

Fast Tape Read/Write Programs for Your OSI

Edward H. Carlson
3872 Raleigh Dr.
Okemos, MI 48864

There are two surprises in store for owners of OSI C1 or C2 cassette based computers when they first turn to machine language programming. One shows up early on. After writing a program you want to save, you suddenly realize that there is no machine language write-tape routine included in ROM. There is a read-tape program. You need only enter the monitor with an M keystroke and follow it with an L keystroke, to be reading tape in OSI's standard format. (There are, of course, both read and write tape routines for BASIC-IN-ROM.)

The second surprise is that this tape format puts three bytes on tape to record one byte of data. The Kansas City tape standard used by OSI is very reliable, but 300 baud is not a very fast rate. One can hardly tolerate cutting this to an effective rate of 100 baud when recording machine language programs of moderate length or longer. In this article I will give routines that take the sting out of each of these surprises.

The OSI tape format mimics the keyboard as it inputs to the monitor program. That is, each byte is entered as two hex digits, in ASCII code. The monitor has two modes. A "." symbol puts it into a "read address" mode. Then the next two bytes are placed in memory at \$FE and treated as an address. A "/" symbol puts the monitor in the "accept text" mode. Then each byte entered is stored in temporary memory. When RETURN is received, the byte is moved to memory at the address stored in \$FE, and then this address is incremented by 1 so that the load process ratchets along in memory space. After all the text is loaded, a "." symbol puts the monitor back into the address mode. A new address is entered and then "G" starts execution at this address.

Listing 1 shows a BASIC program that takes machine code from memory and outputs it to tape in this format. I wrote this program with two uses in mind. First, you may need it to bootstrap the fast KC tape reader program into the machine. Second, it may serve as a relatively painless way for a machine language novice to save his or her creations. BASIC doesn't use the space in page \$02 from \$0222 to the end of the page. You can put

a short machine language program here and read it to tape using the BASIC program. The resulting tape can be read by entering the monitor and typing L. After reading, the machine will re-enter the monitor because of the address \$FE00 in ASCII code in line 105. You could change the address to \$0222 so just reading from tape will automatically enter and execute the program.

Listing 1

```

1 REM WRITE MACHINE LANGUAGE TAPES IN OSI FORMAT
2 REM      E. H. CARLSON
3 REM      3872 RALEIGH DR.
4 REM      OKEMOS MI 48864
5 N=221
6 M=3*N+15
7 Q=64512:R=Q+1
8 REM ACIA AT 64512=$FC00 IN 500 BOARD MACHINES
9 REM USE 61440=$F000 FOR 600 BOARD MACHINES
10 INPUT "START TAPE AND WAIT FOR LEADER. THEN INPUT G *":A$
100 DATA 46,48,50,50,50,47:REM .0222/
105 DATA 46,70,69,48,48,71:REM .FE00G
110 FOR I=1 TO 6:READ C:WAIT Q,2:POKE R,C:PRINT CHR$(C):NEXT
116 S=546:E=S+N
119 REM FOR I=$0222 TO $02FF
120 FOR I=S TO E
125 C=PEEK(I):H=C AND 240:L=C AND 15
130 H=H/16+48:IF H>57 THEN H=H+7
135 L=L+48:IF L>57 THEN L=L+7
136 WAIT Q,2:POKE R,H
137 WAIT Q,2:POKE R,L
138 WAIT Q,2:POKE R,13
145 PRINT CHR$(H):CHR$(L):" ";
150 NEXT I
155 FOR I=1 TO 6:READ C:WAIT Q,2:POKE R,C:PRINT CHR$(C):NEXT
160 REM FORMAT FOR TAPES IS:
165 REM .HLHL/HLRHLR...HLR.HLHLG
170 REM WHERE THE HLHL AT THE START IS THE STARTING ADDRESS,
175 REM HI BYTE FIRST, THE HLHL AT THE END IS THE EXECUTE
180 REM ADDRESS AND THE HLR'S IN THE MIDDLE ARE THE TEXT
185 REM BYTES, THE R BEING A CARRIAGE RETURN
190 REM THE . / G ARE THE SAME AS THE COMMANDS IN THE MONITOR
200 REM THE H AND THE L ARE ASCII CODE FOR THE HEX DIGITS
205 REM 0 THROUGH F.
210 REM FOR READ TAPE PROGRAMS USE
215 REM WAIT Q,1:X=PEEK(R)
OK

```

Actually, I wrote this BASIC program just recently. I usually use a machine language program obtained from the old OSI Small Journal, Vol. 1, number 5, November 1977. It is called "Cassette Loader and Memory Block Transfer". I had to convert it from using the UART of the 430 board to using the ACIA of the 500 board. This program has a nice screen display and I may add to its commands someday in order to make it into an extended monitor.

The grape vine soon tells the new OSI user that there is an "Auto-Load Cassette System" program available which does a check sum load for

OSI machine language programs. True enough, but would you believe it? It still uses the three bytes for one scheme! I wrote the programs of Listings 2 and 3 so as to have a reliable "fast" tape input and output routine with the check sum feature. They read 1K in 40 seconds.

The easiest way to understand the format is to look at the write program, Listing 2. The information stored on the tape consists of leader, addresses, text and check sum, in that order. Why a leader? My recorder has an automatic gain control when recording. This means that before the computer starts writing, the recorder, "hearing" nothing, turns up its gain control so high that the tape is filled with hisses and popping, which puts a lot of garbage bits on the tape. To avoid trying to read these as valid data, I write a leader: 3 bytes of \$0F. Only after reading 3 consecutive bytes of \$0F does the read program begin to read the tape in earnest.

Before writing a tape, you must use the monitor to put the start, end and execute addresses (in that order) in memory starting at address \$0000. For human convenience, these are ordered in the "sensible" way, with the most significant byte of each address first. The "execute" address can be any suitable program you are about to read from tape, or any other. The actual writing is done by a subroutine in the BASIC

Listing 2

```

10 0000      :      FAST KC TAPE WRITE
20 0000      :
30 0000      LEADER = $0F      BYTE WRITTEN 3 TIMES AS LEADER
40 0000      SCREEN = $D100    LOCATION IN SCREEN MEMORY
50 0000      WT = $BF15        WRITE BYTE IN A TO TAPE
60 0000      MONITR = $FE00    MONITOR
70 0000      START = $00       START ADDRESS IN H L ORDER
80 0000      END = $02         END ADDRESS IN H L ORDER
90 0000      EXECUT = $04      EXECUTE ADDRESS IN H L ORDER
100 0000     CURENT = $05      CURRENT ADDRESS IN L H ORDER
110 0000     CHKSUM = $08      CHECK SUM BYTE
120 0222     **=$0222
130 0222 A90F MAIN LDA #LEADER WRITE $0F 0F 0F
140 0224 2015BF JSR WT
150 0227 2015BF JSR WT
160 022A 2015BF JSR WT
170 022D A000 LDY #0
180 022F B90000 M1 LDA START.Y WRITE START, END, AND EXECUT
190 0232 2015BF JSR WT ADDRESSES. H L ORDER
200 0235 C8 INY
210 0236 C006 CPY #6
220 0238 D0F5 BNE M1
230 023A A500 LDA START INITIALIZE ADDRESS COUNTER
240 023C B507 STA CURENT+1
250 023E A501 LDA START+1
260 0240 B506 STA CURENT
270 0242 A000 TEXT LDY #0 WRITE TEXT . . .
280 0244 8408 STY CHKSUM
290 0246 B106 M2 LDA (CURENT).Y
300 0248 2015BF JSR WT WRITE TEXT BYTE
310 024B B000D1 STA SCREEN
320 024E 19 CLC
330 024F B508 ADC CHKSUM ADD TO CHECK SUM BYTE
340 0251 B508 STA CHKSUM
350 0253 A506 LDA CURENT LAST TEXT BYTE?
360 0255 C503 CMP END+1
370 0257 D006 BNE M3 NO, BRANCH AND CONTINUE
380 0259 A507 LDA CURENT+1 PERHAPS, TEST HI BYTE
390 025B C502 CMP END
400 025D F009 BEQ M5 YES, BRANCH AND WRITE ENDING
410 025F E606 M3 INC CURENT INCREMENT ADDRESS
420 0261 D002 BNE M4
430 0263 E607 INC CURENT+1
440 0265 4C4602 M4 JMP M2 WRITE ANOTHER BYTE OF TEXT
450 0268 A508 M5 LDA CHKSUM WRITE ENDING . . .
460 026A 2015BF JSR WT WRITE CHECK SUM BYTE
470 026D 4C0FE JMP MONITR

```

ROM at \$BF15. As the program writes, one display cell on the screen blinks and jitters as a copy of the transmitted byte is displayed in graphic symbols.

The check is 1 byte long. It is the sum of all the text bytes and is formed as the tape is made. The carry bit in these additions is ignored so it is a sum modulo \$100. This scheme for assuring yourself that you have a good load is suitable for cases where the error rate in writing and reading is not more than a few per tape. In fact, the OSI KC tape system is very reliable, and your errors, if any, are probably due to poor quality tape. I use the Microsette and the KL Electronics 10 minute tapes and have no problems. With low error rates, the chance that two or more errors will occur and also happen to cancel their effects on the check sum is negligible, and you can be confident that when the tape read program says the sum checks, you have a good load.

The read-tape program, Listing 3, is a little more complicated than the write-program. For debugging purposes, I output the letters N, L, A, T, and E to the screen to monitor progress in reading the tape. The N signifies that the tape program is looking at noise. There is also a dancing graphics character just as in the write program to indicate which bytes are being read. When a leader \$0F is seen, the L is written. Three L's put us into the address reading part of the program, signified by an A on the screen. Text follows, with a T put on the screen. When the load is done, a jump is immediately made to the execute address. However, if there is a check sum error, then the letter E for "error" is put on the screen and the read-tape program halts. If you have a 600 board machine, (a Superboard II or a C1) then your ACIA address is \$F000 instead of \$FC00.

Now for the autoloader feature. You would like to start with a cold machine and read your favorite long program in the fast tape format I gave above. But the only loader in a newly brought up machine is the OSI format tape reader. So you need to put our fast tape reader on your tape first, in the OSI format, then follow with your program in the fast tape format. The "execute" address of the OSI format load must be that of the first instruction in the fast tape program. How you accomplish this tandem load depends on how far along you are in your machine language system, that is, what utilities (if any) you may have. I will treat only the case which assumes that you are a rank beginner and have no utilities. It appears that things will be a bit awkward, but here goes. Bring up BASIC and enter the program of Listing 1. Test it by entering the monitor and putting a simple pattern in memory starting at \$0222 (for example; 00, 01, 02, 03 ... 0F, 10, 11, 12, ...) and then go back to BASIC and run Listing 1, making a tape. The screen shows what went on the tape. Save the BASIC program, clear memory and read your new tape in using the monitor L command.

Listing 3

```

10 0000      :      FAST KC TAPE READ
20 0000      :
30 0000      LEADER =50F      LEADER CHARACTER, 50F
40 0000      SCREEN =5D100    LOCATION ON MONITOR SCREEN
50 0000      ACIA =5FC00      6850 ACIA TAPE PORT
60 0000      START =500       HOLDS ADDRESS OF 1ST BYTE OF TEXT
70 0000      END =502         HOLDS ADDRESS OF LAST BYTE OF TEXT
80 0000      EXECUT =504      CONTAINS ADDRESS OF PROGRAM START
90 0000      CURENT =506      HOLDS ADDRESS OF CURRENT TEXT BYTE
100 0000     CHKSUM =508      CHECK SUM FROM TAPE STORED HERE
110 0000     COUNT =509       COMPUTED CHECK SUM AND OTHER STUFF
120 0222     **50222
130 0222 A94E LDA #*N      READING NOISE BEFORE LEADER
140 0224 8D02D1 STA SCREEN+2
150 0227 A000 MAIN LDY #0      READ LEADER, 50F 0F 0F
160 0229 8409 STY COUNT
170 022B 20A702 M1 JSR RT      READ TAPE BYTE
180 022E 8D00D1 STA SCREEN
190 0231 C90F CMP #LEADER IS IT A LEADER BYTE?
200 0233 D0F2 BNE MAIN NO, READ ANOTHER BYTE
210 0235 E609 INC COUNT YES, INCREMENT
220 0237 A94C LDA #*L      PRINT L FOR EVERY 50F READ
230 0239 9904D1 STA SCREEN+4,Y
240 023C C8 INY
250 023D A903 LDA #3      READ 3 OF THEM?
260 023F C509 CMP COUNT
270 0241 D0E8 BNE M1     NOT YET, READ ANOTHER
280 0243 A000 ADDR LDY #0      LEADER OVER, READ START,
290 0245 8409 STY COUNT END, EXECUTE ADDRESSES
300 0247 A941 LDA #*A
310 0249 8D00D1 STA SCREEN+8
320 024C 20A702 A1 JSR RT
330 024F 990000 STA START,Y
340 0252 8D00D1 STA SCREEN
350 0255 C8 INY
360 0258 C006 CPY #6
370 025B D0F2 BNE A1     BRANCH TO CONTINUE READING A
380 025A A500 LDA START SET INITIAL ADDRESS
390 025C 8507 STA CURENT+1
400 025E A501 LDA START+1
410 0260 8506 STA CURENT
420 0262 A000 TEXT LDY #0
430 0264 8409 STY COUNT CLEAR FOR CALC. CHECK SUM
440 0266 A954 LDA #*T
450 0268 8D00D1 STA SCREEN+10
460 026B 20A702 RBT JSR RT      READ A BYTE OF TEXT
470 026E 9106 STA (CURENT),Y
480 0270 8D00D1 STA SCREEN
490 0273 18 CLC
500 0274 6509 ADC COUNT COUNT ACCUMULATES CHECK SUM
510 0276 8509 STA COUNT
520 0278 A506 LDA CURENT TEST FOR END OF TEXT, LO
530 027A C503 CMP END+1
540 027C D006 BNE M3     NOT EQUAL, INC AND READ BYTE
550 027E A507 LDA CURENT+1 LO EQUAL, TEST HI
560 0280 C502 CMP END

```

Look at what memory contains. If all is well, you can move on to the next step, entering Listing 2 at \$0222 and saving it with the BASIC program. Likewise for listing 3. Running either of these programs clobbers page \$00 from \$00 to \$09 for BASIC. Further use of BASIC requires a cold start, unless you have saved the BASIC code from \$00 to \$09 on paper and enter it from the monitor. As an alternate, the temporary storage in the fast-read-write programs can be assigned to a part of page zero unused by BASIC, say \$E0 to \$E9.

After checking that these fast-tape programs are ok, your finger punching labor is over, but you will probably want to move (and modify) these programs so they don't overlap in memory. Here your own taste and interests enter and I can give no further instructions.

I will close with a note about program sources for machine language aficionados who have cassette based machines. I feel that one needs an assembler with editor, a disassembler, a mover-relocater, and a single

step-trace routine as well as these two fast tape programs.

There are some assemblers written in BASIC here and there in the journals. I don't know of any 6502 assembler written in machine language in the literature. I purchased the OSI 6500 Assembler Editor. Even before buying that program, I picked up the "6502 Disassembler from Apple" by Steve Wozniak and Allen Baum, Dr. Dobb's Vol. 2, number 8, 1976, page 249 in the reprint edition. Some modifications were required to input and output characters. The ROR correction they list has incorrect addresses. Correct them by subtracting 2 from the given addresses.

I use a program relocater by Ralph Sherman, in Dr. Dobb's, Vol. 2, number 4, April 1977, page 30. As usual, this program requires that you know where any tables are embedded in the code you wish to relocate. Never-the-less, it is very useful in taking programs scrounged from here and there and relocating them into a compact block.

I don't yet have a trace-single stepper, but I know where one exists. It's in the OSI Small Systems Journal, Vol. 2, number 1, page 11. It uses both the break point method (sprinkling \$00 commands in your code) and the SYNC pin method, which requires a minor hardware modification on your CPU board.

My computer is a C2-4P and the listings in this article were made on a COMPRINT 912P, driven by a 6522 on the 500 board, but that is another story. ©

OSI SOFTWARE FOR OHIO SCIENTIFIC

30 programs on tape, well documented, and available for C1 (Superboard) & C2 All Run in 4K and all except CHESS are in BASIC. Our new \$1.00 catalog has a free game listing, programming hints, and Pokes OSI forgot to mention.

- * CHESS FOR OSI \$19.95
(not in BASIC - specify system)
- * SUPERUTILITY \$12.95
has renumberer (also handles branch statements), variable table maker, and search routine.
- * TEN TANK BLITZ \$9.95
two players control 10 tanks in this video board game for War gamers. Real time action and complex strategy.
- * JOYSTICK PACKAGE \$19.95
4 programs - TANK, FIGHTER PILOT, KILLERBOT, & BARRIERBALL and free instructions for \$10.00 joystick conversion.
- * STARFIGHTER \$5.95
a real time space war game featuring a display with working instruments.

AARDVARK TECHNICAL SERVICES
1690 Bolton
Walled Lake, Michigan 48088
(313) 624-6316

Applications Review: Logic Analyzer For Kim

Roy Flacco
Physics Dept.
Drexel University
32nd and Chestnut
Phila. PA 19104

I have been using a logic analyzer on the KIM for some time and have become reasonably familiar with its applications (at least the simpler stuff) and appreciate the opportunity to share my experiences.

In its simplest form a Logic Analyzer (LA) consists of a memory, triggering logic, control circuitry, input latches, and output processing:

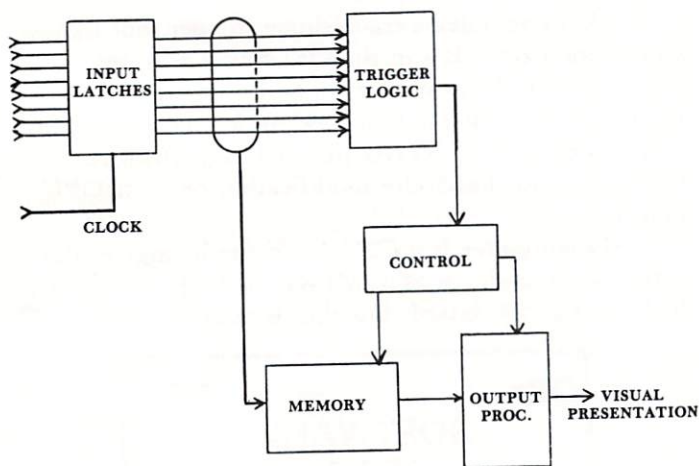

Basically, the LA latches a set of inputs, usually the Address and Data Buses every clock cycle (02) and stores them in a memory. Also, the trigger logic compares the logic state of these input lines with preset levels which are user-set. When the inputs match the presets, the LA "triggers" and does one of two things. If the LA is set to positive time, it stores in memory the logic levels present at the inputs for each clock cycle until the memory is full; or if the LA is set to negative time, it stops storing the inputs in memory (remember it has been storing all the previous states up till the trigger occurs, too.) Therefore, the memory now contains some number of data words representing successive words on the bus lines.

The LA now proceeds to display the data in the memory in some visually acceptable form. This has taken the form of strings of LED's, timing-diagram scope displays, etc., but the most useful by far is a numeric display (ones and zeroes) on a scope, at least to the software-debugging, hardware-soldering, wild-eyed amateurs of which group I am proudly a member.

Vastly more handy than a logic probe, the LA gives you a history of exactly what your machine did, cycle by cycle, in a form like the source listing it is hopefully trying to follow.

At present there is only one logic analyzer priced within the reach of the typical KIM owner: the Model 100A from Paratronics, Inc. This is available for \$229 from Jameco Electronics, (1355 Shoreway Rd. Belmont, CA 94002). It has an 8-bit by 16-word memory, can run at clock rates up to 8 MHz (mine just starts failing at 10 MHz so this is a conservative rating), works in both positive and negative time on positive-or negative-going clocks, will run from TTL, DTL, CMOS, MOS (input range from 0 to +15 volts) and outputs to the vertical and horizontal inputs of your scope. There are also a number of nice features such as an adjustable blanking signal to clarify the display and intensify the trigger word, and your choice of Hex or Octal display format. For example: 0000 0000 can be displayed as 00 000 000 if your code is written in octal.

The Model 100A, by itself, is useful but limited. First and most obviously, you are limited to 8 bits of triggering, and must move your input probes around if you wish to view data and address busses (which add up to 24 bits). The main application would be monitoring the data bus and checking that the proper data shows up on it in the proper sequence, or using it as a multi-input logic probe which can show you just how long that pulse lasted (the one that was stretched to 1/10 second on your hand-held model). But the thing to do is add the Model 10 Trigger Expander.

This lovely thing (also \$229 from James) sits happily across all the Address and Data lines (it presents roughly one LS-TTL load to the bus line), the 02 clock, and two other auxillary lines of your choosing (more later about these). Now see what you can do:

A Hexadecimal-coded thumbwheel switch (0000-FFFF) lets you choose the address trigger; if you desire you can also trigger from the data bus (00-FF using 0-X-1 paddle switches); you choose either the Data (DB) or the high or low order Address (ABH,ABL) to be stored in the memory via a paddle-switch controlled multiplexer (MUX). Along with all that, you now have DELAY capability, which allows you to examine the busses from 0 to 999 (decimal) clock cycles or program loop reps after the initial trigger. The closest approximation to this capability is a very elegant de-bugging program that allows you to set breakpoints within loops. But even so, the breakpoint routines don't allow you to see what's actually happening in a live run, and they depend on having all your hardware running well. The LA can be used

to find faults in the hardware such as stuck bits (a line that's always at logic 1 or 0), or other such problems that keep you from running at all.

The two auxillary lines are gated with the clock and the address trigger to allow you to "qualify" the trigger or the clock. This may be from the Read/Write line so that you only view those events that occur during a write to memory, or from the SYNC signal so that only OP CODE fetches are recorded. These signals may be derived from any convenient point in the KIM where they occur at the desired time to control the LA.

The Model 10 Trigger Expander connects to the Model 100A LA via a piece of ribbon cable, and to the Expansion Connector of the KIM (I recommend wiring a 44-pin edge connector just for the LA; it greatly simplifies use). Your scope hangs off the 100A. By the way, there is a TTL signal which lets you know when the LA has triggered; this is available at a BNC connector and may be used to trigger the sweep of your scope if you want to view voltage levels somewhere in the computer at a time defined by the program. It is terrific for catching glitches, slow rise times, overlapping clock pulses, and so on. When all the voltage levels are essentially the same it is much easier to trigger from the logic levels in combinations.

Now, insofar as the unit itself is concerned, mine was purchased as two kits (100A first, then 10).

Delivery was prompt (James has always been outstanding in my experience) and the kits were in good order: all parts present and accounted-for, all ICs carefully packed in foam, resistors etc. in bags, nothing loose. The assembly instructions and other documentation, something more than 250 pages with diagrams, pictorials, schematics and all, were superb. There is plenty of tutorial material, applications suggestions, a real professional job.

The kits were together easily in about 8 hours total. I have had some kit-building experience (a few Heathkits and an Eico scope) so I won't suggest that this is typical of a total novice, but with taking only reasonable care in assembly I managed to get it together without any real trouble. I will mention that the paddle switches were the only problem since they have to line up pretty exactly for proper mechanical alignment of the case. But then the real test:

It worked the first time I turned it on!

Now, those of us who only know KIMs don't appreciate the meaning of that statement, since KIMs are notoriously well-designed and seem to be darned hard to screw up. But for the rest of us, anything that has 40-odd ICs, about 100 resistors, a raft of capacitors, switches, and assorted oddities, plus three PC boards (glass epoxy with plated-thru holes by the way) is just about guaranteed not to function perfectly the

first time. Well, it did.

Moreover, it does everything it claims to do. Granted, there are so many different ways to use it, different combinations of controls and inputs, that it is difficult to say that every possible combination of functions is without flaw. I can say that I have used it for months, just about every day, without finding any failures.

Enough plaudits; what about drawbacks? OK, the display is in ones and zeroes. . . why not true hexadecimal. Cost, probably, and also versatility (remember it also wants to be able to display in octal) since it would require another ROM to do the character generation. There is one advantage to ones and zeros, tho', when you're looking for hardware problems. For instance, if you see the sequence: E37FA2B6 it is not obvious that bit 1 is stuck at logic 1, is it? It's a little bit easier like this:

```

1 1 1 0
0 0 1 1
0 1 1 1
1 1 1 1
1 0 1 0
0 0 1 0
1 0 1 1
0 1 1 0

```

but then again there are those of us who don't remember that 1 0 1 0 1 1 0 0 1 1 1 0 actually spells ACE. Well, if I can learn to convert from binary to hex, anybody can. It's definitely worth it.

The cost seem high? We have spent at least \$245 to get started with KIM, and before we're done I'll wager the average home system runs well over a grand, and probably more than that. What you must consider is that the LA is not limited to just examining the bus lines on your micro. It will do a fine job of general monitoring of any logic system, check out your incoming parts for proper functioning (it sure beats 1k resistors and LEDs for this), is a tremendous assist in the design of asynchronous logic (like TV typewriters and I/O devices in general), and the ability to have a record of what happened just before your 6502 flew off into upper memory and hid from you is really nice. There's just no other device that will do it. Oh, pardon me, there are other LAs on the market, but for one with the 100A/10's capabilities expect to spend 4 figures, not 3, and the first one won't be a "1" either. ©

try PSUEDO CODE

Eric Rehnke

Just got done reading an article called "Sketchcode" which was written up in the May-June issue of PEOPLES COMPUTERS. The purpose of the article (authored by Todd Voros) is to define a sort of

meta-language which itself can be used for designing structured programs and provide the programmer with a clear view of the flow of control within a program. This meta-language must be as applicable at high level (Basic, Fortran) as well as low level (assembler) programmers. Structured programming is sometimes known as GOTO-less programming.

Voros goes a long way in explaining the concepts and providing plenty of examples for this psuedo-code, which he dubs "sketchcode". Rather than try to describe the technique, here's an example:

```

COUNT = 1
DO WHILE (COUNT less than 11);
  PROCESS
  COUNT = COUNT + 1
END;

```

How's that for machine independent programming? Can you imagine how helpful it would be if all the magazines published this sort of documentation with every program that was published? By the way, an example program was presented in the article and converted from Sketchcode into both 8080 and 6502 assembly language just to be certain the reader has a complete understanding of this meta-language in a real implementation situation.

I have a couple of programs that I will try to rewrite using Sketchcode to clean up some very kludgy control flow. Maybe I'll present them in a later issue. ©

DISK DRIVE WOES? PRINTER INTERACTION? MEMORY LOSS? ERRATIC OPERATION? DON'T BLAME THE SOFTWARE!



ISO-1



ISO-2

Power Line Spikes, Surges & Hash could be the culprit! Floppies, printers, memory & processor often interact! Our unique ISOLATORS eliminate equipment interaction AND curb damaging Power Line Spikes, Surges and Hash.

- *ISOLATOR (ISO-1A) 3 filter isolated 3-prong sockets; integral Surge/Spike Suppression; 1875 W Maximum load, 1 KW load any socket \$54.95
- *ISOLATOR (ISO-2) 2 filter isolated 3-prong socket banks; (6 sockets total); integral Spike/Surge Suppression; 1875 W Max load, 1 KW either bank \$54.95
- *SUPER ISOLATOR (ISO-3), similar to ISO-1A except double filtering & Suppression \$79.95
- *ISOLATOR (ISO-4), similar to ISO-1A except unit has 6 individually filtered sockets \$93.95
- *ISOLATOR (ISO-5), similar to ISO-2 except unit has 3 socket banks, 9 sockets total \$76.95
- *CIRCUIT BREAKER, any model (add-CB) Add \$ 6.00
- *CKT BRKR/SWITCH/PILOT any model (-CBS) Add \$11.00

PHONE ORDERS 1-617-655-1532

Electronic Specialists, Inc.

171 South Main Street, Natick, Mass. 01760

Dept.pg

RNB Enterprises, Inc.
RNB ENTERPRISES, INC.

Yes, I want your catalog for AIM-65,
SYM-1, and KIM-1 expansion boards.

Eric C. Rehnke
I'm interested in software
for my KIM () SYM ()
AIM () APPLE ()

Falk-Baker Associates
Please send me your current
catalogue and price lists.

COMPUTE
Sign me up for compute II.
I am () am not () a
COMPUTE subscriber.

Enclosed: \$6.00 for compute subscriber.
\$9.00 for non-subscriber. \$6.00 offer expires
April 30, 1980. Canadian: \$9.00 and \$12.00
U.S. funds. Overseas see title page for rates.

COMPUTE'S BOOK CORNER

Please Send Me:
Best of the PET Gazette \$10.00
Collected PET User Notes \$10.00
(Seven Issues)

Collected 6502 User Notes
(Seventeen Issues) \$20.00

MC/Visa accepted. All orders add \$2.00
shipping and handling.

COMPUTE'S BOOK CORNER

Please send me:
Best of the PET Gazette \$10.00
Collected PET User Notes \$10.00
(Seven Issues)

Collected 6502 User Notes
(Seventeen Issues) \$20.00

MC/Visa accepted. All orders add \$2.00
shipping and handling.

Micro-Ed, Inc.

This coupon good now for
Five Dollars off price on
our MICRO-DOZEN ONE
package.

Or, save it for later, and send first for free
brochures with more information on our pro-
grams. We welcome suggestions for other
needed programs.

United Software of American
Programs From United
Software of America

are available at your local computer store or
directly from United Software of America.
Dealer inquiries welcomed.

COMPUTE
Free Issue with New
Subscriber

Please extend my subscription to COMPUTE ()
compute II () by one issue. (Attach your name
& zip code to new subscriber's request.) Offer
limited to subscribers. Expires as noted in ad on
page 97.

COMPUTE
Sign me up for compute II.
I am () am not () a
COMPUTE subscriber.

Enclosed: \$6.00 for compute subscriber.
\$9.00 for non-subscriber. \$6.00 offer expires
April 30, 1980. Canadian: \$9.00 and \$12.00 U.S.
funds. Overseas see title page for rates.

COMPUTE
Free Issue with New
Subscriber

Please extend my subscription to COMPUTE ()
compute II () by one issue. (Attach your name
& zip code to new subscriber's request.) Offer
limited to subscribers. Expires as noted in ad
on page 97.

Microphys Programs
Free Educational Software
Catalogue featuring Physics,
Chemistry, Math, Vocabu-
lary, and Spelling Programs

Send coupon with name and address to
Microphys Programs.

Skyles Electric Works
Good for One BIG Keyboard
@ \$99.50 or Two BIG
Keyboards @ \$189.50
Including USA Shipping

COMPUTE-Pon must accompany order. This
offer expires May 15, 1980. California
residents, please add appropriate sales tax.
Overseas, please add \$15.00 shipping.

RAYGAM, INC.
Join Now! 20% OFF!
Become a member of
RAYGAMCO Computer
Discount Club

and take advantage of the Charter Member's
Special - 20% OFF any purchase! Nothing to
buy to join. Send name and address for more
information.

Seawell Marketing, Inc.
Receive A 5% Discount
Regardless of the Size of
Your Order

To qualify, submit this COMPUTE-Pon
along with your order and payment. Master-
charge and VISA accepted. COD orders exempt.
Limit one COMPUTE-Pon per person. Expires
4/30/80

CMS Software Systems
STAR INTRUDERS for
PET by Commodore-Japan

This coupon good for one FREE STAR
INTRUDERS game with each software order
totaling \$15.00 or more. Offer expires
May 1, 1980. Specify 8K or 16K.

Electronic Specialists, Inc.
FREE MicroProcessor
INTERFERENCE CURE
flyer

Interference Control devices from Electronic
Specialists can clean up YOUR act! FREE
MicroProcessor interference control tips
flyer and catalog with this COMPUTE-Pon.

CONNECTICUT
microCOMPUTER Inc.
FREE - with this coupon -
1-TEMPENS2P1 Tempera-
ture Module with the
Purchase of a PETSET1,
KIMSET1, or APSET1.

See our ad in this issue. COMPUTE-Pon
expires April 30, 1980.

Skyles Electric Works
231 E. South Whisman Road
Mountain View, CA 94041

Micro-Ed, Inc.
P.O. Box 24156
Minneapolis, MN 55424

RNB Enterprises, Inc.
2967 W. Fairmont Ave.
Phoenix, AZ 85017

RAYGAM, INC.
6791 Westminster Avenue
Westminster, CA 92683

United Software of America
485 Lexington Ave.
New York, NY 10017

Eric C. Rehnke
540-61 S. Ranch View Circle
Anaheim, CA 92807

Seawell Marketing, Inc.
P.O. Box 30505
Seattle, WA 98103

Falk-Baker Associates
382 Franklin Avenue
Nutley, New Jersey 07110

CMS Software Systems
5115 Menefee Drive
Dallas, Texas 75227

COMPUTE
P.O. Box 5119
Greensboro, NC 27403

Electronic Specialists, Inc.
171 South Main Street
Natick, Mass 01760

COMPUTE
P.O. Box 5119
Greensboro, NC 27403

COMPUTE
P.O. Box 5119
Greensboro, NC 27403

CONNECTICUT
microCOMPUTER Inc.
150 Pocono Road
Brookfield, Connecticut
06804

Microphys Programs
2048 Ford Street
Brooklyn, NY 11229

COMPUTE
P.O. Box 5119
Greensboro, NC 27403

Softside Software

Buy groundbreaking
Symbolic/Structured Basic
and add action-packed
Driving Ace at special
price.

Take another look at our ad on the inside front.
If you buy disk-based Symbolic/Structured
Basic, take Driving Ace for \$4.95 with this
coupon.

Eastern House Software

10% OFF ON TRAP65
FROM EASTERN HOUSE
SOFTWARE FOR
COMPUTE SUBSCRIBERS

(see ad this issue)

Mail coupon with order for 10% off - For
more information, mail card with return
address. Offer expires 5/15/80.

COMPETITIVE SOFTWARE

PLEXI-VUE High Contrast
Viewing Screen for \$10.00
with Purchase of
SOFTPAC-1 at \$29.95

Offer limited to purchasers of SOFTPAC-1.
See our ad in this Issue. Special price to
COMPUTE readers: \$11.95 + \$1.00 shipping.
Regularly, \$14.95

Micro Software Systems

This COMPUTE-Pon good
for One Dollar credit toward
mail order purchase of MSS
software.

See MSS ad this issue for partial list of programs. Mail order offer expires April 30, 1980.
Send for copies of independent reviews and catalog.

Computhink

FOR IMMEDIATE
DELIVERY ON THESE
INEXPENSIVE PET
AND TRS-80 MEMORIES
AND DISK DRIVES

Send: () PET Disk Drive 400k, ()
PET Expandamentm 16k, 24k, 32k ()
PET Software information () TRS-80 400k
Disk Drive Check or money order, name &
address enclosed. Calif. Res. add 6% tax

Micro Technology Unlimited
Please RUSH me the Fall
1979 Catalog of 6502
expansion and application
products.

I have the following computer(s): Old Pet (),
New PET (), AIM-65 (), KIM-1 (),
SYM-1 ()

A B Computers

BASF DISKETTE SPECIAL
THROUGH APRIL 30, 1980

BASF 5 1/4" disks (certified 40 tracks)
10/\$27.50

BASF 8" disks 10/\$28.50

Quantity prices available. Specify sectoring
or machine requirements.

CGRS Microtech

DISK CONTROLLER/
\$100 EXPANSION KIT
for PET/KIM/SYM/AIM-
\$225.00 With 5 1/4" Drive -
\$515.00

Will work with the BETSI. Special adaptor
required for BETSI, KIM, SYM, AIM -
\$15.00 extra. Cables not included. Bare board -
145.00. Offer limited to May, 1980.

DTI OFFICE PRODUCTS, INC.
DTI - PROGRAMMED
FOR DEALER SUPPORT

DTI, a wholesale distributor for BASF,
Centronics, Commodore, SOROC, Xymec and
other products, welcomes dealer inquiries on any or
all of its top name lines.

CONNECTICUT

microCOMPUTER, Inc.

10% DISCOUNT with this
coupon on a KIMSET1
DATA ACQUISITION
SYSTEM

See our ad in this issue. COMPUTE-Pon expires
April 30, 1980

COMPUTE

Sign me up for compute II.
I am () am not () a
COMPUTE subscriber.

Enclosed: \$6.00 for compute subscriber.
\$9.00 for non-subscriber. \$6.00 offer expires
April 30, 1980. Canadian: \$9.00 and \$12.00
U.S. funds. Overseas see title page for rates.

DR. DALEY'S Software
This coupon good for \$5.00
discount on the
DR. DALEY'S 50-program
Software Library.

Offer valid only on purchases made through
your local computer store - none redeemed by
mail. Retailers call DR. DALEY'S
for details. Expires April 15, 1980.

Instant SoftwareTM Inc.

One dollar off any Instant
Software package purchased
at your local computer store
with this coupon.

Buyer-Write name, address, package number and
signature on front of coupon. Dealer-include
with next order for credit; limit one per package;
offer void where prohibited; expires 4/30/80

Cognitive Products

(PRO-GRESS +
TEXTCAST)* .74 =
\$BARGAIN

Order a word-processor and a regression
program together for savings. See the PRO-
GRESS ad in this issue.

COMPUTE

Free Issue with New
Subscriber

Please extend my subscription to COMPUTE ()
compute II () by one issue. (Attach your
name & zip code to new subscriber's request.)
Offer limited to subscribers. Expires as noted in ad
on page 97.

Typewriters Unlimited

This COMPUTE-Pon Worth
15% Toward the Mail
Order Purchase of Printer
Interfaces.

Typewriters Unlimited ad in this issue
describes the TU interfaces. Offer expires
April 30, 1980. Mail your order today.

COMPUTE'S BOOK CORNER

We Now Have One of the
Best Collections of 6502
Resource Materials Around:

COMPUTE'S BOOK CORNER

Please send me:-----

Best of the PET Gazette \$10.00
Collected PET User Notes \$10.00
(Seven issues)
Collected 6502 User Notes
(Seventeen Issues) \$20.00
MC/Visa accepted. All orders add \$2.00
shipping and handling.

Instant Software™ Inc.
Peterborough, NH 03458

A B Computers
115 E. Stump Road
Montgomeryville, PA 18936

Softside Software
305 Riverside Drive
New York, New York 10025

Cognitive Products
P.O. Box 2592
Chapel Hill, NC 27514

CGRS Microtech
P.O. Box 102
Langhorne, PA 19047

Eastern House Software
3239 Linda Drive
Winston-Salem, NC 27106

**DTI OFFICE
PRODUCTS, INC.**
8002-D Haute Court
Springfield, VA 22150

**COMPETITIVE
SOFTWARE**
21650 Maple Glen Drive
Edwardsburg, MI 49112

Typewriters Unlimited
1408 Idaho Street
Woodbridge, VA 22191

**CONNECTICUT
microCOMPUTER, Inc.**
150 Pocono Road
Brookfield, Connecticut
06804

Micro Software Systems
P.O. Box 1442
Woodbridge, VA 22193

Another last minute news note:
Commodore has announced the
three for two educational offer
is on again (effective 2/15/80).
Contact your local dealer for
full details.

COMPUTE
P.O. Box 5119
Greenboro, NC 27403

Computhink
965 West Maude
Sunnyvale, CA 94086

COMPUTE
P.O. Box 5119
Greensboro, NC 27403

DR. DALEY'S Software
425 Grove Ave.
Berrien Springs, MI 49103

Micro Technology Unlimited
P.O. Box 4596
841 Galaxy Way
Manchester, NH 03108



**PET-AIM
KIM-SYM**

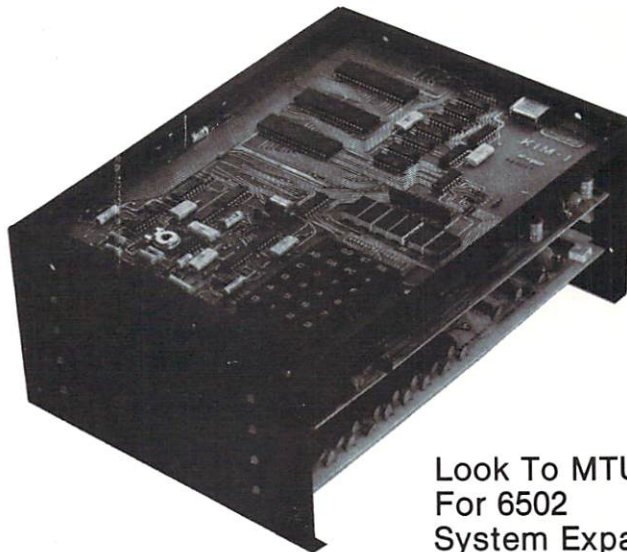

Look To MTU
For 6502
System Expansion



Micro Technology Unlimited

P.O. Box 4596, 841 Galaxy Way
Manchester, N.H. 03108
603-627-1464

Call Or Write For Our Full Line Catalog

WORDPRO BY commodore

Typewriters have come a long way since they were first introduced into offices. They've evolved from heavy-handed apparatus into the time saving electrics first used in the Fifties. Now the typewriter is the center of sophisticated, and often costly, office information systems.

Today, Commodore Business Machines, Inc., a leader in personal business systems, provides you with a cost-effective alternative to complex, cumbersome and expensive information systems. The Commodore

WordPro system — convenient, simple word processing — meets the needs of the business office of the Eighties.

With Commodore's versatile WordPro system, the time and effort saving benefits of word processing are a proven reality. The affordable Commodore WordPro system incorporates many user-suggested features to make operation as simple—and enjoyable—as possible.

And, WordPro grows with your changing business and paperwork

demands, allowing you to add other functions as your business expands. All without extensive hardware investments.

WordPro by Commodore offers the same features as large word processing systems ... instant editing, global search and replace, full document retention up to 170 pages on-line and much more!

WORDPRO WORKS FOR YOU



commodore

See Your Authorized Commodore Dealer today for a WORDPRO Demonstration.